

# C&K GP Series Sealed Ultraminiature Pushbutton Switches

## Features/Benefits

- Ultraminiature design saves space
- Process compatible, withstands most soldering and washing processes
- Thru-hole and surface mount models available
- Sealed construction—internal o-ring and epoxy base
- RoHS compliant

## Typical Applications

- Telecommunications and network equipment
- Computers and peripheral products
- Instrumentation

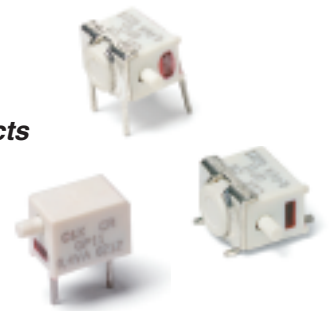

## Specifications

CONTACT RATING: 0.4 VA max. @ 20 V AC or DC max.

MECHANICAL & ELECTRICAL LIFE: 40,000 make-and-break cycles at full load.

CONTACT RESISTANCE: Below 50 mΩ typ. initial @ 2-4 V DC, 100 mA.

INSULATION RESISTANCE: 10<sup>9</sup>Ω min.

DIELECTRIC STRENGTH: 500 Vrms min. @ sea level.

OPERATING TEMPERATURE: -30°C to 85°C.

SOLDERABILITY: Per MIL-STD-202F method 208D, or EIA RS-186E method 9 (1 hour steam aging).

DEGREE OF PROTECTION: IP57; Protection against harmful dust deposit, full-scale voltage protection, temporary immersion.

PACKAGING: Surface mount switches standard in anti-static tape and reel packaging per EIA 481-3, see page A-78 for drawings and reel information.

All models are RoHS compliant and compliant.

## Materials

HOUSING & BASE: Glass filled nylon 4/6, flame retardant, heat stabilized (UL 94V-0).

ACTUATOR: Glass filled nylon 4/6, flame retardant (UL 94V-0) with standard internal o-ring seal.

SWITCH SUPPORT: Brass, tin plated.

MOVABLE CONTACT: Copper alloy, with gold plate over nickel plate.

STATIONARY CONTACTS Copper alloy, with gold plate over nickel plate.

TERMINALS: Copper alloy, with gold flash over nickel plate.

TERMINAL SEAL: Epoxy/Urethane. All terminals insert molded.

**NOTE:** Any models supplied with B contact material are RoHS compliant and compatible. For the latest information regarding RoHS compliance, please go to: [www.ittcannon.com/rohs](http://www.ittcannon.com/rohs).

**NOTE:** Materials listed above are general specifications. Specifications available for specific and custom switches, consult Customer Service Center.

**CAUTION:** PC mounting layouts and pads as shown are designed to be compatible with the latest equipment and reflow techniques. Care should be taken in the design and location of PC lands to suit individual needs. Orientation relative to reflow direction may significantly impact solder joint integrity.

## How To Order

Complete part numbers for GP Series Sealed Ultraminiature Pushbutton Switches are shown on pages A-76 thru A-78.

PART NUMBER	SWITCH FUNCTION		SCHEMATIC
	POS. 1	POS. 2	
<b>GP11MCBE</b>	OFF	MOM.	
Conn. Terms.	OPEN	1-3	SPST
<b>GP12MCBE</b>	ON	MOM.	
Conn. Terms.	2-1	2-3	SPDT

MOM. = Momentary

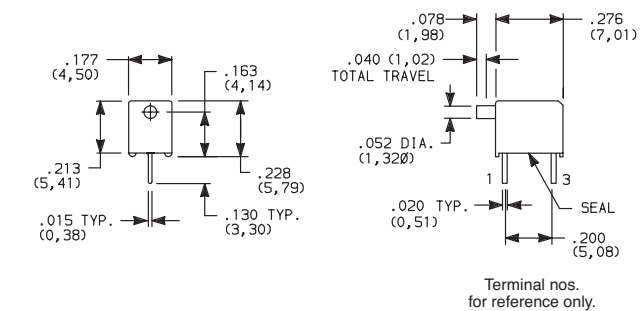

GP11MCBE  
SPST

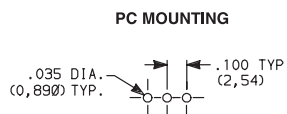

GP11—omit center hole.

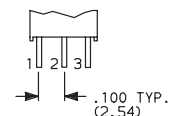

GP12 Model



Dimensions are shown: Inches (mm)  
Specifications and dimensions subject to change



# C&K GP Series Sealed Ultraminiature Pushbutton Switches

A

Pushbutton



GP11MABE  
SPST

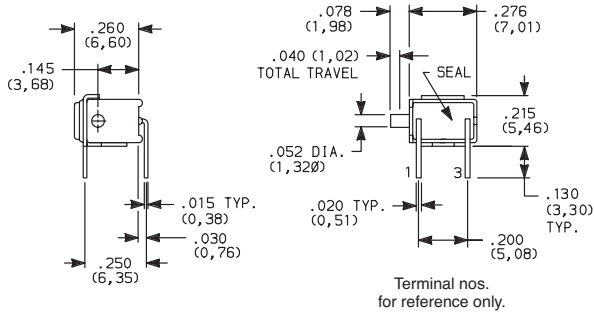

PC MOUNTING

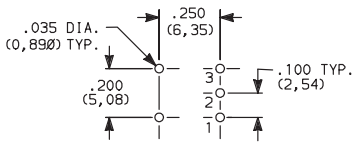

GP11- omit hole 2.

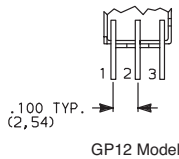

GP12 Model

PART NUMBER	SWITCH FUNCTION		SCHEMATIC
	POS.1	POS. 2	
<b>GP11MABE</b>	OFF	MOM.	 SPST
Conn. Terms.	OPEN	1-3	
<b>GP12MABE</b>	ON	MOM.	 SPDT
Conn. Terms.	2-1	2-3	

MOM. = Momentary

SMT



GP11MSABE  
SPST

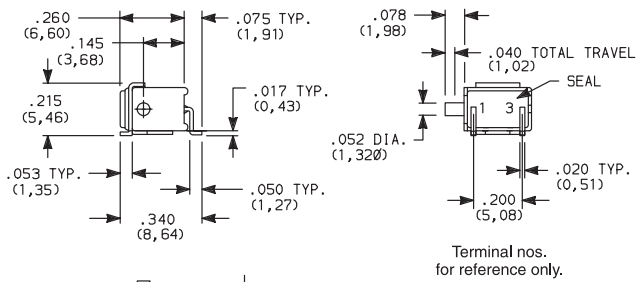

PC MOUNTING

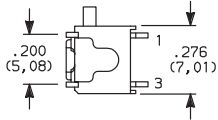

GP12 Model

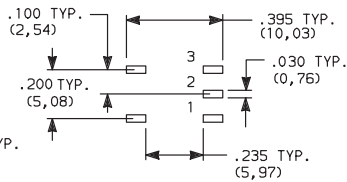

GP11- omit pad 2.

PART NUMBER	SWITCH FUNCTION		SCHEMATIC
	POS.1	POS. 2	
<b>GP11MSABE</b>	OFF	MOM.	 SPST
Conn. Terms.	OPEN	1-3	
<b>GP12MSABE</b>	ON	MOM.	 SPDT
Conn. Terms.	2-1	2-3	

MOM. = Momentary

SMT



GP11MSA1BE  
SPST

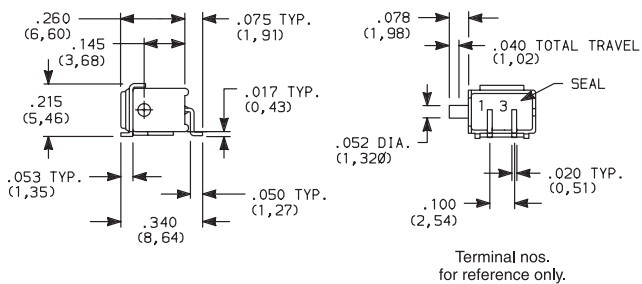

PC MOUNTING

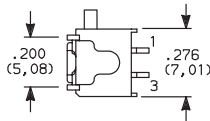

GP12 Model

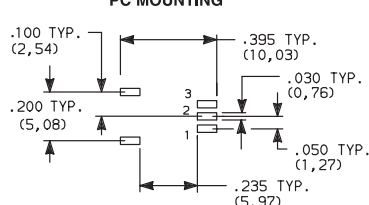

GP11- omit pad 2.

PART NUMBER	SWITCH FUNCTION		SCHEMATIC
	POS.1	POS. 2	
<b>GP11MSA1BE</b>	OFF	MOM.	 SPST
Conn. Terms.	OPEN	1-3	
<b>GP12MSA1BE</b>	ON	MOM.	 SPDT
Conn. Terms.	2-1	2-3	

MOM. = Momentary



Third Angle Projection  
Dimensions are shown: Inches (mm)  
Specifications and dimensions subject to change

# C&K GP Series Sealed Ultraminiature Pushbutton Switches

PART NUMBER	SWITCH FUNCTION		SCHEMATIC
	POS. 1	POS. 2	
<b>GP12MSCBE</b>	ON	MOM.	 NC 1   2 (COMM)   3 NO
Conn. Terms.	2-1	2-3	

MOM. = Momentary

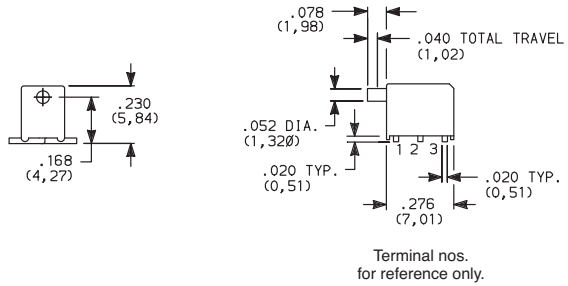

SMT



### PC MOUNTING

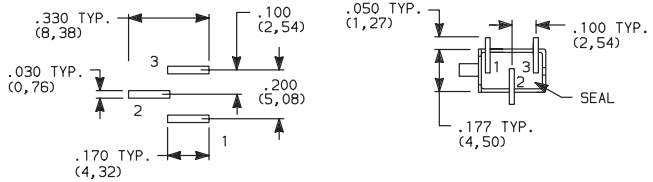

**NOTE:** Recommended for infrequent use applications only  
For increased switch mounting strength, order, SV1 termination style with support bracket (see below).

PART NUMBER	SWITCH FUNCTION		SCHEMATIC
	POS. 1	POS. 2	
<b>GP11MSV1BE</b>	OFF	MOM.	 1   3
Conn. Terms.	OPEN	1-3	
<b>GP12MSV1BE</b>	ON	MOM.	 NC 1   2 (COMM)   3 NO
Conn. Terms.	2-1	2-3	

MOM. = Momentary

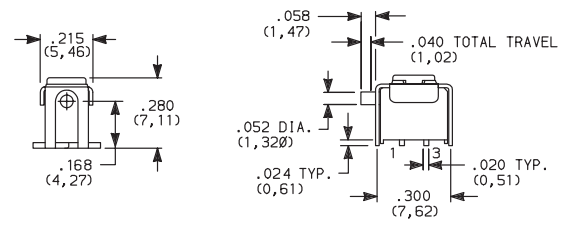

SMT



### PC MOUNTING GP11 MODELS

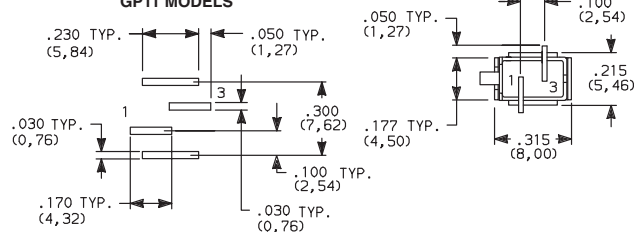

### PC MOUNTING GP12 Models

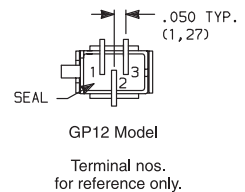
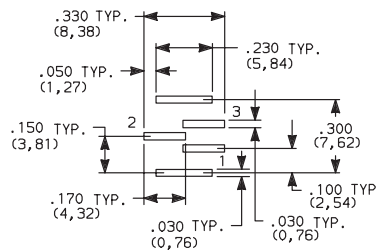

Dimensions are shown: Inches (mm)  
Specifications and dimensions subject to change



# C&K GP Series Sealed Ultraminiature Pushbutton Switches

## TAPE & REEL

A

Pushbutton

For part numbers GP11MSV1BE, GP12MSV1BE

REEL INFORMATION	
OUTSIDE DIAMETER	13.00 (330,0)
PILOT HOLE	.512 (13,0)
QUANTITY PER REEL	600

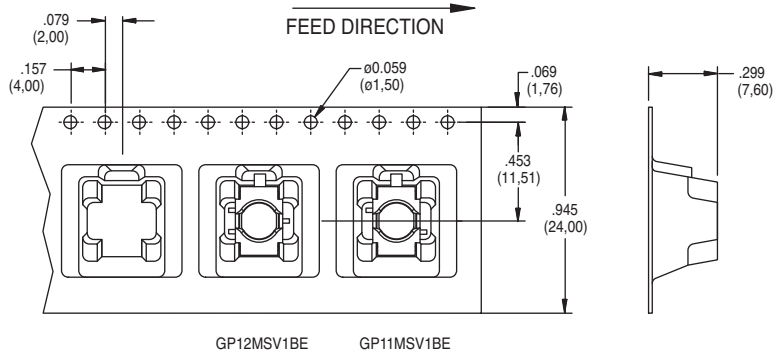

For part numbers GPXXSA1BE, GPXXMCBE, GPXXMSABE

REEL INFORMATION	
OUTSIDE DIAMETER	13.00 (330,0)
PILOT HOLE	.512 (13,0)
QUANTITY PER REEL	600

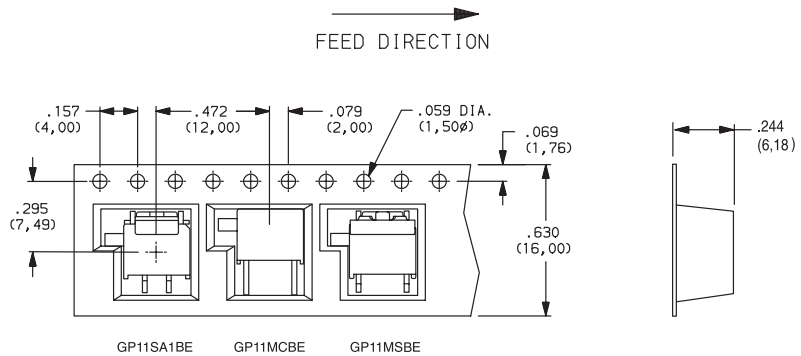

For part numbers GP12MSCBE

REEL INFORMATION	
OUTSIDE DIAMETER	13.00 (330,0)
PILOT HOLE	.512 (13,0)
QUANTITY PER REEL	600

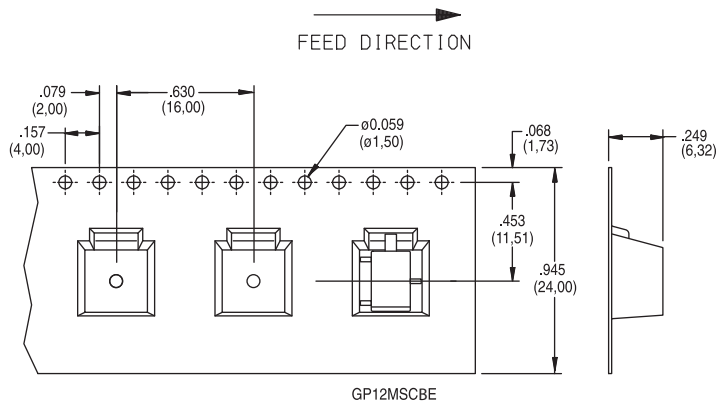

Dimensions are shown: Inches (mm)  
Specifications and dimensions subject to change