

GSC6618

N-CHANNEL ENHANCEMENT MODE POWER MOSFET

| | |
|---------|------|
| BVDSS | 30V |
| RDS(ON) | 30mΩ |
| ID | 7A |

Description

The GSC6618 provide the designer with the best combination of fast switching, ruggedized device design, low on-resistance and cost-effectiveness.

The SOP-8 package is universally preferred for all commercial-industrial surface mount applications and suited for low voltage applications such as DC/DC converters.

Features

- *Simple Drive Requirement
- *Low Gate Charge
- *Fast Switching Characteristic

Package Dimensions

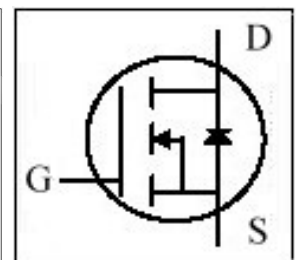
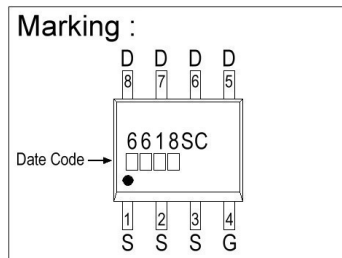
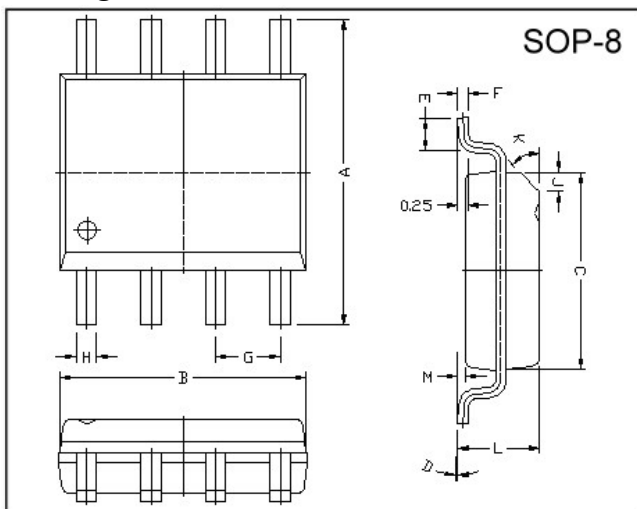

| REF. | Millimeter | | REF. | Millimeter | |
|------|------------|------|------|------------|------|
| | Min. | Max. | | Min. | Max. |
| A | 5.80 | 6.20 | M | 0.10 | 0.25 |
| B | 4.80 | 5.00 | H | 0.35 | 0.49 |
| C | 3.80 | 4.00 | L | 1.35 | 1.75 |
| D | 0° | 8° | J | 0.375 REF. | |
| E | 0.40 | 0.90 | K | 45° | |
| F | 0.19 | 0.25 | G | 1.27 TYP. | |

Absolute Maximum Ratings

| Parameter | Symbol | Ratings | Unit |
|--|-----------------------|------------|------|
| Drain-Source Voltage | V_{DS} | 30 | V |
| Gate-Source Voltage | V_{GS} | ±20 | V |
| Continuous Drain Current ³ | $I_D @TA=25^{\circ}C$ | 7 | A |
| Continuous Drain Current ³ | $I_D @TA=70^{\circ}C$ | 5.8 | A |
| Pulsed Drain Current ¹ | I_{DM} | 30 | A |
| Total Power Dissipation | $P_D @TA=25^{\circ}C$ | 2.5 | W |
| Linear Derating Factor | | 0.02 | W/°C |
| Operating Junction and Storage Temperature Range | T_j, T_{stg} | -55 ~ +150 | °C |

Thermal Data

| Parameter | Symbol | Value | Unit |
|---|---------------|-------|------|
| Thermal Resistance Junction-ambient ³ Max. | $R_{thj-amb}$ | 50 | °C/W |

Electrical Characteristics (T_j = 25°C unless otherwise specified)

| Parameter | Symbol | Min. | Typ. | Max. | Unit | Test Conditions |
|--|--------------------------------|------|------|------|------|---|
| Drain-Source Breakdown Voltage | BV _{DSS} | 30 | - | - | V | V _{GS} =0, I _D =250uA |
| Breakdown Voltage Temperature Coefficient | $\Delta BV_{DSS} / \Delta T_j$ | - | 0.02 | - | V/°C | Reference to 25°C, I _D =1mA |
| Gate Threshold Voltage | V _{GS(th)} | 1.0 | - | 3.0 | V | V _{DS} =V _{GS} , I _D =250uA |
| Forward Transconductance | g _{fs} | - | 13 | - | S | V _{DS} =10V, I _D =7A |
| Gate-Source Leakage Current | I _{GSS} | - | - | ±100 | nA | V _{GS} = ±20V |
| Drain-Source Leakage Current(T _j =25°C) | I _{DSS} | - | - | 1 | uA | V _{DS} =30V, V _{GS} =0 |
| Drain-Source Leakage Current(T _j =70°C) | | - | - | 25 | uA | V _{DS} =24V, V _{GS} =0 |
| Static Drain-Source On-Resistance ² | R _{DS(ON)} | - | - | 30 | mΩ | V _{GS} =10V, I _D =7A |
| | | - | - | 50 | | V _{GS} =4.5V, I _D =5A |
| Total Gate Charge ² | Q _g | - | 8.4 | 13 | nC | I _D =7A V _{DS} =24V V _{GS} =4.5V |
| Gate-Source Charge | Q _{gs} | - | 2.1 | - | | |
| Gate-Drain ("Miller") Charge | Q _{gd} | - | 4.7 | - | | |
| Turn-on Delay Time ² | T _{d(on)} | - | 6 | - | ns | V _{DS} =15V I _D =1A V _{GS} =10V R _G =3.3Ω R _D =15Ω |
| Rise Time | T _r | - | 5.2 | - | | |
| Turn-off Delay Time | T _{d(off)} | - | 18.8 | - | | |
| Fall Time | T _f | - | 4.4 | - | | |
| Input Capacitance | C _{iss} | - | 645 | 800 | pF | V _{GS} =0V V _{DS} =25V f=1.0MHz |
| Output Capacitance | C _{oss} | - | 150 | - | | |
| Reverse Transfer Capacitance | C _{rss} | - | 95 | - | | |

Source-Drain Diode

| Parameter | Symbol | Min. | Typ. | Max. | Unit | Test Conditions |
|------------------------------------|-----------------|------|------|------|------|--|
| Forward On Voltage ² | V _{SD} | - | - | 1.2 | V | I _S =2A, V _{GS} =0V |
| Reverse Recovery Time ² | T _{rr} | - | 16 | - | ns | I _S =7A, V _{GS} =0V dI/dt=100A/μs |
| Reverse Recovery Charge | Q _{rr} | - | 10 | - | nC | |

Notes: 1. Pulse width limited by Max. junction temperature.

2. Pulse width ≤ 300us, duty cycle ≤ 2%.

3. Surface mounted on 1 in² copper pad of FR4 board; 125°C/W when mounted on Min. copper pad.

Characteristics Curve

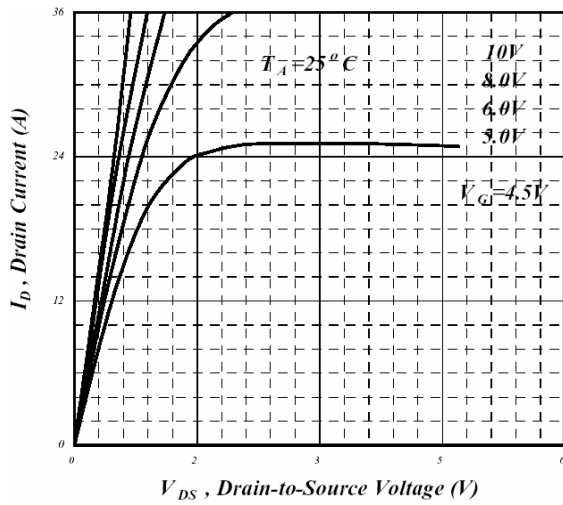

Fig 1. Typical Output Characteristics

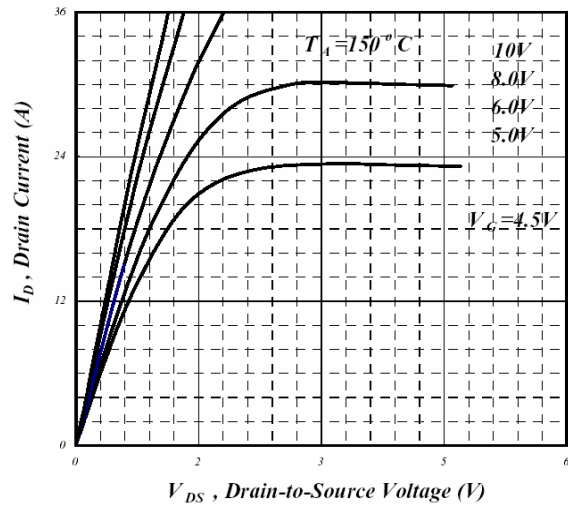

Fig 2. Typical Output Characteristics

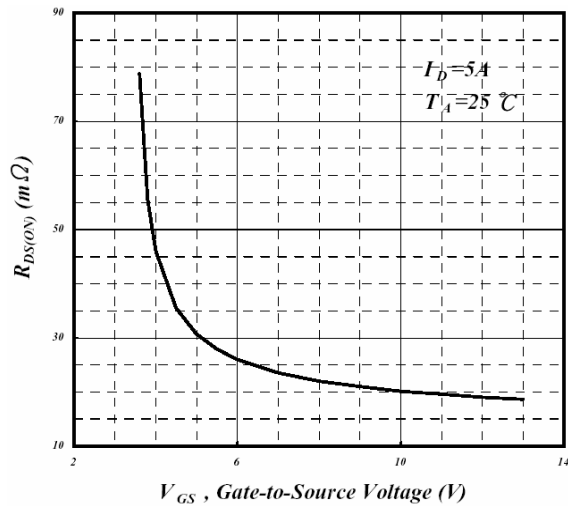

Fig 3. On-Resistance v.s. Gate Voltage

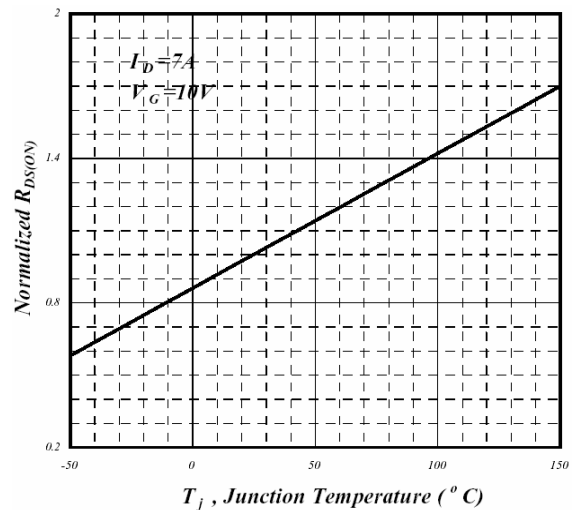

Fig 4. Normalized On-Resistance v.s. Junction Temperature

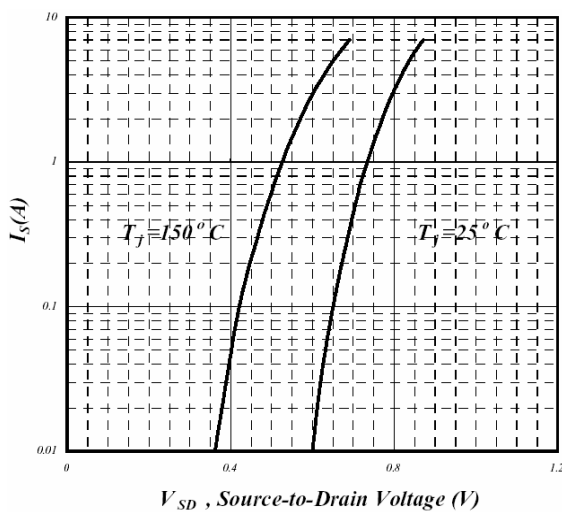

Fig 5. Forward Characteristics of Reverse Diode

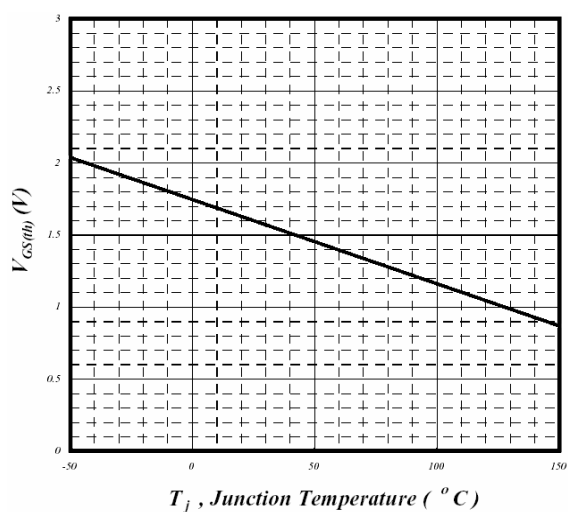

Fig 6. Gate Threshold Voltage v.s. Junction Temperature

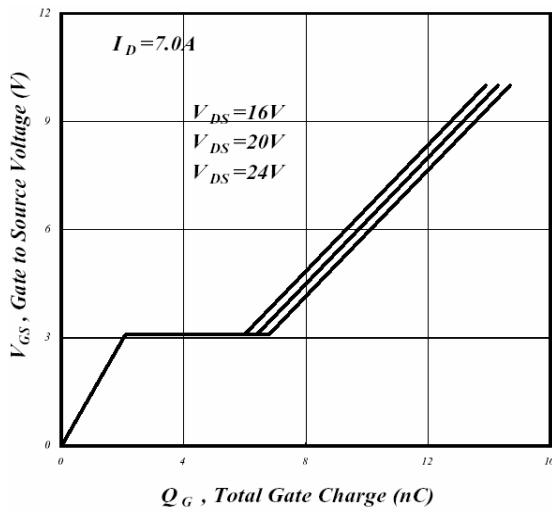

Fig 7. Gate Charge Characteristics

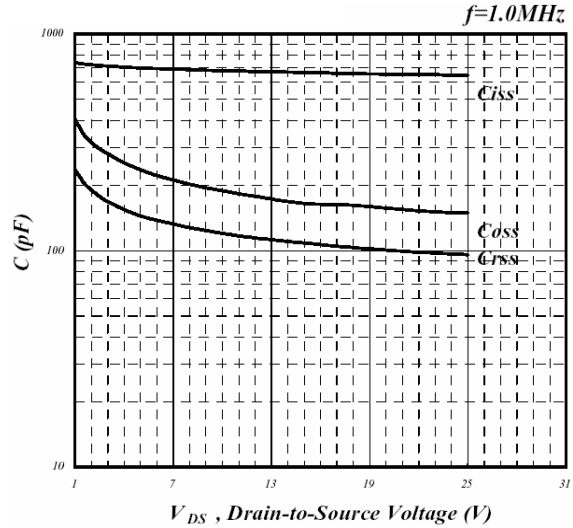

Fig 8. Typical Capacitance Characteristics

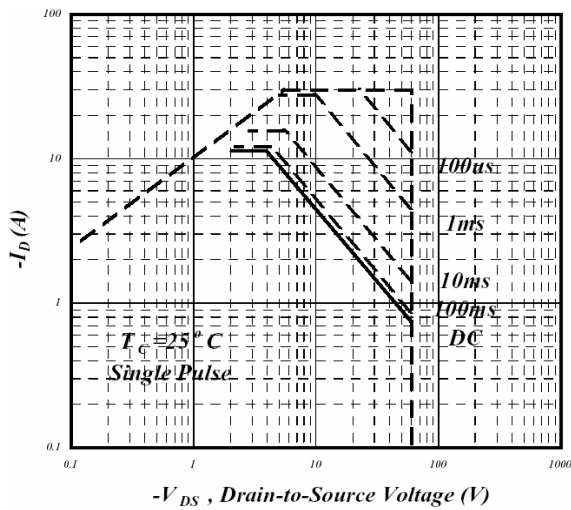

Fig 9. Maximum Safe Operating Area

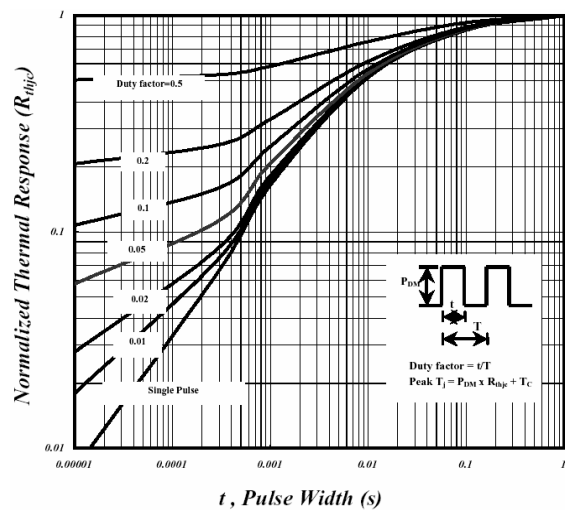

Fig 10. Effective Transient Thermal Impedance

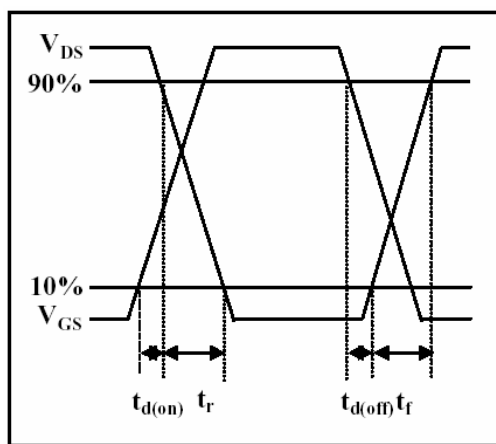

Fig 11. Switching Time Waveform

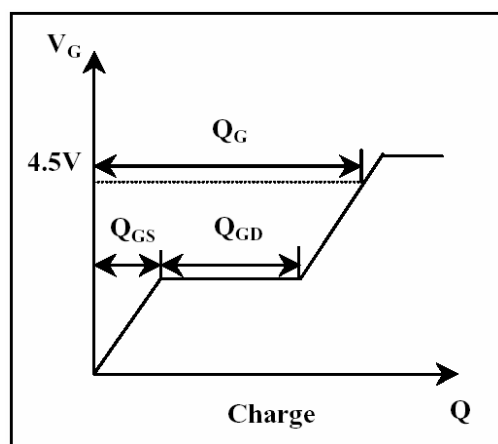

Fig 12. Gate Charge Waveform

Important Notice:
 All rights are reserved. Reproduction in whole or in part is prohibited without the prior written approval of GTM.
 • GTM reserves the right to make changes to its products without notice.
 • GTM semiconductor products are not warranted to be suitable for use in life-support Applications, or systems.
 • GTM assumes no liability for any consequence of customer product design, infringement of patents, or application assistance.
Head Office And Factory:
 • **Taiwan:** No. 17-1 Tatung Rd. Fu Kou Hsin-Chu Industrial Park, Hsin-Chu, Taiwan, R. O. C.
 TEL : 886-3-597-7061 FAX : 886-3-597-9220, 597-0785
 • **China:** (201203) No.255, Jang-Jiang Tsai-Lueng RD. , Pu-Dung-Hsin District, Shang-Hai City, China
 TEL : 86-21-5895-7671 ~ 4 FAX : 86-21-38950165