

**PNP Silicon Digital Transistor**

- Switching circuit, inverter, interface circuit, driver circuit
- Built in bias resistor ( $R_1=2.2k\Omega$ ,  $R_2=10k\Omega$ )

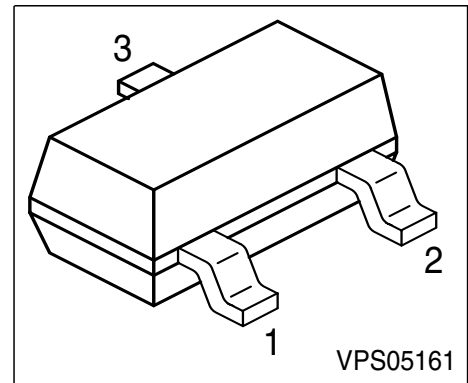
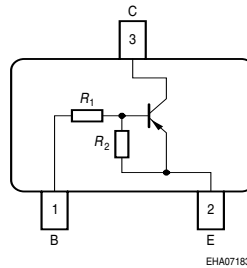

Type	Marking	Pin Configuration			Package
BCR 555	XD5	1 = B	2 = E	3 = C	SOT-23

**Maximum Ratings**

Parameter	Symbol	Value	Unit
Collector-emitter voltage	$V_{CEO}$	50	V
Collector-base voltage	$V_{CBO}$	50	
Emitter-base voltage	$V_{EBO}$	5	
Input on Voltage	$V_{i(on)}$	12	
DC collector current	$I_C$	500	mA
Total power dissipation, $T_S = 79\text{ }^\circ\text{C}$	$P_{tot}$	330	mW
Junction temperature	$T_j$	150	$^\circ\text{C}$
Storage temperature	$T_{stg}$	-65 ... 150	

**Thermal Resistance**

Junction ambient <sup>1)</sup>	$R_{thJA}$	$\leq 325$	K/W
Junction - soldering point	$R_{thJS}$	$\leq 215$	

1) Package mounted on pcb 40mm x 40mm x 1.5mm / 6cm<sup>2</sup>Cu

**Electrical Characteristics at  $T_A=25^\circ\text{C}$ , unless otherwise specified**

Parameter	Symbol	Values			Unit
		min.	typ.	max.	
<b>DC Characteristics</b>					
Collector-emitter breakdown voltage $I_C = 100 \mu\text{A}, I_B = 0$	$V_{(BR)CEO}$	50	-	-	V
Collector-base breakdown voltage $I_C = 10 \mu\text{A}, I_B = 0$	$V_{(BR)CBO}$	50	-	-	
Collector cutoff current $V_{CB} = 40 \text{ V}, I_E = 0$	$I_{CBO}$	-	-	100	nA
Emitter cutoff current $V_{EB} = 5 \text{ V}, I_C = 0$	$I_{EBO}$	-	-	0.65	mA
DC current gain 1) $I_C = 50 \text{ mA}, V_{CE} = 5 \text{ V}$	$h_{FE}$	70	-	-	-
Collector-emitter saturation voltage1) $I_C = 50 \text{ mA}, I_B = 2.5 \text{ mA}$	$V_{CEsat}$	-	-	0.3	V
Input off voltage $I_C = 100 \mu\text{A}, V_{CE} = 5 \text{ V}$	$V_{i(off)}$	0.4	-	1	V
Input on Voltage $I_C = 10 \text{ mA}, V_{CE} = 0.3 \text{ V}$	$V_{i(on)}$	0.5	-	1.4	
Input resistor	$R_1$	1.5	2.2	2.9	k $\Omega$
Resistor ratio	$R_1/R_2$	0.19	0.22	0.24	-
<b>AC Characteristics</b>					
Transition frequency $I_C = 50 \text{ mA}, V_{CE} = 5 \text{ V}, f = 100 \text{ MHz}$	$f_T$	-	150	-	MHz

 1) Pulse test:  $t < 300\mu\text{s}$ ;  $D < 2\%$

**DC Current Gain  $h_{FE} = f(I_C)$**

$V_{CE} = 5V$  (common emitter configuration)

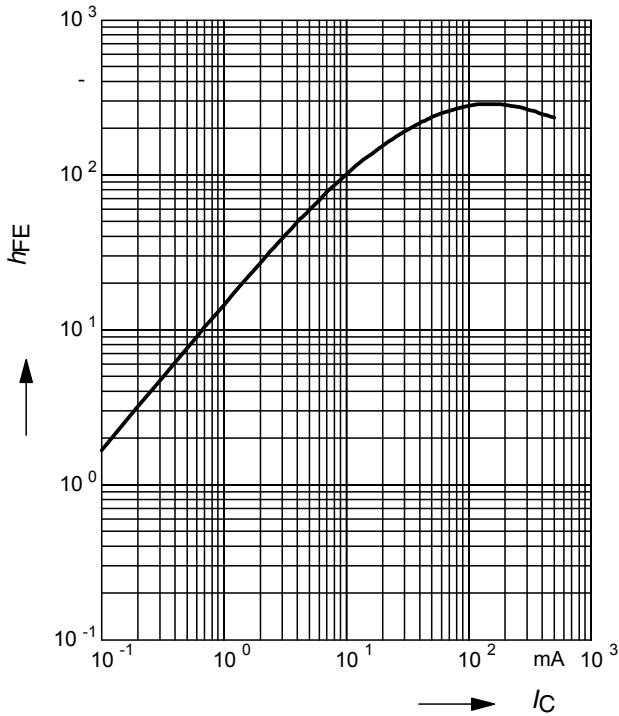

**Collector-Emitter Saturation Voltage**

$V_{CEsat} = f(I_C), h_{FE} = 20$

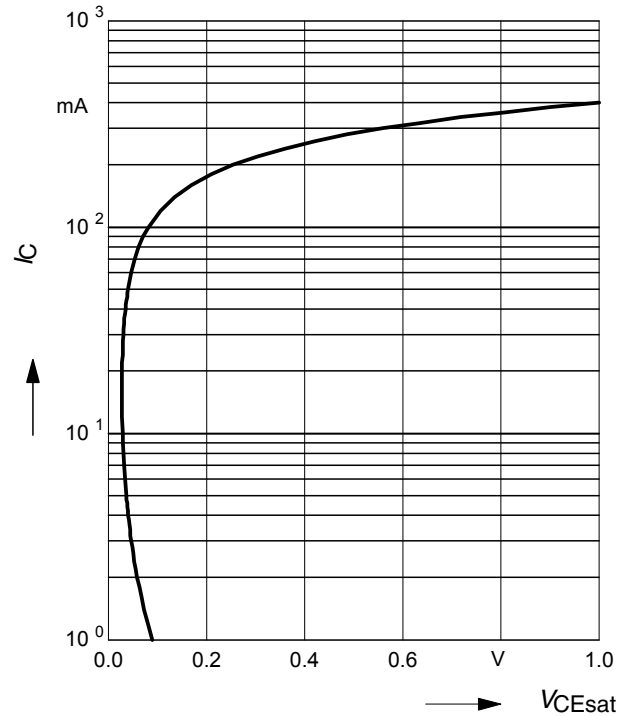

**Input on Voltage  $V_{i(on)} = f(I_C)$**

$V_{CE} = 0.3V$  (common emitter configuration)

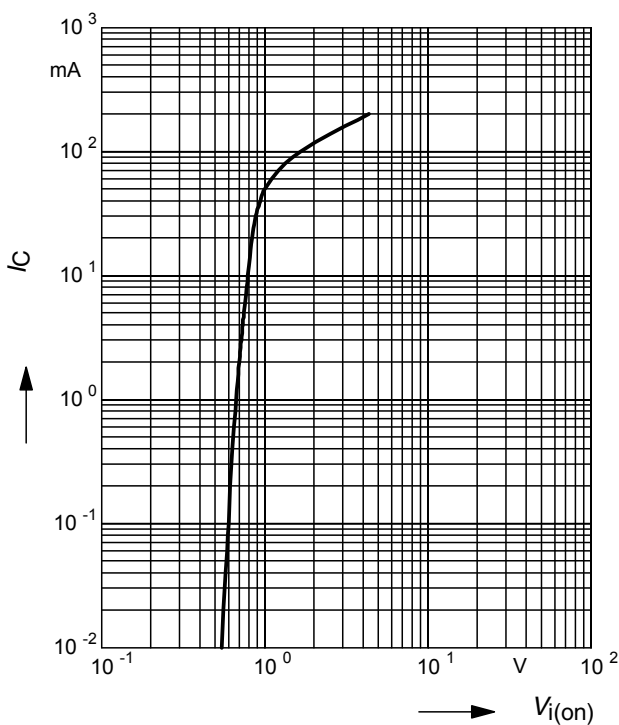

**Input off voltage  $V_{i(off)} = f(I_C)$**

$V_{CE} = 5V$  (common emitter configuration)

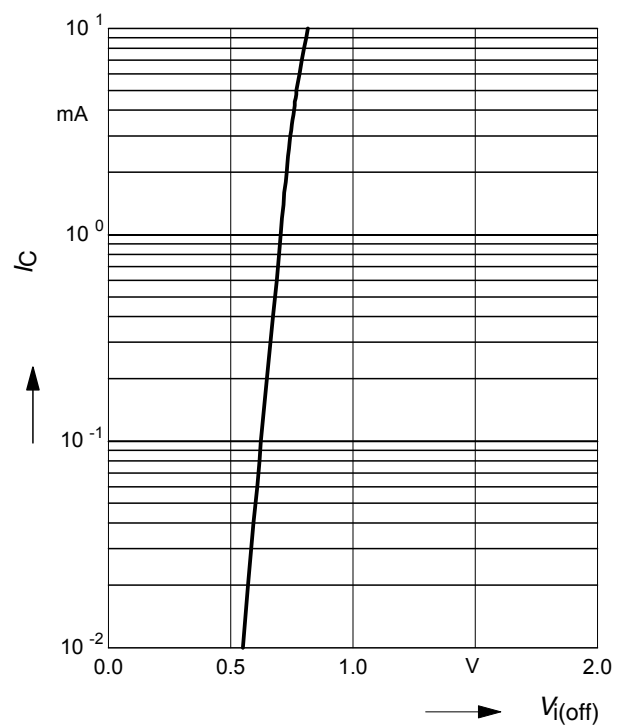

**Total power dissipation  $P_{tot} = f(T_A^*; T_S)$**

\* Package mounted on epoxy

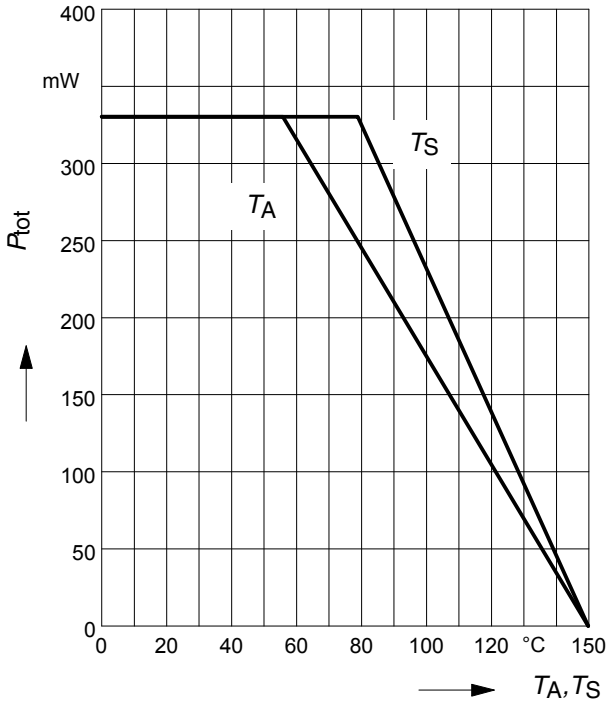

**Permissible Pulse Load  $R_{thJS} = f(t_p)$**

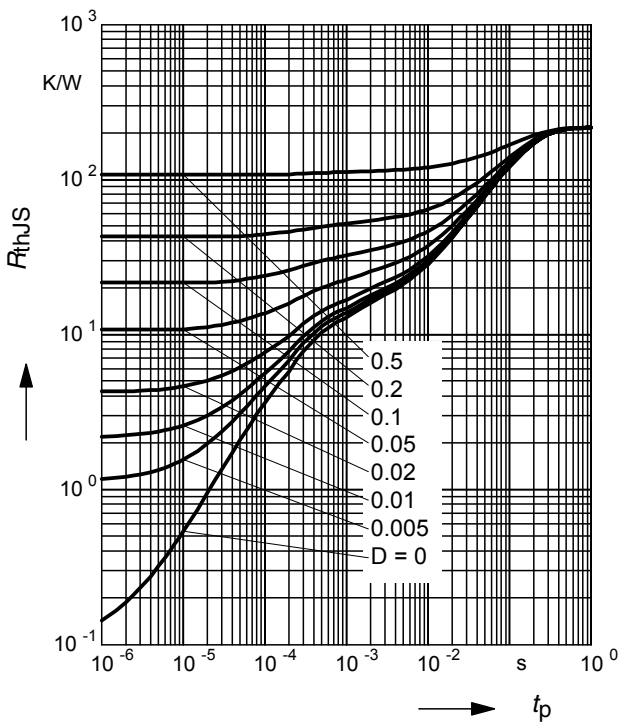

**Permissible Pulse Load**

$P_{totmax} / P_{totDC} = f(t_p)$

