

# SMD Inductors(Coils) For Power Line(Wound, Magnetic Shielded)

Conformity to RoHS Directive

## VLF-MT Series VLF302512MT

With the VLF302512MT Series, a DC to DC converter with top-class voltage conversion efficiency for similar size products was achieved by optimizing the magnetic material and configuration. These products are optimal for use as choke coils in switching power supplies such as those in mobile devices requiring space-saving design.

### FEATURES

- Miniature size  
Mount area: 3.0×2.5mm  
Low profile: 1.2mm max. height
- Generic use for portable DC to DC converter line.
- High magnetic shield construction should actualize high resolution for EMC protection.
- The products contain no lead and also support lead-free soldering.
- The products is halogen-free.
- It is a product conforming to RoHS directive.

### APPLICATIONS

Smartphones, cellular phones, DSCs, DVCs, HDDs, LCD displays, compact power supply modules, etc.

### SHAPES AND DIMENSIONS

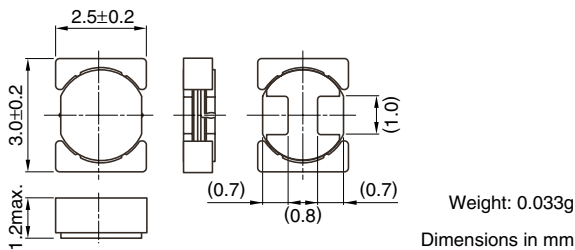

### RECOMMENDED PC BOARD PATTERN

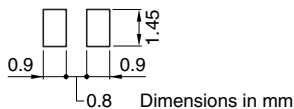

### CIRCUIT DIAGRAM

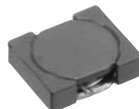

### PRODUCT IDENTIFICATION

|     |         |     |     |     |   |
|-----|---------|-----|-----|-----|---|
| VLF | 302512M | T   | -   | 1R0 | N |
| (1) | (2)     | (3) | (4) | (5) |   |

- (1) Series name
- (2) Dimensions L×W×H mm max.
- (3) Packaging style

|   |                                   |
|---|-----------------------------------|
| T | Taping<br>(Embossed carrier tape) |
|---|-----------------------------------|

- (4) Inductance value

|     |       |
|-----|-------|
| 1R0 | 1.0μH |
| 100 | 10μH  |

- (5) Inductance tolerance

|   |      |
|---|------|
| M | ±20% |
| N | ±30% |

### PACKAGING STYLE AND QUANTITIES

|                 |                  |
|-----------------|------------------|
| Packaging style | Quantity         |
| Taping          | 2000 pieces/reel |

### HANDLING AND PRECAUTIONS

- Before soldering, be sure to preheat components.  
The preheating temperature should be set so that the temperature difference between the solder temperature and product temperature does not exceed 150°C.
- When hand soldering, apply the soldering iron to the printed circuit board only. Temperature of the iron tip should not exceed 350°C. Soldering time should not exceed 3 seconds.

### RECOMMENDED SOLDERING CONDITION REFLOW SOLDERING

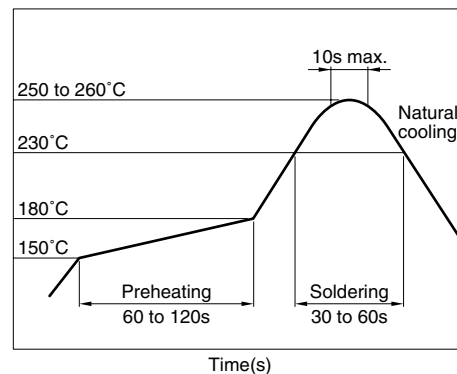

• Conformity to RoHS Directive: This means that, in conformity with EU Directive 2002/95/EC, lead, cadmium, mercury, hexavalent chromium, and specific bromine-based flame retardants, PBB and PBDE, have not been used, except for exempted applications.

• Please contact our Sales office when your application are considered the following:  
The device's failure or malfunction may directly endanger human life (e.g. application for automobile/aircraft/medical/nuclear power devices, etc.)

• All specifications are subject to change without notice.

## ELECTRICAL CHARACTERISTICS

| Part No.         | Inductance<br>( $\mu\text{H}$ ) | Inductance<br>tolerance(%) | Test frequency<br>(MHz) | DC resistance( $\Omega$ ) |       | Rated current*(A)                  |      |                                   |
|------------------|---------------------------------|----------------------------|-------------------------|---------------------------|-------|------------------------------------|------|-----------------------------------|
|                  |                                 |                            |                         | max.                      | typ.  | Based on inductance<br>change Idc1 |      | Based on temperature<br>rise Idc2 |
|                  |                                 |                            |                         |                           |       | max.                               | typ. | typ.                              |
| VLF302512MT-1R0N | 1.0                             | $\pm 30$                   | 1.0                     | 0.037                     | 0.031 | 1.91                               | 2.12 | 2.77                              |
| VLF302512MT-1R5N | 1.5                             | $\pm 30$                   | 1.0                     | 0.044                     | 0.037 | 1.67                               | 1.85 | 2.54                              |
| VLF302512MT-2R2M | 2.2                             | $\pm 20$                   | 1.0                     | 0.066                     | 0.055 | 1.26                               | 1.40 | 1.95                              |
| VLF302512MT-3R3M | 3.3                             | $\pm 20$                   | 1.0                     | 0.108                     | 0.090 | 1.08                               | 1.20 | 1.63                              |
| VLF302512MT-4R7M | 4.7                             | $\pm 20$                   | 1.0                     | 0.136                     | 0.113 | 0.97                               | 1.08 | 1.42                              |
| VLF302512MT-6R8M | 6.8                             | $\pm 20$                   | 1.0                     | 0.194                     | 0.162 | 0.78                               | 0.84 | 1.21                              |
| VLF302512MT-100M | 10                              | $\pm 20$                   | 1.0                     | 0.299                     | 0.249 | 0.62                               | 0.69 | 0.95                              |
| VLF302512MT-150M | 15                              | $\pm 20$                   | 1.0                     | 0.448                     | 0.373 | 0.51                               | 0.57 | 0.80                              |
| VLF302512MT-220M | 22                              | $\pm 20$                   | 1.0                     | 0.700                     | 0.583 | 0.43                               | 0.47 | 0.64                              |

\* Rated current: Value obtained when current flows and the temperature has risen to 40°C or when DC current flows and the nominal value of inductance has fallen by 30%, whichever is smaller.

- Operating temperature range: -40 to +105°C (Including self-temperature rise)

## TYPICAL ELECTRICAL CHARACTERISTICS

### INDUCTANCE vs. DC SUPERPOSITION CHARACTERISTICS

#### VLF302512MT-1R0N

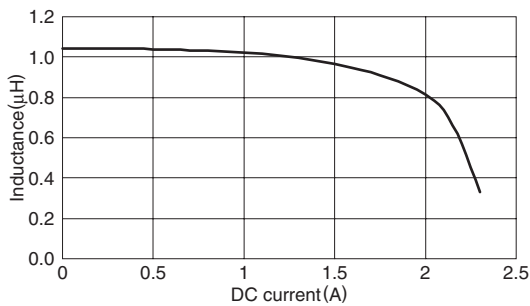

#### VLF302512MT-1R5N

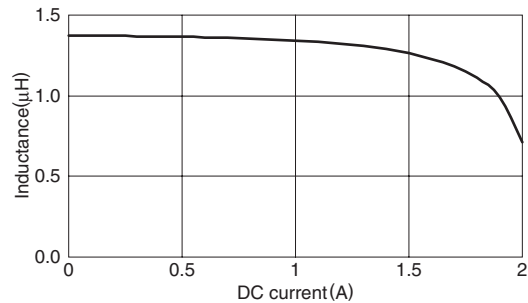

#### VLF302512MT-2R2M

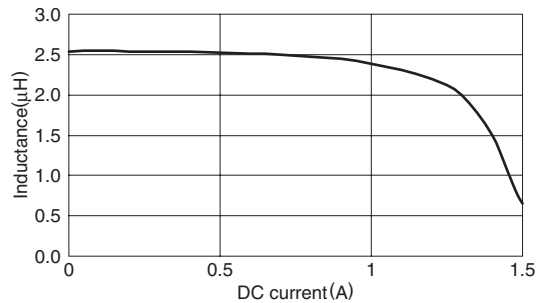

#### VLF302512MT-3R3M

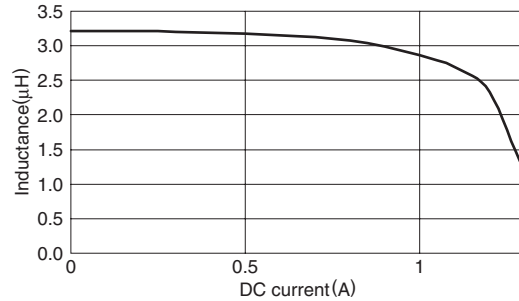

#### VLF302512MT-4R7M

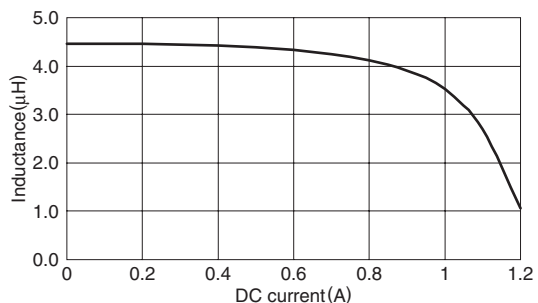

#### VLF302512MT-6R8M

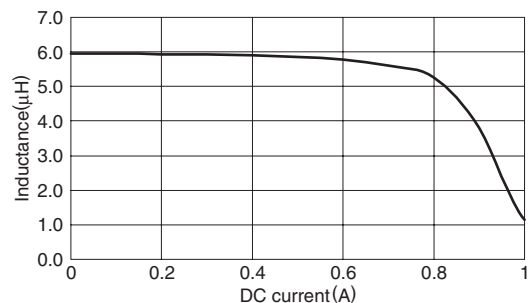

## TYPICAL ELECTRICAL CHARACTERISTICS

### INDUCTANCE vs. DC SUPERPOSITION CHARACTERISTICS

#### VLF302512MT-100M

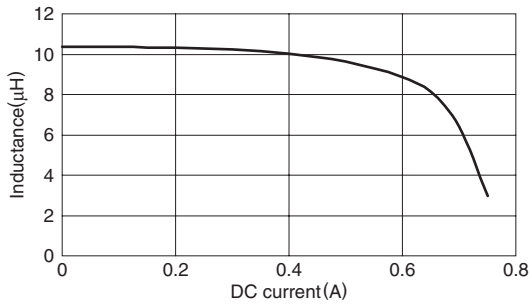

#### VLF302512MT-150M

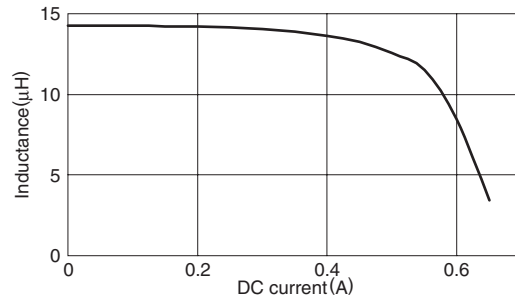

#### VLF302512MT-220M

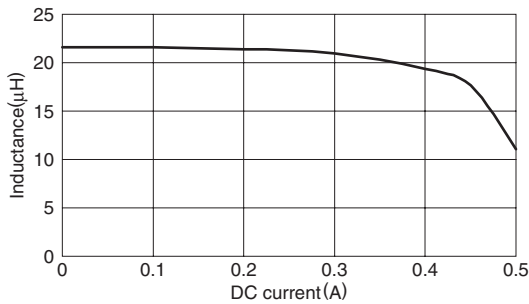

### TEST CIRCUIT

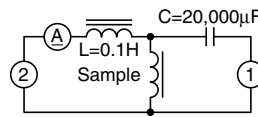

- 1: LCR meter 4285A  $f=1\text{MHz}$   
2: DC constant current source

## PACKAGING STYLES

### REEL DIMENSIONS

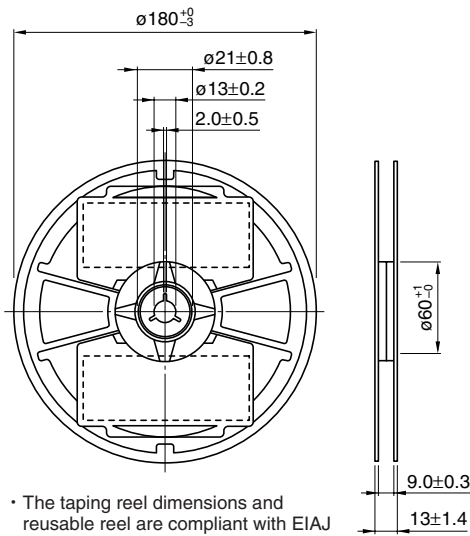

- The taping reel dimensions and reusable reel are compliant with EIAJ ET-7200.

Dimensions in mm

### TAPE DIMENSIONS

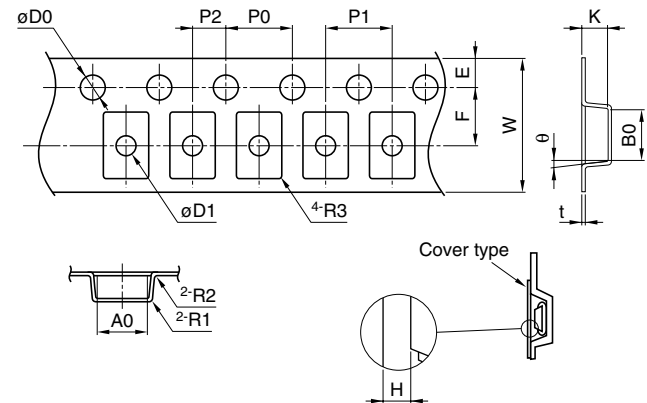

Dimensions in mm

| A0       | B0        | W            | F        | E          |
|----------|-----------|--------------|----------|------------|
| 2.8typ.  | 3.3typ.   | 8.00±0.2     | 3.50±0.1 | 1.75±0.1   |
| P1       | P2        | H            | P0       | ∅D0        |
| 4.00±0.1 | 2.00±0.05 | 0.05 to 0.35 | 4.0±0.1  | 1.5+0.1/-0 |
| K        | ∅D1       | t            | R1 to R3 | θ          |
| 1.35±0.1 | 1.2±0.2   | 0.25±0.05    | 0.3max.  | 5° typ.    |