



Doc. Version	0.1
Total Page	24
Date	2008/07/22

Product Specification

4.3" COLOR TFT-LCD MODULE

MODEL NAME: A043FL01 V5

- < > Preliminary Specification
< > Final Specification

Note: The content of this specification is subject to change.

© 2008 AU Optronics
All Rights Reserved,
Do Not Copy.



Record of Revision

Version	Revise Date	Page	Content
0.0	2007/05/02		First draft.
0.1	2007/05/07	6	Update drawing

AUO Confidential For PROMATE Internal Use Only / 2008/8/14

Contents:

<u>A. General Description</u>	4
<u>B. Features</u>	4
<u>C. Physical Specifications</u>	5
<u>D. Outline Dimension (Tentative)</u>	6
<u>E. Electrical Specifications</u>	7
1. Pin Assignment	7
2. Absolute Maximum Ratings.....	8
3. Electrical Characteristics	9
a. TFT- LCD Panel	9
b. Backlight Driving Conditions	9
4. Suggested Application Circuit.....	10
a. Suggested Application Circuit	10
5. AC Timing	11
a. Power on/off sequence.....	11
b. Timing Condition	12
c. Timing Diagram	13
<u>F. Optical specifications (Note 1, 2)</u>	14
<u>G. Touch Screen Panel Specifications</u>	16
<u>1. Electrical Characteristics</u>	16
2. Mechanical Characteristics.....	16
3. Life test Condition.....	16
4. Attention.....	17
<u>H. Reliability Test Items</u>	18
<u>I. Packing Form</u>	19

AUO Confidential For PROMATE Internal Use Only / 2008/8/14

A. General Description

A043FL01 V5 is an LTPS transmissive type Thin Film Transistor Liquid crystal Display (TFT-LCD). This model is composed of a TFT-LCD, a driver, an FPC (flexible printed circuit), a backlight unit and a touch panel.

B. Features

- 4.3-inch display with touch panel
- WQVGA resolution in RGB stripe dot arrangement
- DC/DC integrated
- High brightness
- Interfaces: parallel RGB 24-bit
- Wide viewing angle
- Integrated touch screen panel (resistive type)
- 3-in-1 FPC for LCD signals, backlight LED power and touch panel
- Green design

AUO Confidential For PROMATE Internal Use Only / 2008/8/14

C. Physical Specifications

NO.	Item	Unit	Specification	Remark
1	Display Resolution	dot	480 RGB (H)×272(V)	
2	Active Area	mm	95.04(H)×53.856(V)	
3	Screen Size	inch	4.3(Diagonal)	
4	Dot Pitch	mm	0.066(H)×0.198(V)	
5	Color Configuration	--	R. G. B. Stripe	Note 1
6	Color Depth	--	16.7M Colors	
7	Overall Dimension	mm	105.5(H) × 67.2(V) × 3.9(T)	Note 2
8	Weight	g	56	
9	Touch panel surface treatment	--	Hard coating 3H	
10	Display Mode	--	Normally White	
11	Gray Level Inversion Direction		6 O'clock	

Note 1: Below figure shows dot stripe arrangement.

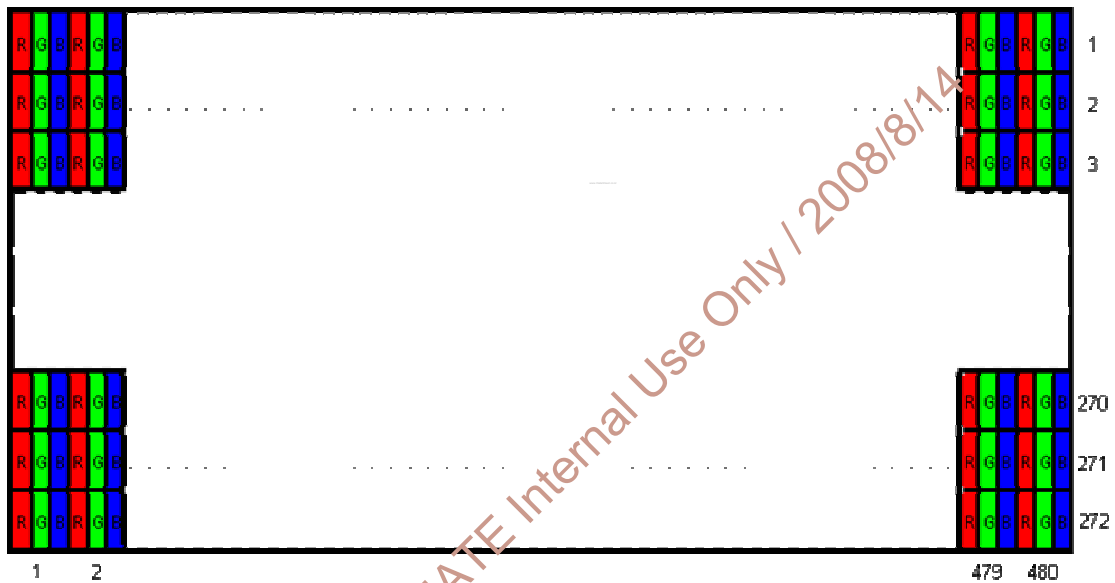

Note 2: Not including FPC. Refer to the drawing next page for further information.

D. Outline Dimension (Tentative)

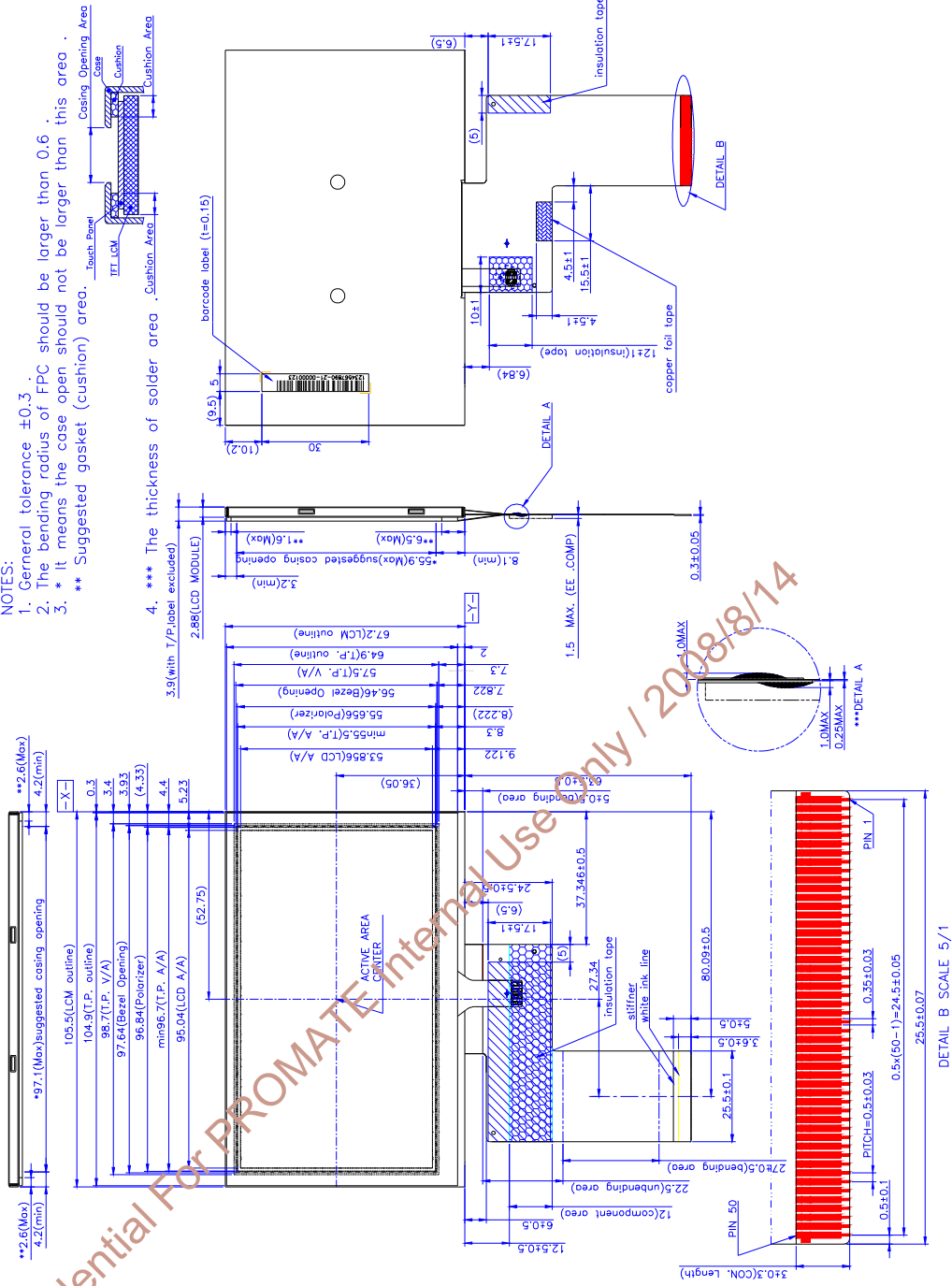

- NOTES:
 1. General tolerance ±0.3
 2. The bending radius of FPC should be larger than 0.6 .
 3. * It means the case open should not be larger than this area .
 ** Suggested gasket (cushion) area.
 4. *** The thickness of solder area .Cushion Area

E. Electrical Specifications

1. Pin Assignment

No.	Pin Name	I/O	Description	Remarks
1	GND	P	Ground	
2	GND	P	Ground	
3	VDD	P	Power supply	
4	VDD	P	Power supply	
5	R0	I	Red data (LSB)	
6	R1	I	Red data	
7	R2	I	Red data	
8	R3	I	Red data	
9	R4	I	Red data	
10	R5	I	Red data	
11	R6	I	Red data	
12	R7	I	Red data (MSB)	
13	G0	I	Green data (LSB)	
14	G1	I	Green data	
15	G2	I	Green data	
16	G3	I	Green data	
17	G4	I	Green data	
18	G5	I	Green data	
19	G6	I	Green data	
20	G7	I	Green data (MSB)	
21	B0	I	Blue data (LSB)	
22	B1	I	Blue data	
23	B2	I	Blue data	
24	B3	I	Blue data	
25	B4	I	Blue data	
26	B5	I	Blue data	
27	B6	I	Blue data	
28	B7	I	Blue data (MSB)	
29	GND	P	Ground	
30	CLK	I	Pixel clock	Note 2
31	DISP	I	DISP : 'L' → Display OFF DISP : 'H' → Display ON	Note 2
32	HSYNC	I	Horizontal Sync Signal	Note 2

33	VSYNC	I	Vertical Sync Signal	Note 2
34	DE	I	Data Enable	Note 2
35	U/D	I	Shift Up or Down Control	
36	NC		None Connect	
37	GND	P	Ground	
38	GND	P	Ground	
39	TP_R	O	Touch Panel Right Signal	
40	TP_B	O	Touch Panel Bottom Signal	
41	TP_L	O	Touch Panel Left Signal	
42	TP_U	O	Touch Panel Up Signal	
43	GND	P	Ground	
44	GND	P	Ground	
45	GND	P	Ground	
46	VLED-	P	LED cathode	
47	VLED+	P	LED anode	
48	GND	P	Ground	
49	GND	P	Ground	
50	GND	P	Ground	

I: Digital signal input, O: Digital signal output, G: GND, PI: Power input, C: Capacitor

2. Absolute Maximum Ratings

Items	Symbol	Values		Unit	Condition
		Min.	Max.		
Power Voltage	V_{DD}	-0.3	4.5	V	
Input Signal Voltage	V_i	$0.8 * V_{DD}$	VDD	V	
	V_l	GND	$0.2 * V_{DD}$	V	
LED Reverse Voltage	V_r	--	3.5	V	One LED
LED Forward Current	I_f	--	25	mA	One LED
Operation Temperature	T_{op}	-20	70	°C	
Storage Temperature	T_{st}	-30	80	°C	

Note 1.If the operating condition exceeds the absolute maximum ratings, the TFT-LCD module may be damaged permanently. Also, if the module operated with the absolute maximum ratings for a long time, its reliability may drop.

3. Electrical Characteristics

The following items are measured under stable condition and suggested application circuit.

a. TFT- LCD Panel

Parameter	Symbol	Min	Typ	Max	Unit	Notes
Power Supply Voltage	V_{DD}	3.0	3.3	3.6	V	
Power Supply Current	I_{VDD}			35	mA	
Frame Frequency	f_{Frame}		60	70	Hz	
Dot Data Clock	DCLK		9.2	TBD	MHz	

Note 1. Panel surface temperature should be kept less than content of section E.2. "Absolute maximum ratings"

b. Backlight Driving Conditions

Parameter	Symbol	Min.	Typ.	Max.	Unit	Remark
LED Supply	I_L		20		mA	single serial
LED Supply	V_L		(22.4)		V	single serial
LED Life Time	L_L	10,000	---	---	Hr	Note 2, 3

Note 1: LED backlight is 7 LEDs serial type.

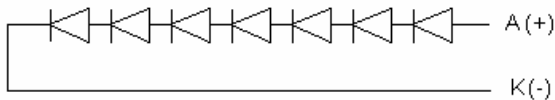

Note 2: The LED lifetime could be decreased if operating I_L is larger than 25mA

4. Suggested Application Circuit

a. Suggested Application Circuit

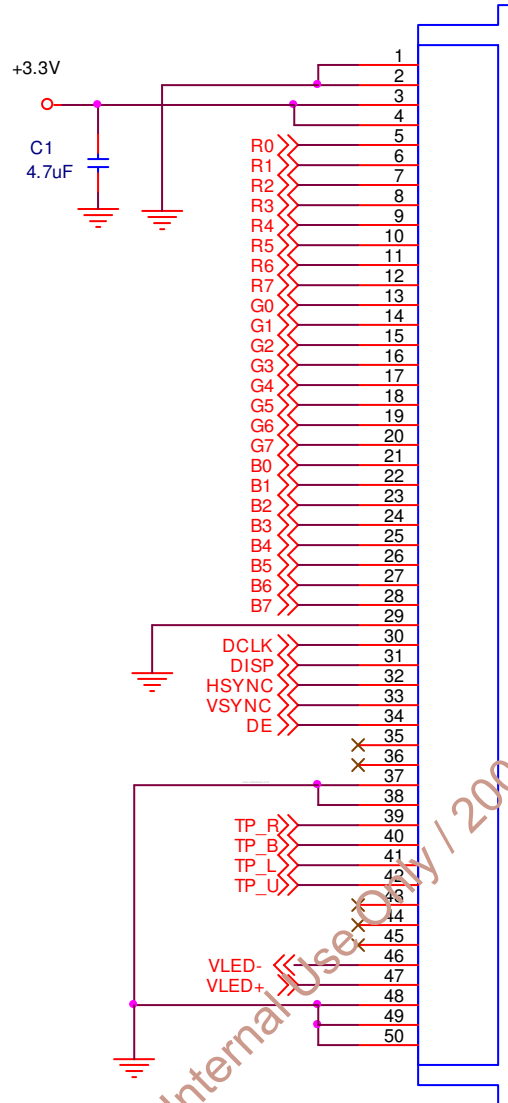

AUO Confidential For PROMATE Internal Use Only / 2008/8/14

5. AC Timing

a. Power on/off sequence

Power On (Display ON; Standby Disabling)

The LCD driver is in default standby mode after VDD/VDDIO power-on, and set the register DISP to high to disable the standby mode is required for normal operation. When the standby mode is disabled, a build-in power on sequence is started. The driver IC analog power VDD2 is turned on first, and then the LCD positive and negative power supplies VGH/VGL are pumped, and followed by the LED power. Since we recommend using external LED driver, the backlight power should be provided at this time. Please refer to power on sequence for the detail timing.

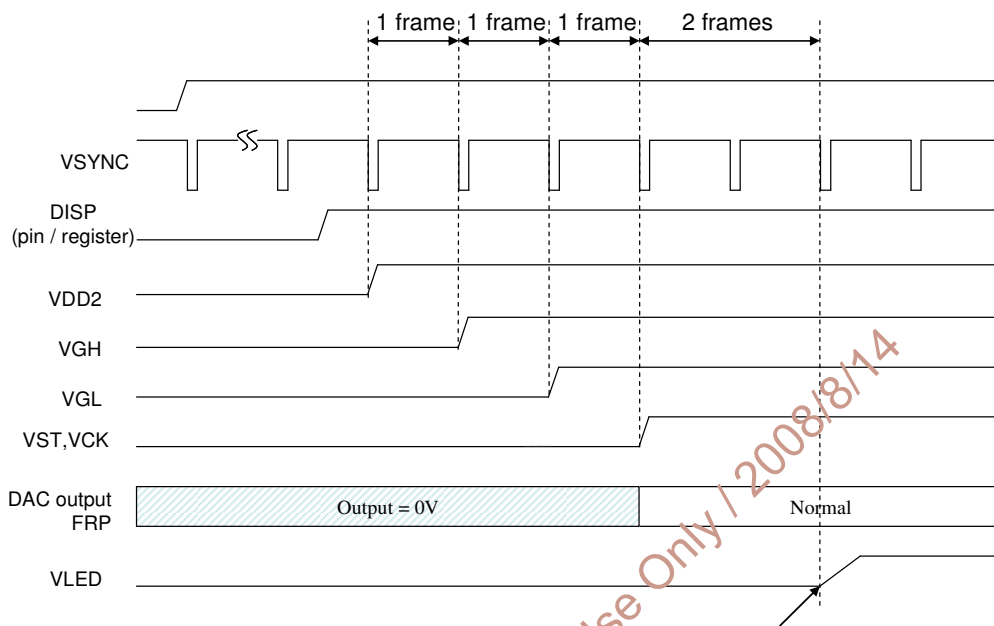

Power-Off (Display Off; Standby Enabling)

When the register DISP is set to low to enable standby mode, a build-in power off sequence is started. Please also refer to the power off sequence for the detail timing.

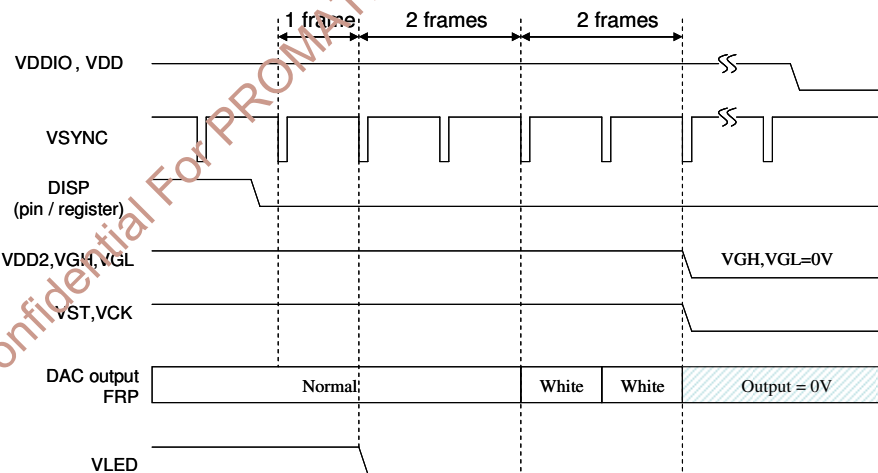

Low-voltage reset

Following figure suggests for low voltage reset function on power on sequence. When low voltage reset function enable, all the registers are loaded to default setting.

- A. The rising time (10%-90%) of VDD needs larger than 1ms.
- B. After power off, VDD needs to be keep under 0.5V more than 500ms, then it can be power on again.

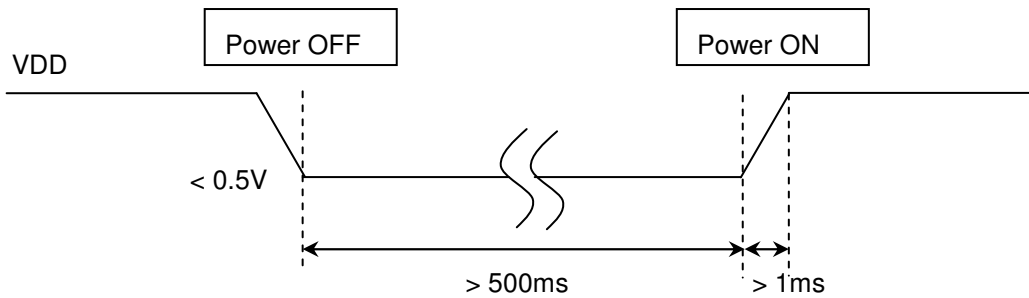

b. Timing Condition

Parameter		Symbol	Min.	Typ.	Max.	Unit.	Remark
Clock	Frequency	1/Tc	--	9.2	10	MHz	
	High Time	TCH	40	--	--	ns	
	Low Time	TCL	40	--	--	ns	
Data	Setup Time	TDS	10	--	--	ns	
	Hold Time	TDH	3	--	--	ns	
DE	Setup Time	TDES	10	--	--	ns	
	Hold Time	TDEH	3	--	--	ns	
Frame Frequency	Cycle	tv		16.7		ms	
1 Frame Scanning Time	Cycle	tv	--	288	--	H	
	Display Period	tvd	272			H	
	Front porch	tvf	2	4		H	
	Pulse width	tvp	1	10		H	
	Back porch	tvb	2	2		H	
1 Line Scanning Time	Cycle	th	490	533	545	DCLK	
	Display Period	thd	480			DCLK	
	Front porch	thf	2	8		DCLK	
	Pulse width	thp	1	41		DCLK	
	Back porch	thb	2	4		DCLK	

c. Timing Diagram

Vertical Timing of Input

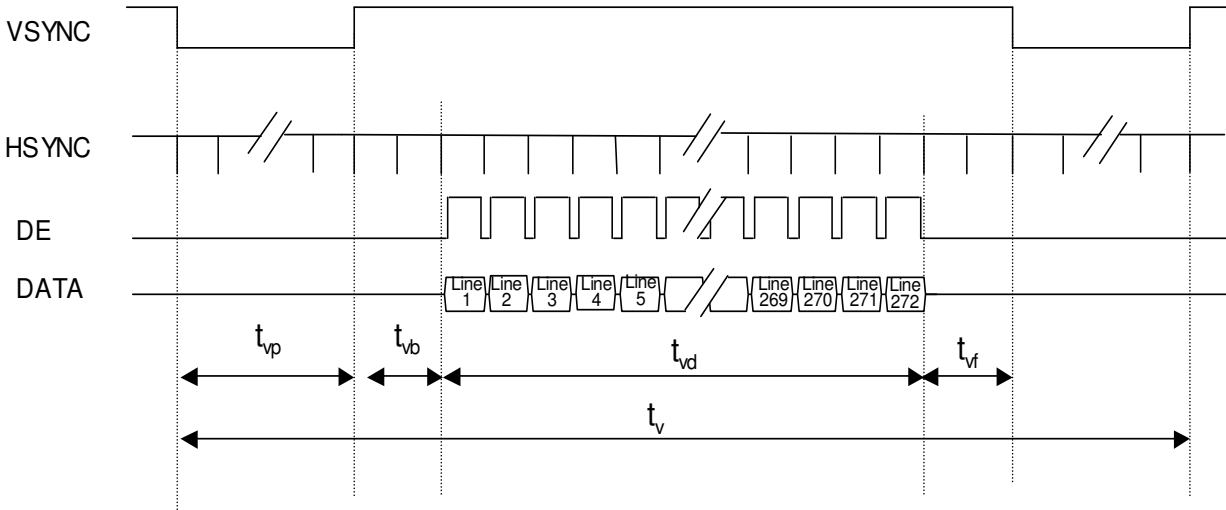

Horizontal Timing of Input

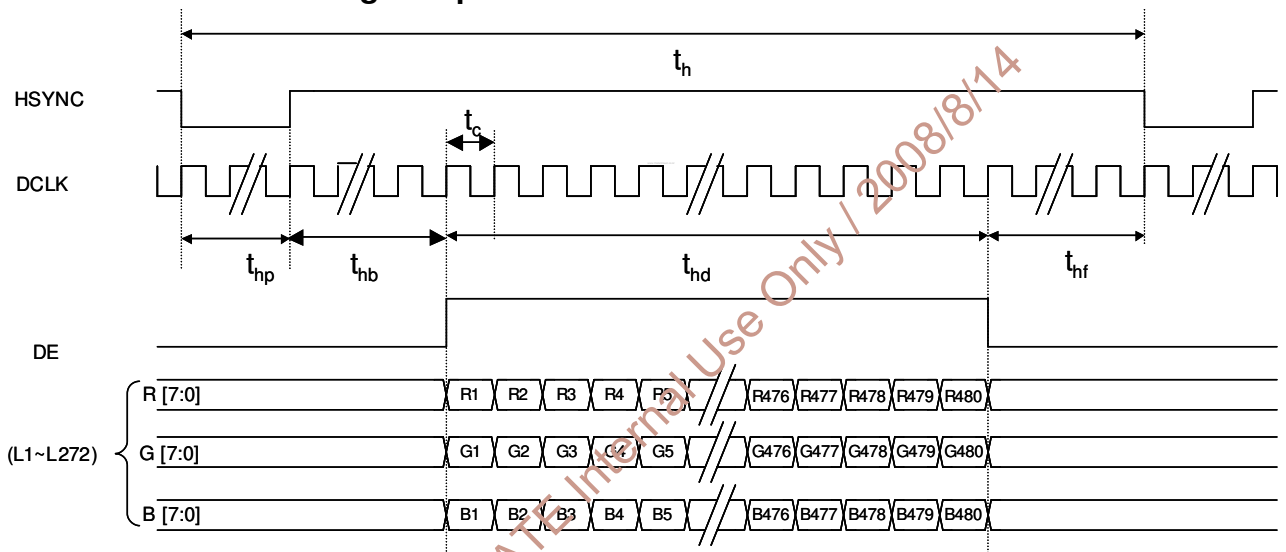

AUO Confidential For PROMATE Internal Use Only / 2008/8/14

F. Optical specifications (Note 1, 2)

Item	Symbol	Condition	Min.	Typ.	Max.	Unit	Remark
Response Time							
Rise	Tr	$\theta = 0^\circ$	-	15	25	ms	Note 3
Fall	Tf		-	20	30	ms	
Contrast ratio	CR	At optimized viewing angle	200	300	-		Note 5, 6
Viewing Angle							
Top		CR \geq 10	30	40	-	deg.	Note 7, 8
Bottom			45	55	-		
Left			50	60	-		
Right			50	60	-		
Brightness	Y_L	$\theta = 0^\circ$	300	400		cd/m ²	Note 9
White Chromaticity	X	$\theta = 0^\circ$	0.26	0.31	0.36		
	y	$\theta = 0^\circ$	0.28	0.33	0.38		

Note 1: Measurement should be performed in the dark room, optical ambient temperature =25°C, and backlight current $I_L=20$ mA

Note 2: To be measured on the center area of panel with a field angle of 1° by Topcon luminance meter BM-7, after 10 minutes operation.

Note 3: Definition of response time:

The output signals of photo detector are measured when the input signals are changed from "black" to "white" (falling time) and from "white" to "black" (rising time), respectively.

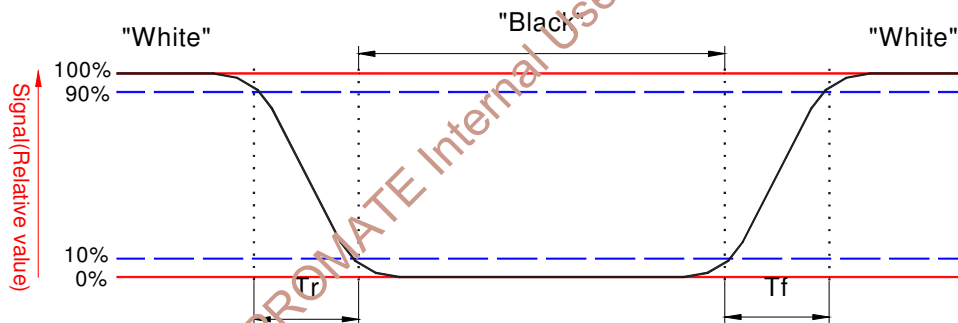

Note 4. From liquid crystal characteristics, response time will become slower and the color of panel will become darker when ambient temperature is below 25°C.

$$\text{Contrast ratio} = \frac{\text{Photo detector output when LCD is at "White" state}}{\text{Photo detector output when LCD is at "Black" state}}$$

Note 5. Contrast ratio is calculated with the following formula.

Note 6. White $V_i = V_{i50} \pm 1.5V$

Black $V_i = V_{i50} \pm 2.0V$

"±" means that the analog input signal swings in phase with COM signal.

“μ” means that the analog input signal swings out of phase with COM signal.

Vi50 :The analog input voltage when transmission is 50%

The 100% transmission is defined as the transmission of LCD panel when all the input terminals of module are electrically opened.

Note 7. Definition of viewing angle: refer to figure as below.

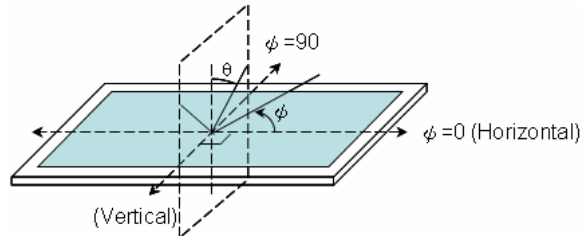

Note 8. The viewing angles are measured at the center area of the panel when all the input terminals of LCD panel are electrically opened.

Note 9. Brightness is measured at the center of the display perpendicular to the panel surface.

AUO Confidential For PROMATE Internal Use Only / 2008/8/14

G. Touch Screen Panel Specifications

1. Electrical Characteristics

Item	Min.	Max.	Unit	Remark	
Rate DC Voltage	--	7	V		
Resistance	X (Film)	500	1400	Ω	At connector
	Y (Glass)	100	700		
Linearity	1.5%	-1.5%	--	Note 1, test by 250 gf	
Chattering			ms	At connector pin	
Insulation Resistance	20	--	M Ω	DC 25V	

Note 1: Measurement condition of Linearity: difference between actual voltage & theoretical voltage is an error at any points. Linearity is the value max. error voltage divided by voltage difference on active area.

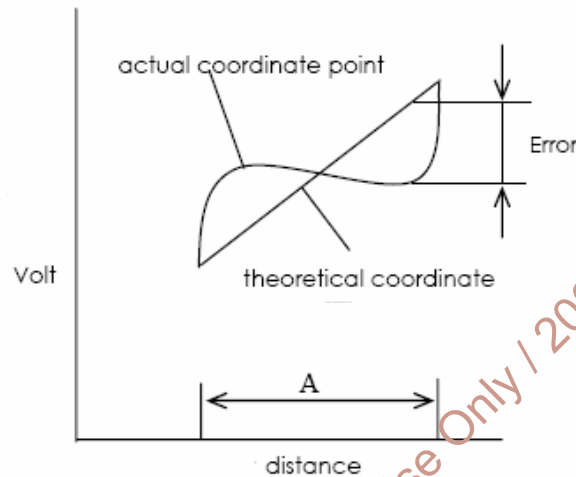

2. Mechanical Characteristics

Item	Min.	Max.	Unit	Remark
Hardness of Surface	3		H	JIS K-5400
Operation Force (Pen or Finger)		100	g	Note 1

Note 1: Within "guaranteed active area", but not on the edge and dot-spacer.

3. Life test Condition

Item	Min.	Max.	Unit	Remark
Notes Life	10 ⁵		times	Note 1, 2
Input Life	10 ⁶		times	Note 1, 3

Note 1: Measurement condition of Operation Force: Within "guaranteed active area". Resistance, Insulation resistance, and operation force should be under H.2 & H.3 condition.

4. Attention

Please pay attention for below matters at mounting design of touch panel of LCD module.

1. Do not design enclosure pressing the view area to prevent from miss input.
2. Enclosure support must not touch with view area.
3. Use elastic or non-conductive material to enclosure touch panel.
4. Do not bond film of touch panel with enclosure.
5. The touch panel edge is conductive. Do not touch it with any conductive part after mounting.
6. If user wants to clean touch panel by air gun, pressure 2kg/cm² below is suggested. Not to blow glass from FPC site to prevent FPC peeled off.
7. Do not put a heavy shock or stress on touch panel and film surface. Ex. Don't lift the panel by film face with vacuum.
8. Do not lift LCD module by FPC.
9. Please use dry cloth or soft cloth with neutral detergent (after wring dry) or one with ethanol at cleaning. Do not use any organic solvent, acid or alkali liquor.
10. Do not pile touch panel. Do not put heavy goods on touch panel.

Recommendation of the cushion area:

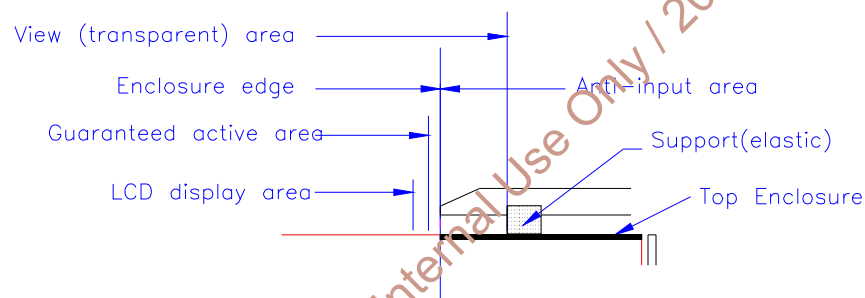

AUO Confidential For PROMATE Internal Use Only / 2008/8/14

H. Reliability Test Items

No.	Test items	Conditions		Remark
1	High Temperature Storage	Ta= 80°C	240Hrs	
2	Low Temperature Storage	Ta= -30°C	240Hrs	
3	High Temperature Operation	Ta= 70°C	240Hrs	
4	Low Temperature Operation	Ta= -20°C	240Hrs	
5	High Temperature & High Humidity	Ta= 60°C. 90% RH	240Hrs	Operation
6	Heat Shock	-25°C ~70°C, 50 cycle, 2Hrs/cycle		Non-operation
7	Vibration (With Carton)	Random vibration: 0.015G ² /Hz from 5~200Hz -6dB/Octave from 200~500Hz		IEC 68-34
8	Drop (With Carton)	Height: 60cm 1 corner, 3 edges, 6 surfaces		

Note 1: Ta: Ambient temperature.

Note 2: In the standard condition, there is not display function NG issue occurred. All the cosmetic specification is judged before the reliability stress.

AUO Confidential For PROMATE Internal Use Only / 2008/8/14

I. Packing Form

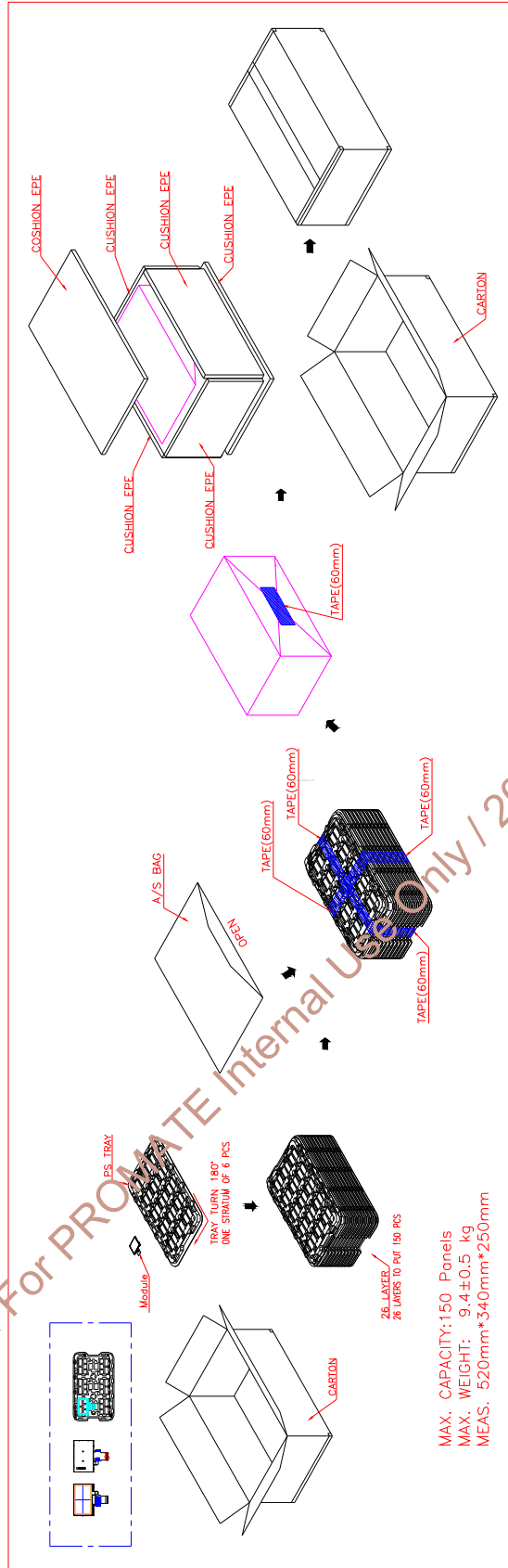

AUO Confidential For PROMATE Internal Use Only / 2008/8/14