

NTMS5838NL

Power MOSFET

40 V, 7.5 A, 25 mΩ

Features

- Low $R_{DS(on)}$
- Low Capacitance
- Optimized Gate Charge
- These Devices are Pb-Free, Halogen Free/BFR Free and are RoHS Compliant

MAXIMUM RATINGS ($T_J = 25^\circ\text{C}$ unless otherwise stated)

Parameter	Symbol	Value	Unit
Drain-to-Source Voltage	V_{DSS}	40	V
Gate-to-Source Voltage	V_{GS}	± 20	V
Continuous Drain Current $R_{\theta JA}$ (Note 1)	Steady State	$T_A = 25^\circ\text{C}$	$I_D = 5.8$ A
		$T_A = 70^\circ\text{C}$	4.6
Power Dissipation $R_{\theta JA}$ (Note 1)	Steady State	$T_A = 25^\circ\text{C}$	$P_D = 1.5$ W
		$T_A = 70^\circ\text{C}$	1.0
Continuous Drain Current $R_{\theta JA}$ (Note 1)	$t \leq 10$ s	$T_A = 25^\circ\text{C}$	$I_D = 7.5$ A
		$T_A = 70^\circ\text{C}$	6.0
Power Dissipation $R_{\theta JA}$ (Note 1)	$t \leq 10$ s	$T_A = 25^\circ\text{C}$	$P_D = 2.6$ W
		$T_A = 70^\circ\text{C}$	1.6
Pulsed Drain Current	$t_p = 10 \mu\text{s}$	$I_{DM} = 30$	A
Operating Junction and Storage Temperature	T_J, T_{STG}	-55 to +150	$^\circ\text{C}$
Source Current (Body Diode)	I_S	7.5	A
Single Pulse Drain-to-Source Avalanche Energy ($V_{DD} = 40$ V, $V_{GS} = 10$ V, $L = 0.1$ mH)	EAS	20	mJ
	IAS	20	A
Lead Temperature for Soldering Purposes (1/8" from case for 10 s)	T_L	260	$^\circ\text{C}$

Stresses exceeding Maximum Ratings may damage the device. Maximum Ratings are stress ratings only. Functional operation above the Recommended Operating Conditions is not implied. Extended exposure to stresses above the Recommended Operating Conditions may affect device reliability.

THERMAL RESISTANCE MAXIMUM RATINGS

Parameter	Symbol	Value	Unit
Junction-to-Ambient Steady State (Note 1)	$R_{\theta JA}$	83	$^\circ\text{C/W}$
Junction-to-Ambient - $t \leq 10$ s (Note 1)	$R_{\theta JA}$	49	
Junction-to-Foot (Drain) (Note 1)	$R_{\theta JF}$	22	
Junction-to-Ambient Steady State (Note 2)	$R_{\theta JA}$	123	

1. Surface-mounted on FR4 board using 1 sq-in pad (Cu area = 1.127 in sq [2 oz] including traces).
2. Surface-mounted on FR4 board using 0.155 in sq (100mm²) pad size.



ON Semiconductor®

<http://onsemi.com>

$V_{(BR)DSS}$	$R_{DS(ON) MAX}$	$I_D MAX$
40 V	25 mΩ @ 10 V	7.5 A
	30.8 mΩ @ 4.5 V	

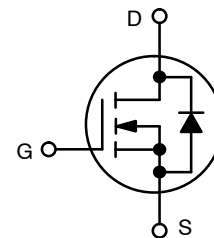

N-CHANNEL MOSFET

MARKING DIAGRAM/ PIN ASSIGNMENT



SO-8
CASE 751
STYLE 12

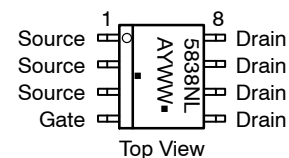

- A = Assembly Location
- Y = Year
- WW = Work Week
- = Pb-Free Package*

(*Note: Microdot may be in either location)

ORDERING INFORMATION

Device	Package	Shipping†
NTMS5838NLR2G	SO-8 (Pb-Free)	2500/Tape & Reel

†For information on tape and reel specifications, including part orientation and tape sizes, please refer to our Tape and Reel Packaging Specification Brochure, BRD8011/D.

NTMS5838NL

ELECTRICAL CHARACTERISTICS ($T_J = 25^\circ\text{C}$ unless otherwise specified)

Parameter	Symbol	Test Condition	Min	Typ	Max	Unit
-----------	--------	----------------	-----	-----	-----	------

OFF CHARACTERISTICS

Drain-to-Source Breakdown Voltage	$V_{(BR)DSS}$	$V_{GS} = 0\text{ V}, I_D = 250\ \mu\text{A}$	40			V
Drain-to-Source Breakdown Voltage Temperature Coefficient	$V_{(BR)DSS}/T_J$			32		mV/°C
Zero Gate Voltage Drain Current	I_{DSS}	$V_{GS} = 0\text{ V}, V_{DS} = 40\text{ V}$	$T_J = 25^\circ\text{C}$		1	μA
			$T_J = 125^\circ\text{C}$		100	
Gate-to-Source Leakage Current	I_{GSS}	$V_{DS} = 0\text{ V}, V_{GS} = \pm 20\text{ V}$			± 100	nA

ON CHARACTERISTICS (Note 3)

Gate Threshold Voltage	$V_{GS(TH)}$	$V_{GS} = V_{DS}, I_D = 250\ \mu\text{A}$	1.0	1.8	3.0	V
Negative Threshold Temperature Coefficient	$V_{GS(TH)}/T_J$			6.0		mV/°C
Drain-to-Source On Resistance	$R_{DS(on)}$	$V_{GS} = 10\text{ V}, I_D = 7\text{ A}$		20.5	25	$\text{m}\Omega$
		$V_{GS} = 4.5\text{ V}, I_D = 7\text{ A}$		25.0	30.8	
Forward Transconductance	g_{FS}	$V_{DS} = 15\text{ V}, I_D = 7\text{ A}$		4.0		S

CHARGES, CAPACITANCES & GATE RESISTANCE

Input Capacitance	C_{ISS}	$V_{GS} = 0\text{ V}, f = 1\text{ MHz}, V_{DS} = 20\text{ V}$		785		pF
Output Capacitance	C_{OSS}			123		
Reverse Transfer Capacitance	C_{RSS}			90		
Total Gate Charge	$Q_{G(TOT)}$	$V_{GS} = 10\text{ V}, V_{DS} = 20\text{ V}; I_D = 7\text{ A}$		17		nC
				8.6	11	
Threshold Gate Charge	$Q_{G(TH)}$	$V_{GS} = 4.5\text{ V}, V_{DS} = 20\text{ V}; I_D = 7\text{ A}$		0.8		
Gate-to-Source Charge	Q_{GS}			2.8		
Gate-to-Drain Charge	Q_{GD}			4.0		
Plateau Voltage	V_{GP}			3.2		V
Gate Resistance	R_G			1.8		Ω

SWITCHING CHARACTERISTICS (Note 4)

Turn-On Delay Time	$t_{d(ON)}$	$V_{GS} = 4.5\text{ V}, V_{DS} = 20\text{ V}, I_D = 7\text{ A}, R_G = 2.5\ \Omega$		11		ns
Rise Time	t_r			23		
Turn-Off Delay Time	$t_{d(OFF)}$			17		
Fall Time	t_f			4.0		

DRAIN-SOURCE DIODE CHARACTERISTICS

Forward Diode Voltage	V_{SD}	$V_{GS} = 0\text{ V}, I_S = 7\text{ A}$	$T_J = 25^\circ\text{C}$		0.84	1.2	V
			$T_J = 125^\circ\text{C}$		0.7		
Reverse Recovery Time	t_{RR}	$V_{GS} = 0\text{ V}, dI_S/dt = 100\text{ A}/\mu\text{s}, I_S = 7\text{ A}$		17		ns	
Charge Time	t_a			11			
Discharge Time	t_b			6.0			
Reverse Recovery Charge	Q_{RR}			10			nC

3. Pulse Test: pulse width $\leq 300\ \mu\text{s}$, duty cycle $\leq 2\%$.

4. Switching characteristics are independent of operating junction temperatures.

TYPICAL PERFORMANCE CURVES

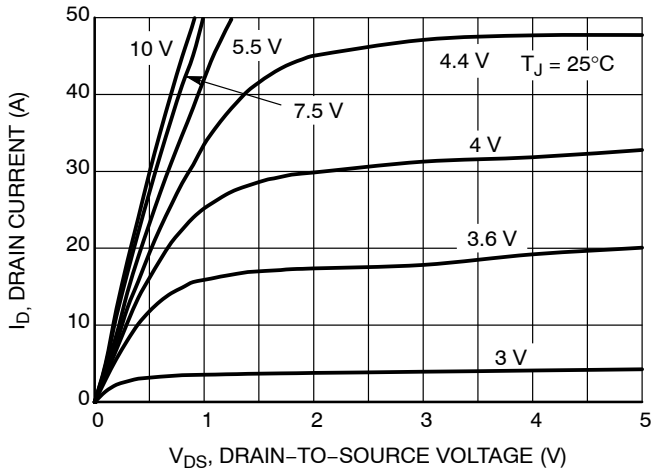

Figure 1. On-Region Characteristics

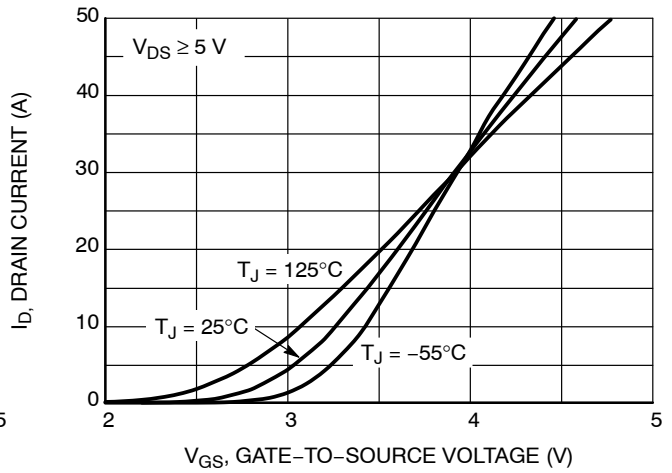

Figure 2. Transfer Characteristics

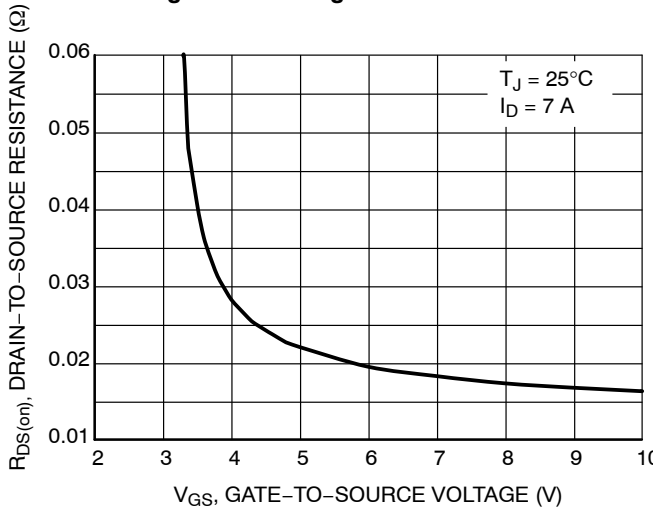

Figure 3. On-Resistance vs. Gate-to-Source Voltage

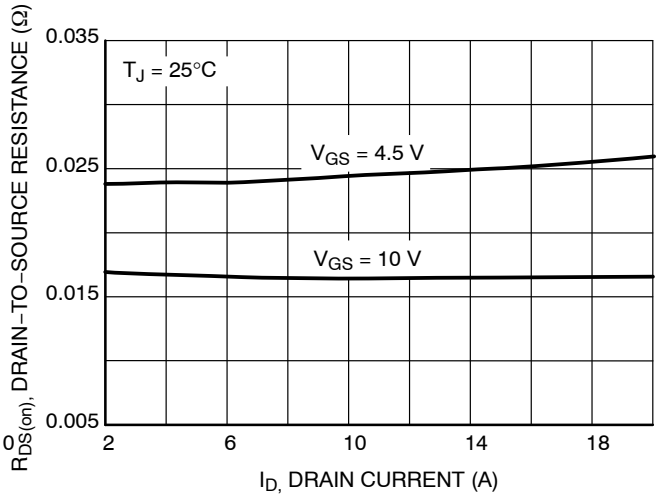

Figure 4. On-Resistance vs. Drain Current and Gate Voltage

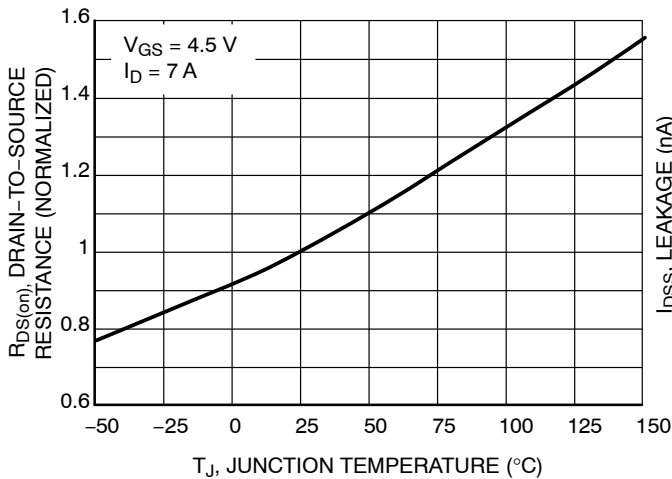

Figure 5. On-Resistance Variation with Temperature

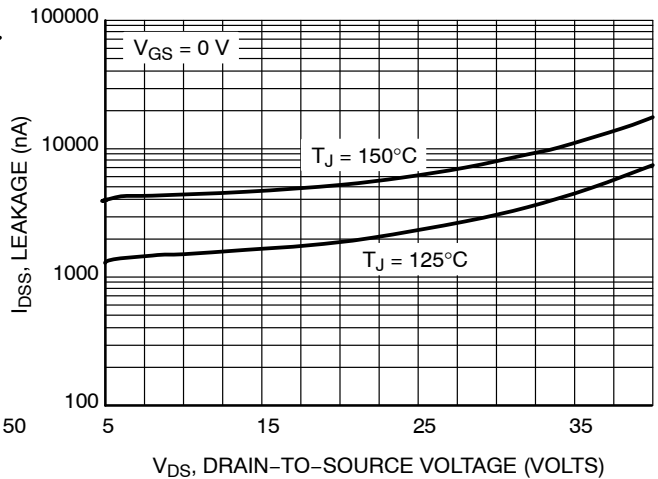

Figure 6. Drain-to-Source Leakage Current vs. Voltage

TYPICAL PERFORMANCE CURVES

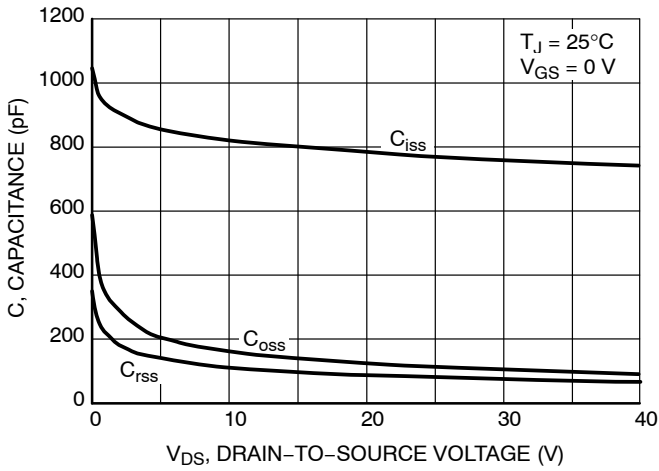

Figure 7. Capacitance Variation

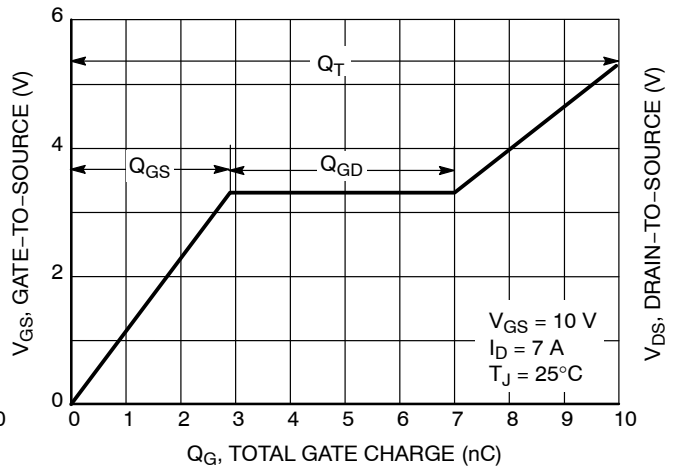

Figure 8. Gate-To-Source and Drain-To-Source Voltage vs. Total Charge

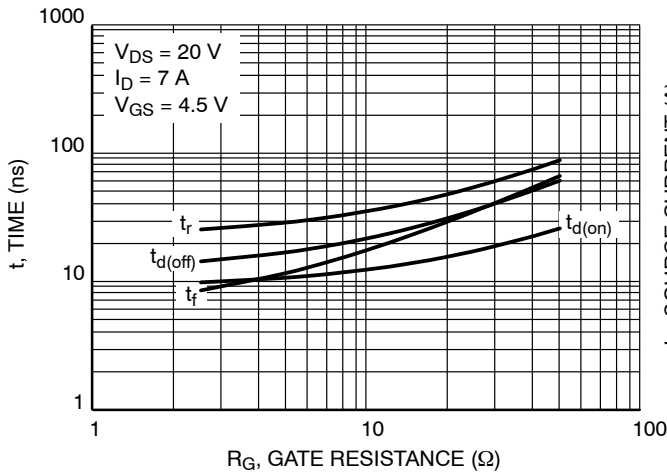

Figure 9. Resistive Switching Time Variation vs. Gate Resistance

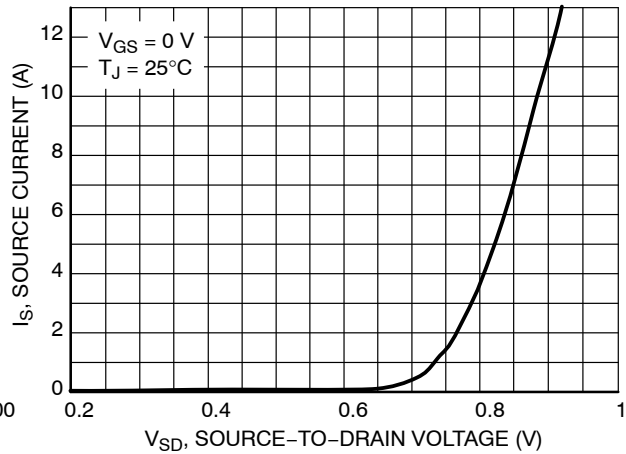

Figure 10. Diode Forward Voltage vs. Current

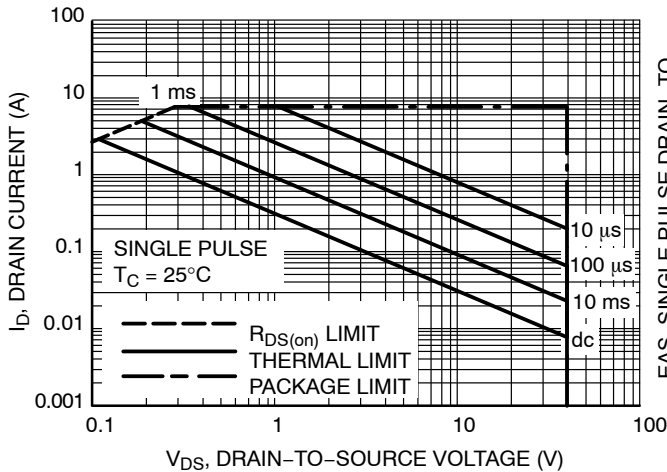

Figure 11. Maximum Rated Forward Biased Safe Operating Area

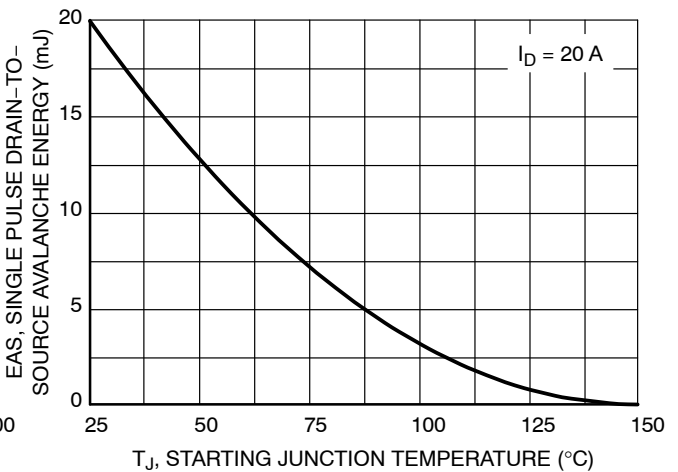

Figure 12. Maximum Avalanche Energy vs. Starting Junction Temperature

NTMS5838NL

TYPICAL PERFORMANCE CURVES

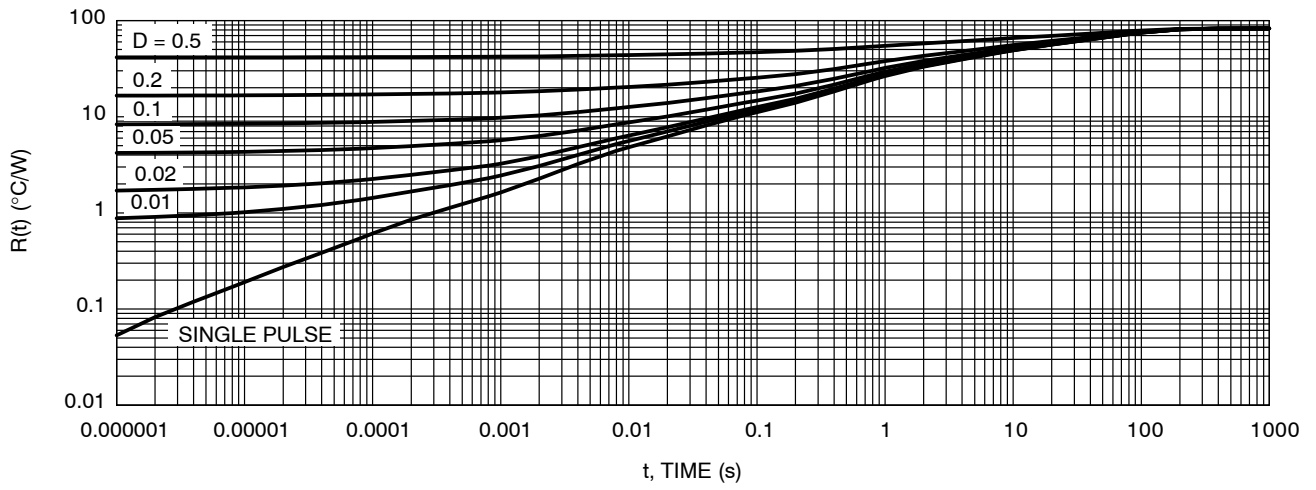
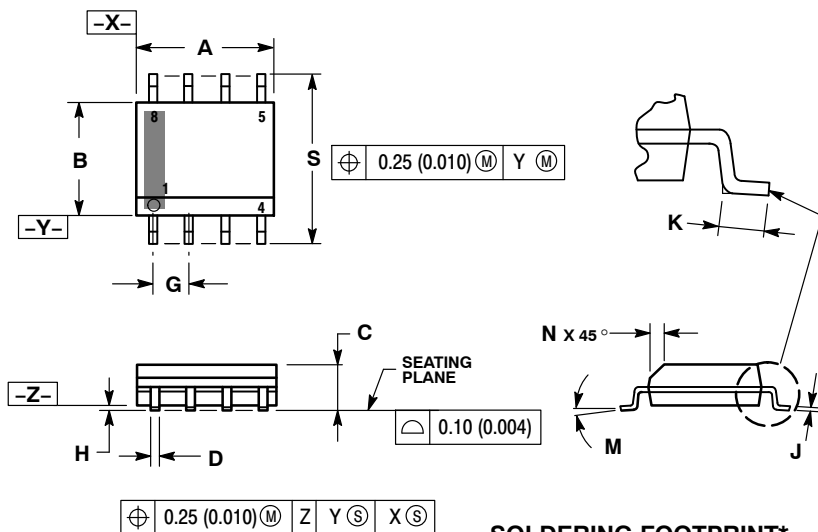

Figure 13. Thermal Response

NTMS5838NL

PACKAGE DIMENSIONS

SOIC-8 NB
CASE 751-07
ISSUE AK



NOTES:

1. DIMENSIONING AND TOLERANCING PER ANSI Y14.5M, 1982.
2. CONTROLLING DIMENSION: MILLIMETER.
3. DIMENSION A AND B DO NOT INCLUDE MOLD PROTRUSION.
4. MAXIMUM MOLD PROTRUSION 0.15 (0.006) PER SIDE.
5. DIMENSION D DOES NOT INCLUDE DAMBAR PROTRUSION. ALLOWABLE DAMBAR PROTRUSION SHALL BE 0.127 (0.005) TOTAL IN EXCESS OF THE D DIMENSION AT MAXIMUM MATERIAL CONDITION.
6. 751-01 THRU 751-06 ARE OBSOLETE. NEW STANDARD IS 751-07.

DIM	MILLIMETERS		INCHES	
	MIN	MAX	MIN	MAX
A	4.80	5.00	0.189	0.197
B	3.80	4.00	0.150	0.157
C	1.35	1.75	0.053	0.069
D	0.33	0.51	0.013	0.020
G	1.27 BSC		0.050 BSC	
H	0.10	0.25	0.004	0.010
J	0.19	0.25	0.007	0.010
K	0.40	1.27	0.016	0.050
M	0°	8°	0°	8°
N	0.25	0.50	0.010	0.020
S	5.80	6.20	0.228	0.244

SOLDERING FOOTPRINT*

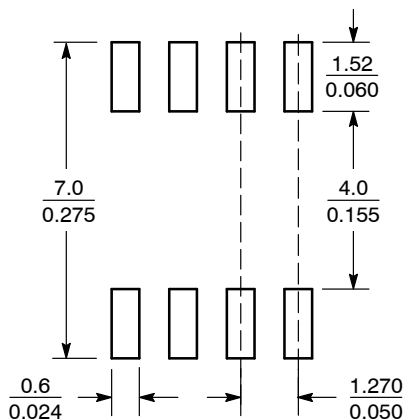

SCALE 6:1 (mm/inches)

STYLE 12:

1. SOURCE
2. SOURCE
3. SOURCE
4. GATE
5. DRAIN
6. DRAIN
7. DRAIN
8. DRAIN

*For additional information on our Pb-Free strategy and soldering details, please download the ON Semiconductor Soldering and Mounting Techniques Reference Manual, SOLDERRM/D.

ON Semiconductor and are registered trademarks of Semiconductor Components Industries, LLC (SCILLC). SCILLC reserves the right to make changes without further notice to any products herein. SCILLC makes no warranty, representation or guarantee regarding the suitability of its products for any particular purpose, nor does SCILLC assume any liability arising out of the application or use of any product or circuit, and specifically disclaims any and all liability, including without limitation special, consequential or incidental damages. "Typical" parameters which may be provided in SCILLC data sheets and/or specifications can and do vary in different applications and actual performance may vary over time. All operating parameters, including "Typicals" must be validated for each customer application by customer's technical experts. SCILLC does not convey any license under its patent rights nor the rights of others. SCILLC products are not designed, intended, or authorized for use as components in systems intended for surgical implant into the body, or other applications intended to support or sustain life, or for any other application in which the failure of the SCILLC product could create a situation where personal injury or death may occur. Should Buyer purchase or use SCILLC products for any such unintended or unauthorized application, Buyer shall indemnify and hold SCILLC and its officers, employees, subsidiaries, affiliates, and distributors harmless against all claims, costs, damages, and expenses, and reasonable attorney fees arising out of, directly or indirectly, any claim of personal injury or death associated with such unintended or unauthorized use, even if such claim alleges that SCILLC was negligent regarding the design or manufacture of the part. SCILLC is an Equal Opportunity/Affirmative Action Employer. This literature is subject to all applicable copyright laws and is not for resale in any manner.

PUBLICATION ORDERING INFORMATION

LITERATURE FULFILLMENT:
Literature Distribution Center for ON Semiconductor
P.O. Box 5163, Denver, Colorado 80217 USA
Phone: 303-675-2175 or 800-344-3860 Toll Free USA/Canada
Fax: 303-675-2176 or 800-344-3867 Toll Free USA/Canada
Email: orderlit@onsemi.com

N. American Technical Support: 800-282-9855 Toll Free USA/Canada
Europe, Middle East and Africa Technical Support:
Phone: 421 33 790 2910
Japan Customer Focus Center
Phone: 81-3-5773-3850

ON Semiconductor Website: www.onsemi.com
Order Literature: <http://www.onsemi.com/orderlit>

For additional information, please contact your local Sales Representative