

# **Acer AL1916p**

## **Service Guide**

Service guide files and updates are available on the CSD web: for more information, Please refer to <http://csd.acer.com.tw/>

## Copyright

Copyright © 2003 by Acer Incorporated. All rights reserved. No part of this publication may be reproduced, transmitted, transcribed, stored in a retrieval system, or translated into any language or computer language, in any form or by any means, electronic, mechanical, magnetic, optical, chemical, manual or otherwise, without the prior written permission of Acer Incorporated.

## Disclaimer

The information in this guide is subject to change without notice. Acer Incorporated makes no representations or warranties, either expresses or implied, with respect to the contents hereof and specifically disclaims any warranties of merchantability or fitness for any particular purpose. Any Acer Incorporated software described in this manual is sold or licensed "as is". Should the programs prove defective following their purchase, the buyer (and not Acer Incorporated, its distributor, or its dealer) assumes the entire cost of all necessary servicing, repair, and any incidental or consequential damages resulting from any defect in the software.

Acer is a registered trademark of Acer Corporation.

Intel is a registered trademark of Intel Corporation.

Pentium and Pentium II/III are trademarks of Intel Corporation.

Other brand and product names are trademarks and/or registered trademarks of their respective holders.

## Conventions

The following conventions are used in this manual:

<b>Screen messages</b>	Denotes actual messages that appear on screen
<b>Note</b>	Gives bits and pieces of additional information related to the current topic.
<b>Warning</b>	Alerts you to any damage that might result from doing or not doing specific actions.
<b>Caution</b>	Gives precautionary measures to avoid possible hardware or software problems.
<b>Important</b>	Reminds you to do specific actions relevant to the accomplishment of procedures.

## Preface

Before using this information and the product it supports, please read the following general information.

1. this Service Guide provides you with all technical information relating to the BASICCONFIGURATION decided for Acer's "global" product offering. To better fit local market requirements and enhance product competitiveness, your regional office MAY have decided to extend the functionality of a machine (e.g. add-on card, modem, or extra memory capability). These LOCALIZED FEATURES will NOT be covered in this generic service guide. In such cases, please contact your regional offices or the responsible personnel/channel to provide you with further technical details.
2. please not WHEN ORDERING FRU PARTS, that you should check the most up-to-date information available on your regional web or channel. If, for whatever reason, a part number change is made, it will not be noted in the printed Service Guide, for ACER-AUTHORIZED SERVICE PROVIDERS, your Acer office may have a DIFFERENT part number code to those given in the FRU list of this printed Service Guide. You MUST use the list provided by your regional Acer office to order FRU parts for repair and Service of customer machines.

## **WARNING: (FOR FCC CERTIFIED MODELS)**

**NOTE:** this equipment has been tested and found to comply with the limits for a Class B digital device, pursuant to Part 15 of the FCC Rules. These limits are designed to provide reasonable protection against harmful interference in a residential installation. This equipment generates, uses and can radiate radio frequency energy, and if not installed and used in accordance with the instructions, may cause harmful interference to radio communications. However, there is no guarantee that interference will not occur in a particular installation. If this equipment does cause harmful interference to radio or television reception,

Which can be determined by turning the equipment off and on, the user is encouraged to try to correct the interference by one or more of the following measures:

1. Reorient or relocate the receiving antenna.
2. Increase the separation between the equipment and receiver.
3. Connect the equipment into an outlet on a circuit different from that to which the receiver is connected.
4. Consult the dealer or an experienced radio/TV technician for help.

### **Warning**

Use only shielded signal cables to connect I/O devices to this equipment. You are cautioned that changes or modifications not expressly approved by the party responsible for compliance could void your authority to operate the equipment.

As an ENERGY STAR® Partner our company has determined that this product meets the ENERGY STAR® guidelines for energy efficiency.

## **WARNING:**

To prevent fire or shock hazard, do not expose the monitor to rain or moisture. Dangerously high voltages are present inside the monitor. Do not open the cabinet. Refer servicing to qualified personnel only.

## PRECAUTIONS

- Do not use the monitor near water, e.g. near a bathtub, washbowl, kitchen sink, laundry tub, Swimming pool or in a wet basement.
- Do not place the monitor on an unstable trolley, stand, or table. If the monitor falls, it can injure a person and cause serious damage to the appliance. Use only a trolley or stand recommended by the manufacture or sold with the monitor. If you mount the monitor on a wall or shelf, use a mounting kit approved by the manufacture and follow the kit instructions.
- Slots and openings in the back and bottom of the cabinet area provided for ventilation. To ensure reliable operation of the monitor and to protect it from overheating, be sure these openings are not blocked or covered. Do not place the monitor on a bed, sofa, rug or similar surface. Do not place the monitor near or over a radiator or heat register. Do not place the monitor in a bookcase or cabinet unless proper ventilation is provided.
- The monitor should be operated only from the type of power source indicated on the label. If you are not sure of the type of power supplied to your home, consult your dealer or local power company.
- The monitor is equipped with a three-pronged grounded plug, a plug with a third (grounding) pin. This plug will fit only into a grounded power outlet as a safety feature. If your outlet does not accommodate the three-wire plug, have an electrician install the correct outlet, or use an adapter to ground the appliance safely. Do not defeat the safety purpose of the grounded plug.
- Unplug the unit during a lightning storm or when it will not be used for long periods of time. This will protect the monitor from damage due to power surges.
- Do not overload power strips and extension cords. Overloading can result in fire or electric shock.
- Never push any object into the slot on the monitor cabinet. It could short circuit parts causing a fire or electric shock. Never spill liquids on the monitor.
- Do not attempt to service the monitor yourself; opening or removing covers can expose you to dangerous voltages and other hazards. Please refer all servicing to qualified service personnel.
- To ensure satisfactory operation, use the monitor only with UL listed computers which have appropriate configured receptacles marked between 100-240V AC, Min. 3.5A.
- The wall socket shall be installed near the equipment and shall be easily accessible.

## **SPECIAL NOTES ON LCD MONITORS**

The following symptoms are normal with LCD monitor and do not indicate a problem.

### **NOTES**

- Due to the nature of the fluorescent light, the screen may flicker during initial use. Turn off the Power Switch and then turn it on again to make sure the flicker disappears.
- You may find slightly uneven brightness in the screen depending on the desktop pattern you use.
- The LCD screen has effective pixels of 99.99% or more. It may include blemishes of 0.01% or less such as a missing pixel or a pixel lit all of the time.
- Due to the nature of the LCD screen, an afterimage of the previous screen may remain after switching the image, when the same image is displayed for hours. In this case, the screen is recovered slowly by changing the image or turning off the Power Switch for hours.

# Table of contents

<b>Chapter 1 Monitor Feature</b> .....	<b>8</b>
INTRODUCTION.....	8
ELECTRICAL REQUIREMENTS.....	9
MONITOR BLOCK DIAGRAM .....	21
BLOCK DIAGRAM .....	24
MONITOR BOARD LAYOUT .....	25
SOFTWARE FLOW CHART .....	27
GENERAL INSTRUCTIONS .....	28
SYSTEM INSTALLATION .....	29
POWER/INVERTOR BOARD .....	34
ELECTRICAL SPECIFICATION.....	35
SAFETY .....	37
<b>Chapter 2 Operating Instruction</b> .....	<b>39</b>
CONTROLS .....	39
MAIN OSD MENU.....	40
OSD MESSAGE.....	42
PLUG AND PLAY .....	44
WHITE COLOR TEMPERATURE.....	45
AUDIO TECHNICAL SPECIFICATION .....	45
<b>Chapter 3 Machine Disassembly and Replacement</b> .....	<b>47</b>
DISASSEMBLY PROCEDURE .....	47
<b>Chapter 4 Troubleshooting</b> .....	<b>50</b>
TROUBLESHOOTING.....	54
<b>Chapter 5 Connector Information</b> .....	<b>55</b>
CONNECTOR INFORMATION.....	58
<b>Chapter 6 FRU List</b> .....	<b>59</b>
PART LIST.....	55
<b>Chapter 7 Schematic Diagram</b> .....	<b>60</b>
SCHEMATIC DIAGRAM .....	60

## Monitor Feature

### INTRODUCTION

#### Scope

This specification defines the requirements for the 19" MICRO-PROCESSOR based Multi-mode supported high resolution color LCD monitor. This monitor can be directly connected to general 15 pin D-sub VGA connector and eliminates the requirement of optional special display card. It also supports VESA DPMS power management and plug & play function. There is a build-in stereo audio amplifier with volume control to drive a pair of speakers.

#### Description

The LCD monitor is designed with the latest LCD technology to provide a performance oriented product with no radiation. This will alleviate the growing health concerns. It is also a space saving design, allowing more desktop space, and comparing to the traditional CRT monitor, it consumes less power and gets less weight in addition MTBF target is 20k hours or more.

**Comparison Chart of AL1916**

	AA698T	AA698A
Panel	Normal 19" panel AU-M190EN04(V5)	Normal 19" panel Samsung-LTM190EX-L01
Signal Interface	DSUB	DSUB
Sync Type for analog input	Separate / compatible /	Separate / compatible /
Color Temp user adjust	Support	Support
DDC	DDC2B	DDC2B
Speaker	NO	NO
Headphone Jack	NO	NO
Microphone Jack	No	No
USB Hub	Not support	Not support
Tilt / Swivel	Yes / No	Yes / No
Height Adjust	Option	Option



# ELECTRICAL REQUIREMENTS

## Standard Test Conditions

All tests shall be performed under the following conditions, unless otherwise specified.

<b>Ambient light :</b>	225 lux
<b>Viewing distance :</b>	50 cm in front of LCD panel
<b>Warrn up time</b>	
All specifications :	30 minutes
Fully functional :	5 seconds
<b>Measuring Equipment :</b>	Chroma 2250 signal generator or equivalent, directly Connected to the monitor under test. Minolta CA100 photometer, or equivalent
<b>Control settings</b>	
User brightness control :	Maximum (unless otherwise specified )
User contrast control:	Typical (unless otherwise specified )
<b>User red/white balance, Green/white balance and Blue/white balance control :</b>	
	In the center (unless otherwise specified )
<b>Power input:</b>	110Vac or 230Vac
<b>Ambient temperature:</b>	20 ± 5 °C ( 68 ± 9 ° F)
<b>Analog input mode:</b>	1280 x1024 /60 Hz

## MEASUREMENT SYSTEMS

The units of measure stated in this document are listed below:

1 gamma = 1 nano tesla

1 tesla = 10,000 gauss

cm = in x 2.54

lb = kg x 2.2

degrees F = [°C x 1.8] + 32

degrees C = [°F - 32]/1.8

$u' = 4x/(-2x + 12y + 3)$

$v' = 9y/(-2x + 12y + 3)$

$x = (27u'/4)/[(9u'/2) - 12v' + 9]$

$y = (3v')/[(9u'/2) - 12v' + 9]$

nits = cd/(m<sup>2</sup>) = Ft-L x 3.426

lux = foot-candle x 10.76

## LCD monitor General specification

<b>Panel Type:</b>	19 " active matrix color TFT LCD
	1). LG LM190E03-B4
	2). LG LM190E03-B4N9
	3). Samsung LTM190EX-L01
	4). AU M190EN04 V5
<b>Display size:</b>	376.32mm (H) × 301.056mm(V)
<b>Display mode:</b>	VGA 720 × 400 (70 Hz)
	VGA 640 × 480 (60/66/70/72/75 Hz)
	SVGA 800 × 600 (60/70/72/75 Hz)
	XGA 1024 × 768 (60/70/75 Hz)
	SXGA 1280 × 1024 (60/70/75 Hz) standard resolution
<b>Pixel pitch:</b>	0.294mm(H) × 0.294mm(V)

<b>Display Dot:</b>	1280 x (RGB) × 1024		
<b>Pixel Clock:</b>	25.2 – 135.0MHz		
<b>Contrast ratio: <math>\theta = 0^\circ</math></b>	LG: 500:1 (typical)	Samsung: 700:1 (typical)	AU: 550:1 (typical)
<b>Brightness:</b>	LG: 250 (typical)	Samsung: 300 (typical)	AU: 270 (typical)
<b>Response time (Tr/Tf):</b>	LG	Ta=25°C, 2/10ms (typical)	
	Samsung	Ta=25°C, 1.7/6.3ms (typical)	
	AU	Ta=25°C, 5.6/2.4ms (typical)	
<b>Display color:</b>	LG	16.2M color with FRC	
	Samsung	16.7M	
	AU	16.2M color with FRC	
<b>Viewing angle(CR&gt;10):</b>	LG	L / R $\geq 70 / \geq 70$	
		U / D $\geq 70 / \geq 70$	
	Samsung	L / R $\geq 75 / \geq 75$	
		U / D $\geq 75 / \geq 60$	
	AU	L / R $\geq 70 / \geq 70$	
		U / D $\geq 75 / \geq 60$	
<b>Luminance Uniformity:</b>	LG	< 1.3 (max)	
	Samsung	< 25 % (max)	
	AU	>70% (min)	

## LCD Panel Specification

### LCD Panel Model (AU-M190EN04(V5))

- Display Type active matrix color TFT LCD
- Resolution 1280 x 1024 pixels
- Display Dot 1280 x (RGB) x 1024
- Display Area 376.32mm(H) x 301.06mm(V)
- Pixel Pitch 0.098x3mm(H) x 0.294mm(V)
- Display Color 16777216
- Lamp Voltage 700 Vrms typ.
- Lamp Current 7mA rms.( typ). 4 Lamp
- Weight 2700g .
- Optical Specifications

The following items are measured under stable conditions. The optical characteristics should be measured in a dark room or equivalent state with the methods shown in Note(4).

◆Measuring equipment : TOPCON BM-5A, BM-7, PHOTO RESEARCH PR650

(Inverter Freq. : 54kHz) \*Ta =25 ± 2°C, VDD=5V, fv=60 Hz, fDCLK=54 MHz, IL= 7mArms

Item	Symbol	Condition	Min.	Typ.	Max.	Unit	Note	
Contrast Ratio (Center of screen)	CR		350	550	-		(1)(2)(4) BM-5A	
Response Time	Rising	Normal $\phi = 0^\circ$ $\theta = 0^\circ$	-	5.6	8.4	msec	(1)(3) BM-7	
	Falling		-	2.4	3.6			
Luminance of White (Center of screen)	YL		215	270	-	cd/m2	(5) BM-5A	
Color Chromaticity (CIE 1931)	Red	Viewing Angle	TYP. -0.03	0.634	TYP. +0.03		(1)(4) PR650	
				Ry				0.354
	Green			Gx				0.287
				Gy				0.621
	Blue			Bx				0.138
				By				0.077
	White			Wx				0.313
				Wy				0.329
Viewing Angle	Hor.	CR≥10	65	70	-	Degrees	(1)(4) BM-5A	
			$\theta_R$	65	70-			-
	Ver.		$\phi_H$	65	70-			-
			$\phi_L$	55	60-			-
Brightness Uniformity (9 points)	BUNI		70	75-	-	%	(6) BM-5A	

### LCD Panel Model (Samsung-LTM190EX-L01)

- Display Type active matrix color TFT LCD
- Resolution 1280 x 1024 pixels
- Display Dot 1280 x (RGB) x 1024
- Display Area 376.32mm(H) x 301.056mm(V)
- Pixel Pitch 0.098x3mm(H) x 0.294mm(V)
- Display Color 16777216

- Lamp Voltage 650 Vrms typ.
- Lamp Current 7.5mA rms.( typ). 4 Lamp
- Weight 2250g .
- Optical Specifications

The following items are measured under stable conditions. The optical characteristics should be measured in a dark room or equivalent state with the methods shown in Note(4).

◆Measuring equipment : TOPCON BM-5A, BM-7, PHOTO RESEARCH PR650

(Inverter Freq. : 54kHz) \*Ta =25 ± 2°C, VDD=5V, fv=60 Hz, fDCLK=54 MHz, IL= 7mArms

Item	Symbol	Condition	Min.	Typ.	Max.	Unit	Note					
Contrast Ratio (Center of screen)	CR	Normal $\phi = 0^\circ$ $\theta = 0^\circ$	450	700	-		(1)(2)(4) BM-5A					
Response Time	Rising		$T_R$	-	1.7	3	msec	(1)(3) BM-7				
	Falling		$T_F$	-	6.3	9						
Luminance of White (Center of screen)	$Y_L$	Viewing Angle	250	300	-	cd/m2	(5) BM-5A					
Color Chromaticity (CIE 1931)	Red		$R_x$	TYP. -0.03	0.640	TYP. +0.03		(1)(4) PR650				
			$R_y$		0.329							
	Green		$G_x$		0.300							
			$G_y$		0.600							
	Blue		$B_x$		0.150							
			$B_y$		0.060							
	White		$W_x$		0.313							
			$W_y$		0.329							
	Viewing Angle		Hor.		$\theta_L$		CR≥10		65	75	-	Degrees
		$\theta_R$			65				75	-		
Ver.		$\phi_H$	65	75-	-							
		$\phi_L$	50	60-	-							
Brightness Uniformity (9 points)	BUNI				25	%	(6) BM-5A					

Note 1) Definition of Viewing Angle: Viewing angle range ( $10 \leq CR$ )

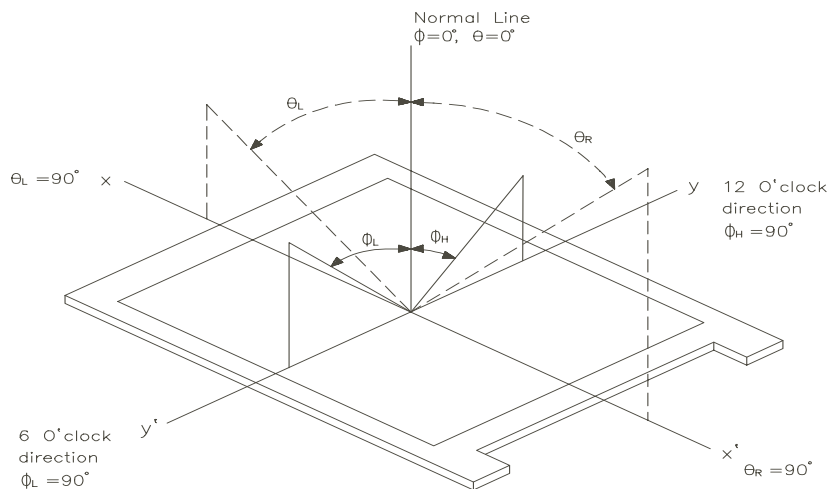

ST350-E01

Note 2) Definition of Contrast Ratio (CR): Ratio of gray max(Gmax),gray min(Gmin) at the center point of panel.

$$CR = \frac{\text{Luminance with all pixels white (Gmax)}}{\text{Luminance with all pixels black (Gmin)}}$$

Note 3) Definition of Response time: Sum of  $T_R$ ,  $T_F$

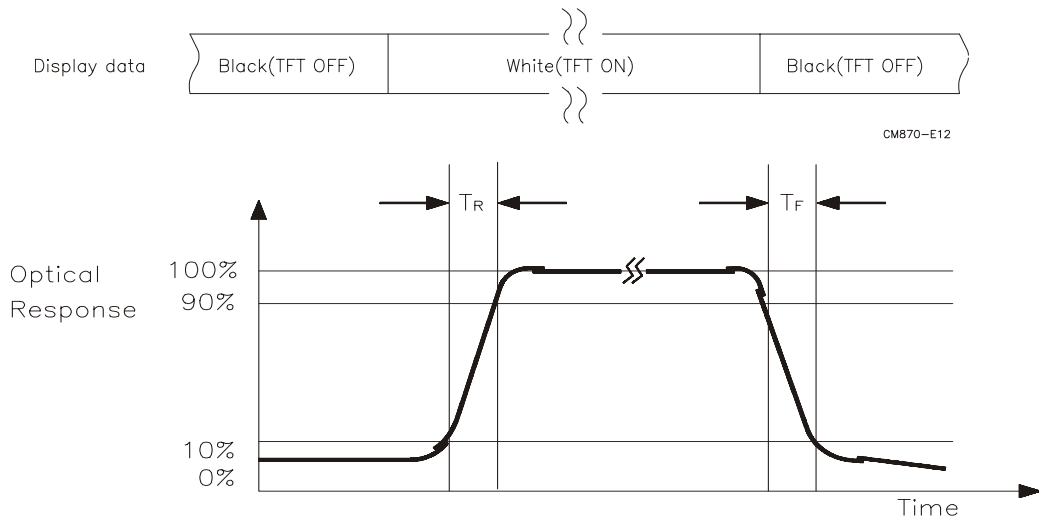

CM870-E12

CM870-E12

Note 4) After stabilizing and leaving the panel alone at a given temperature for 30 min, the measurement should be executed. Measurement should be executed in a stable, windless, and dark room. 30 min after lighting the back-light. This should be measured in the center of screen. Dual lamp current :13.0mA(6.5mA x2)(Refer to the note(1) in the page 14 for more information ).

Environment condition : $T_a=25\pm 2^\circ\text{C}$

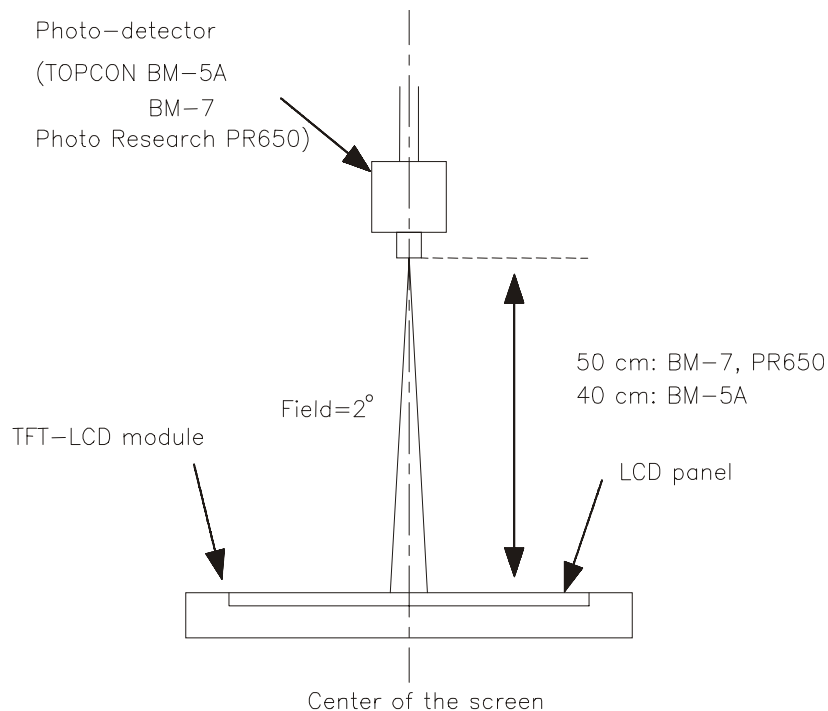

CM870-B08

## Optical characteristics measurement setup

Notes 5) Definition of Luminance of White : measure the luminance of white at center point.

Brightness uniformity of these 9 points is defined as below

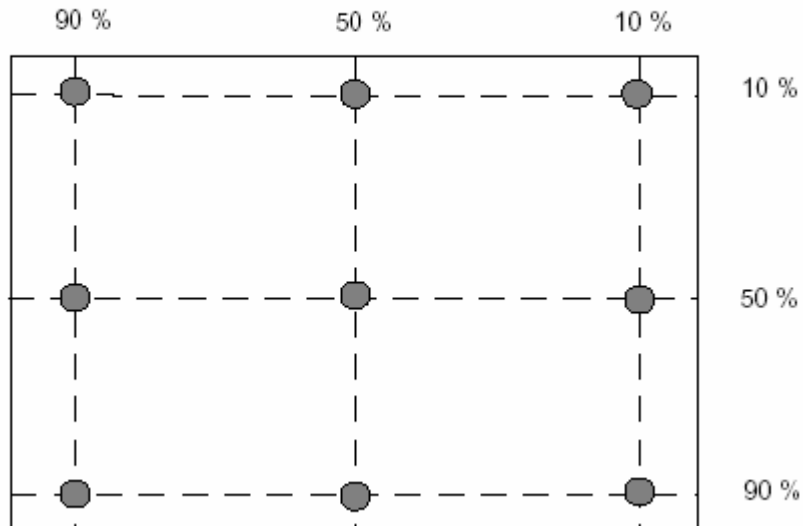

Notes 6) Definition of 9 points brightness uniformity (Measuring points: Refer to the Note 5)

**AU**

$$B_{UNI} = \frac{B_{min}}{B_{max}} \times 100\%$$

**Samsung**

$$B_{UNI} = \frac{B_{max} - B_{min}}{B_{max}} \times 100\%$$

Bmax: Maximum brightness

Bmin: Minimum brightness

Notes 7) Definition of Flicker level

$$F = \frac{\text{Flicker Voltage}_{pp}}{\text{LMD Voltage}_{dc}} \times 100\%$$

- ◆ One maximum value of three estimated values.
- ◆ For this test ,an LMD(Light Measurement Device)is needed with adequate response time to track any visible rate flicker component and with a voltage level output proportional To luminance intensity.
- ◆ Test Pattern: For dot inversion Driving(Gray levels of foreground dots on the test panel Are G22,G32,and G45)

- ◆ Test Point :Center point of the display area

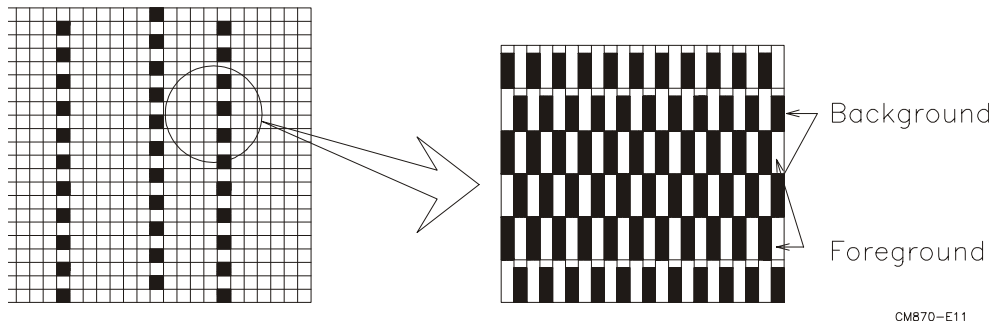

CM870-E11

Note 8) Definition of Crosstalk (Refer to the VESA STD)

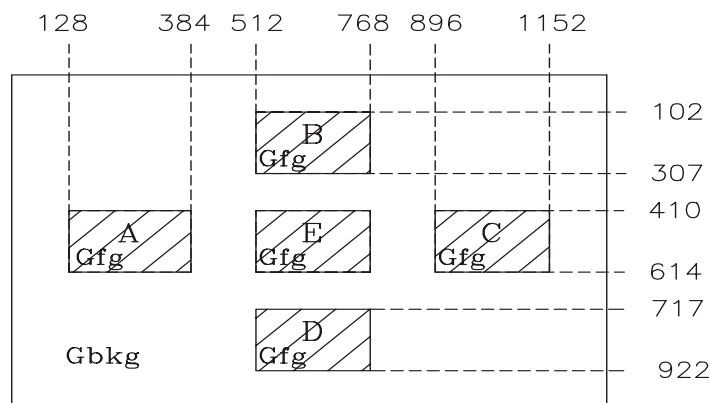

CM870-E10

The calculation for shadowing is made from the 2 luminance measurements Gbkg and Lsh, as follows:

$$C_T = \frac{L_{max} - L_{min}}{L_{min}} \times 100 \%$$

Where Lmax is the larger value of Gbkg or Lsh , and Lmin is the smaller of the two.

- ◆ To determine background and foreground levels (colors), first set the background to any gray scale or color level suitable for shadowing determination. (Note that it may take several iterations of adjusting background level and box levels to determine the proper value for the background. Next display the box levels to determine the proper value for the background level. Look for shadowing in any direction from box E. Independently vary the gray level (or color) of the background and box E until the worst case shadowing is observed. This defines the background (Gbkg) and foreground (Gfg) levels to be maintained for the remainder of the test.
- ◆ One point only (the target) will be measured. To determine that point proceed as follows Using the background and foreground gray levels of step1 (Gbkg and Gfg). Turn on each box at a time. Look for the case with the worst shadowing. The box causing the worst case is the shadowing source, or Bsrc. Use Bsrc and the box opposite from it that lies directly in the shadow path. That is the target box, or Btgt. Note that box Eight be either Bsrc or Btgt, depending on the shadowing conditions, but typically Bsrc and Btgt will be a pair of

opposite boxes, A&C or B&D. Btgt will only be displayed for aligning the LMD. It will be turned off for the actual measurement.

- ◆ The target box point (Btgt) will be measured with the source box (Bsrc) turned on then off. (Btgt is for alignment purpose only) Display the background only at level Gbkg. Display Btgt determined in step 2 above. Using the correct distance, angle, and measurement aperture, align the LMD to the center of the Btgt. Turn off Btgt. With Gbkg set to its proper level, measure the luminance (or color). Next, turn on the source box Bsrc. Again measure at the center point of Btgt (without Btgt present.). In this case the LMD will be measuring the shadowing level, Lsh.

## Panel Relative Humidity

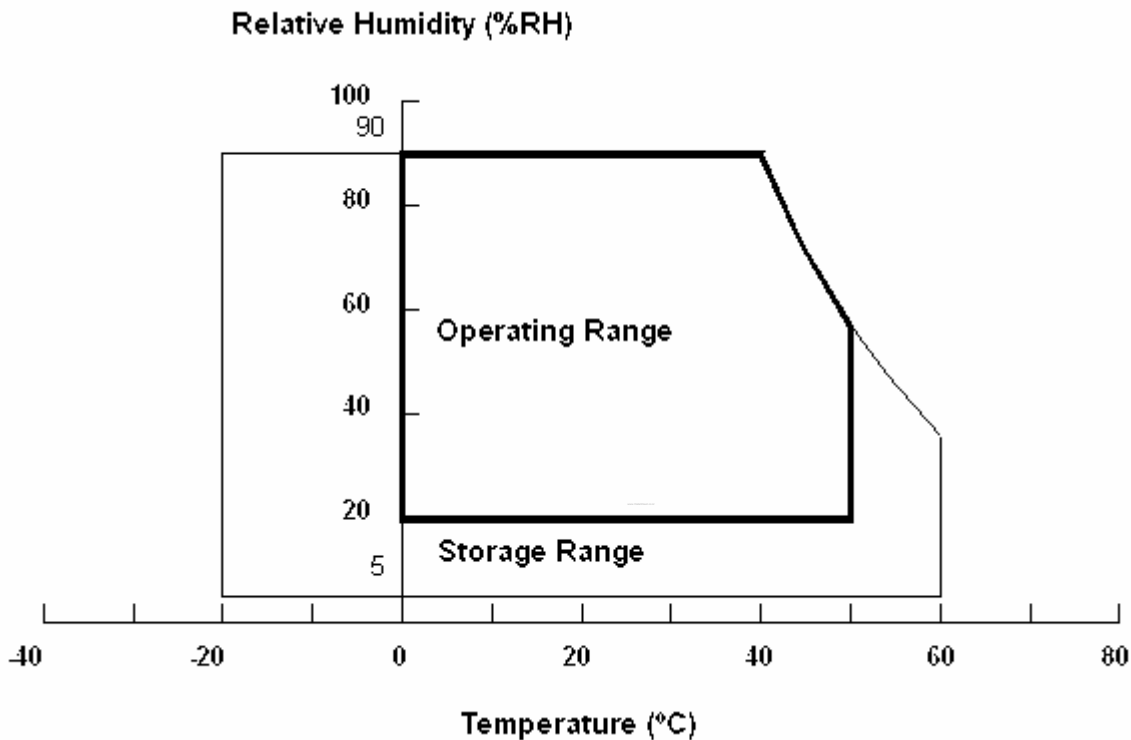

## Input Signals

### Video input

- Type Analog R, G, B.
- Input Impedance 75 ohm +/- 2%
- Polarity Positive
- Amplitude 0 - 0.7 +/- 0.05 Vp
- Display Color same as LCD panel

### Sync input

- Signal separate horizontal and vertical sync, or composite sync which are TTL compatible
- Polarity positive and negative.



## **Interface frequency**

The following frequency range is generalized by supported timing. If the entered mode does not match the supported timing the display optimization will not be assured.

- Horizontal Frequency 24KHz --80KHz
- Vertical Frequency 49Hz -----75Hz

## Supported Timing

TIMING	FH(KHZ)	SYNC	TOTAL	ACTIVE	SYNC	FRONT	BACK	PIXEL
	FV(HZ)	POLARITY	(DOT/LINE)	(DOT/LINE)	WIDTH (DOT/LINE)	PORCH (DOT/LINE)	PORCH (DOT/LINE)	FOREQ.(MHZ)
640x350	31.469	+	800	640	96	16	48	25.175
VGA-350	70.087	-	449	350	2	37	60	
640x400	24.83	-	848	640	64	64	80	21.05
NEC PC9801	56.42	-	440	400	8	7	25	
640x400	31.469	-	800	640	96	16	48	25.175
VGA-GRAPH	70.087	+	449	400	2	12	35	
640x400	31.5	-	800	640	64	16	80	25.197
NEC PC9821	70.15	-	449	400	2	13	34	
640X480	31.469	-	800	640	96	16	48	25.175
VESA-PAL	50.030	-	629	480	2	62	85	
640x480	31.469	-	800	640	96	16	48	25.175
VGA-480	59.94	-	525	480	2	10	33	
640x480	35.00	-	864	640	64	64	96	30.24
APPLE MAC-480	66.67	-	525	480	3	3	39	
640x480	37.861	-	832	640	40	16	120	31.5
VESA-480-72Hz	72.809	-	520	480	3	1	20	
640x480	37.5	-	840	640	64	16	120	31.5
VESA-480-75Hz	75	-	500	480	3	1	16	
720x400	31.469	-	900	720	108	18	54	28.322
VGA-400-TEXT	70.087	+	449	400	2	12	35	
832x624	49.725	-	1152	832	64	32	224	57.2832
APPLE MAC-800	74.55	-	667	624	3	1	39	
800x600	35.156	+	1024	800	72	24	128	36
SVGA	56.25	+	625	600	2	1	22	
800x600	37.879	+	1056	800	128	40	88	40
VESA-600-60Hz	60.317	+	628	600	4	1	23	
800x600	48.077	+	1040	800	120	56	64	50
VESA-600-72Hz	72.188	+	666	600	6	37	23	
800x600	46.875	+	1056	800	80	16	160	49.5
VESA-600-75Hz	75	+	625	600	3	1	21	
1024x768	48.363	-	1344	1024	136	24	160	65
XGA	60.004	-	806	768	6	3	29	
1024x768	53.964	+	1328	1024	176	16	112	71.664
COMPAQ-XGA	66.132	+	816	768	4	8	36	
1024x768	56.476	-	1328	1024	136	24	144	75
VESA-768-70Hz	70.069	-	806	768	6	3	29	
1024x768	60.023	+	1312	1024	96	16	176	78.75
VESA-768-75Hz	75.029	+	800	768	3	1	28	
1024x768	60.24	-	1328	1024	96	32	176	80
APPLE MAC-768	75.02	-	803	768	3	3	29	
1152x864	54.054	+	1480	1152	96	40	192	80
(60Hz)	59.270	+	912	864	3	13	32	
1152x864	63.851	+	1480	1152	96	32	200	94.499
(70Hz)	70.012	+	912	864	3	1	44	
1152x864	67.50	+	1600	1152	128	64	256	108.00
(75Hz)	75.00	+	900	864	2	2	32	
1280x960	60.00	+	1800	1280	112	96	312	108.00
(60Hz)	60.00	+	1000	960	3	1	36	
1280x960	70.00	+	1800	1280	112	96	312	126.00
(70Hz)	70.00	+	1000	960	3	1	36	
1280x960	75.00	+	1800	1280	112	96	312	135.00
(75Hz)	75.00	+	1000	960	3	1	36	
1280x1024	64	+	1688	1280	112	48	248	108
VESA-1024-60Hz	60	+	1066	1024	3	1	38	
1280x1024	80	+	1688	1280	144	16	248	135
VESA-1024-75Hz	75	+	1066	1024	3	1	38	

Note: Mode 640x350, 640x400 and 720x400 will locate on middle position but cannot be expanded to full screen on vertical direction

## Support Modes

There will be 28 total support modes to accommodate the above mode and other video modes within the frequency range of the monitor.

## 85Hz refresh rate Support

Monitor should display 85Hz refresh rate mode as emergency mode.

Monitor should display “Out of Range” warning menu at this mode.

## Video input Connector

### Analog Video input Connector: 15pins mini D-Sub

Table 2.4.5. Pin assignment for D-sub connector

PIN NO.	Separate Sync
1	RED VIDEO
2	GREEN VIDEO
3	BLUE VIDEO
4	GROUND
5	GROUND
6	RED GROUND
7	GREEN GROUND
8	BLUE GROUND
9	PC5V (+5V DDC)
10	CABLE DETECTION
11	GROUND
12	SDA
13	H.SYNC
14	V.SYNC
15	SCL

Color of plastic parts: Blue (PC99)

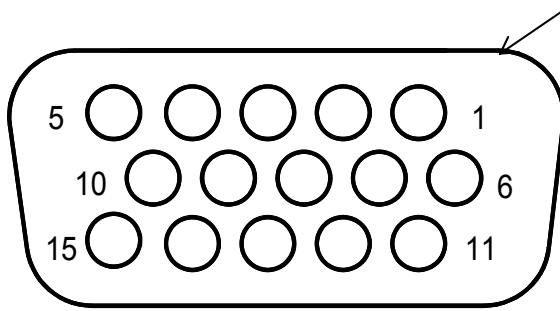

D-sub connector

**Digital Video Input Connector : DVI – D (T.B.D)**

Table 2.4.6 Pin assignment for DVI – D Connector:

Pin – Assignment of DVI –D connector :					
1	TX2-	9	TX1-	17	TX0-
2	TX2+	10	TX1+	18	TX0+
3	Shield (TX2 / TX4)	11	Shield (TX1 / TX3)	19	Shield (TX0 / TX5)
4	NC	12	NC	20	NC
5	NC	13	NC	21	NC
6	DDC-Serial Clock	14	+5V power *)	22	Shield (TXC)
7	DDC-Serial Data	15	Ground (+5V)	23	TXC+
8	No Connect	16	Hot plug detect	24	TXC-

\*) In case, the power of the PC unit is switched off and the power of the monitor is switched on, no voltage may occur at pin 14.

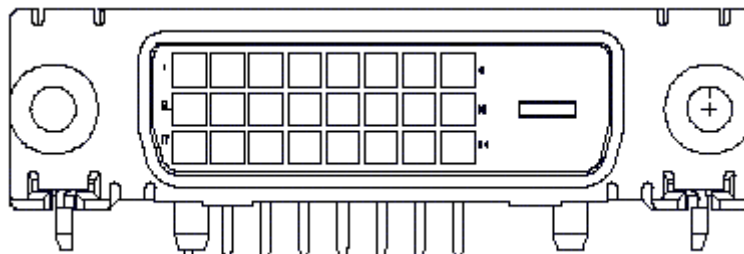

# MONITOR BLOCK DIAGRAM

The LCD monitor will contain an main board, an inverter/ power board, key board and internal adapter which house the flat panel control logic, brightness control logic and DDC.

The inverter board will drive the backlight of panel and the DC-DC conversion.

The Adapter will provide thr 12V DC-power to inverter/ power board.

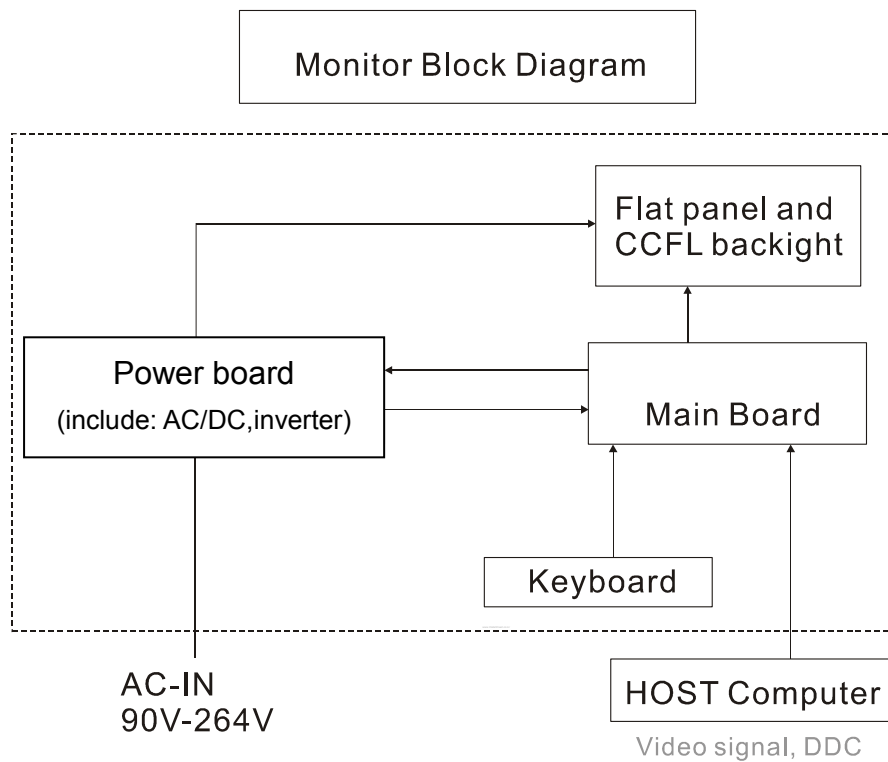

# BLOCK DIAGRAM

## System Block Diagram

1.

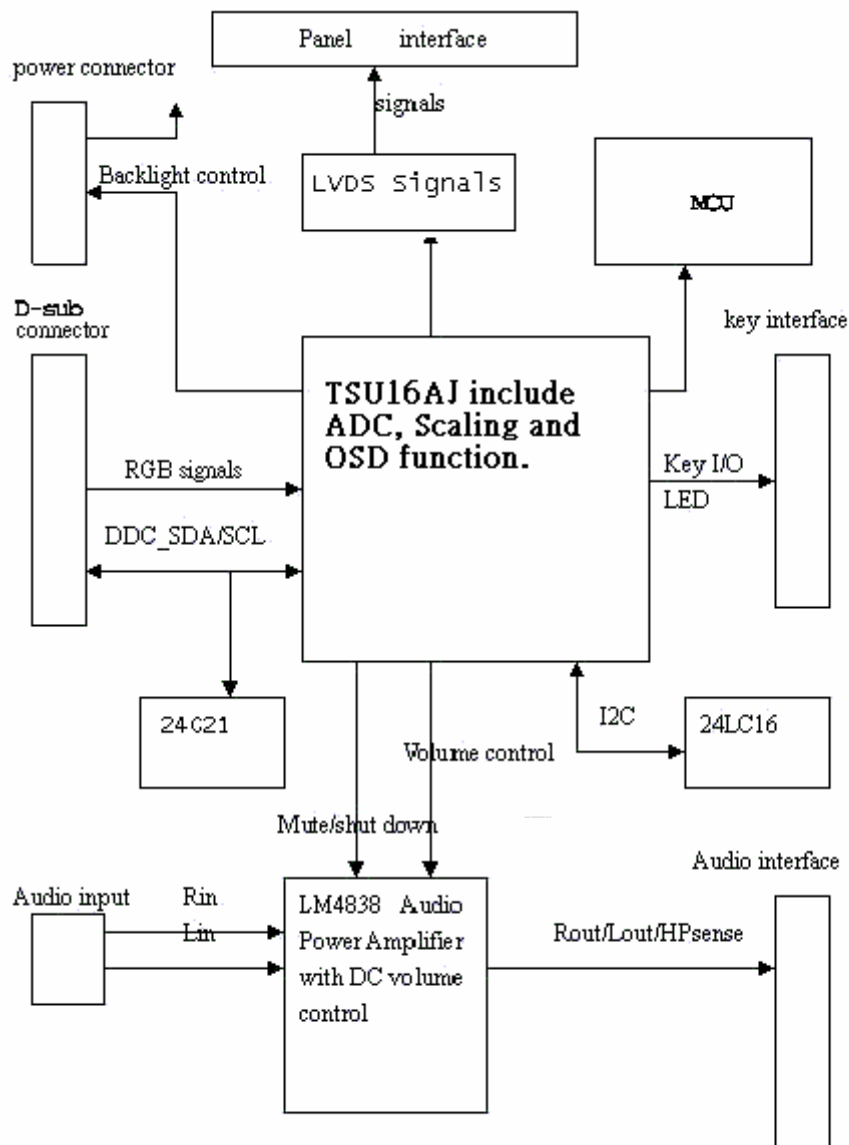

2.

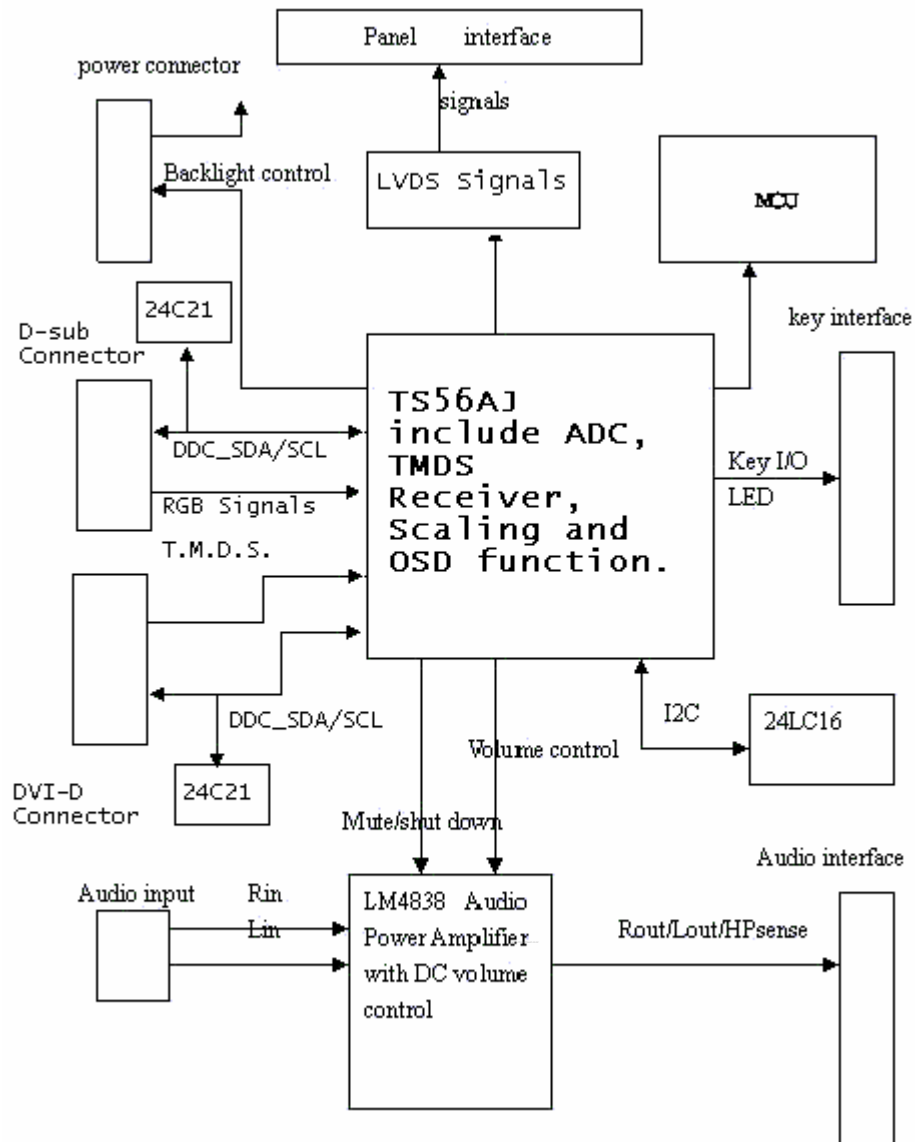

3.

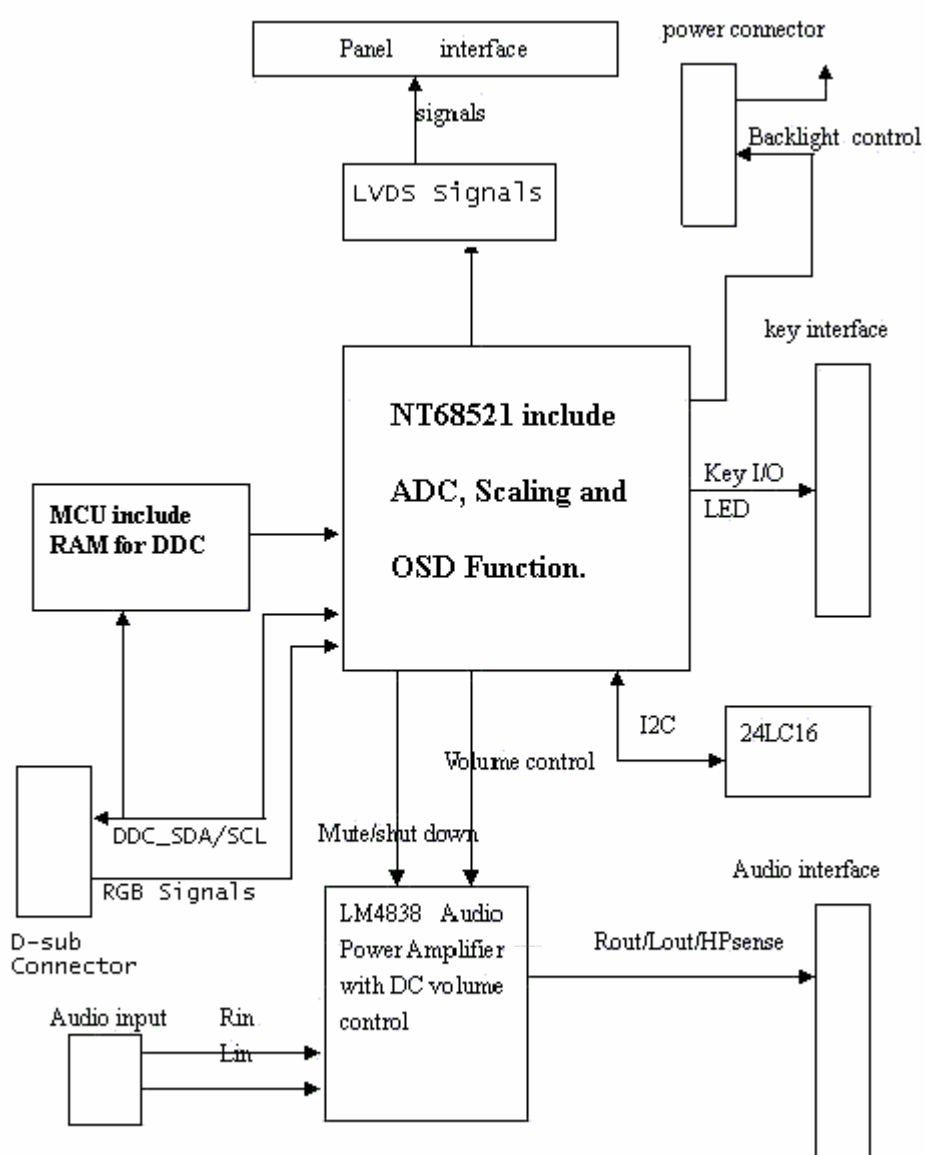



# Monitor board layout

1.

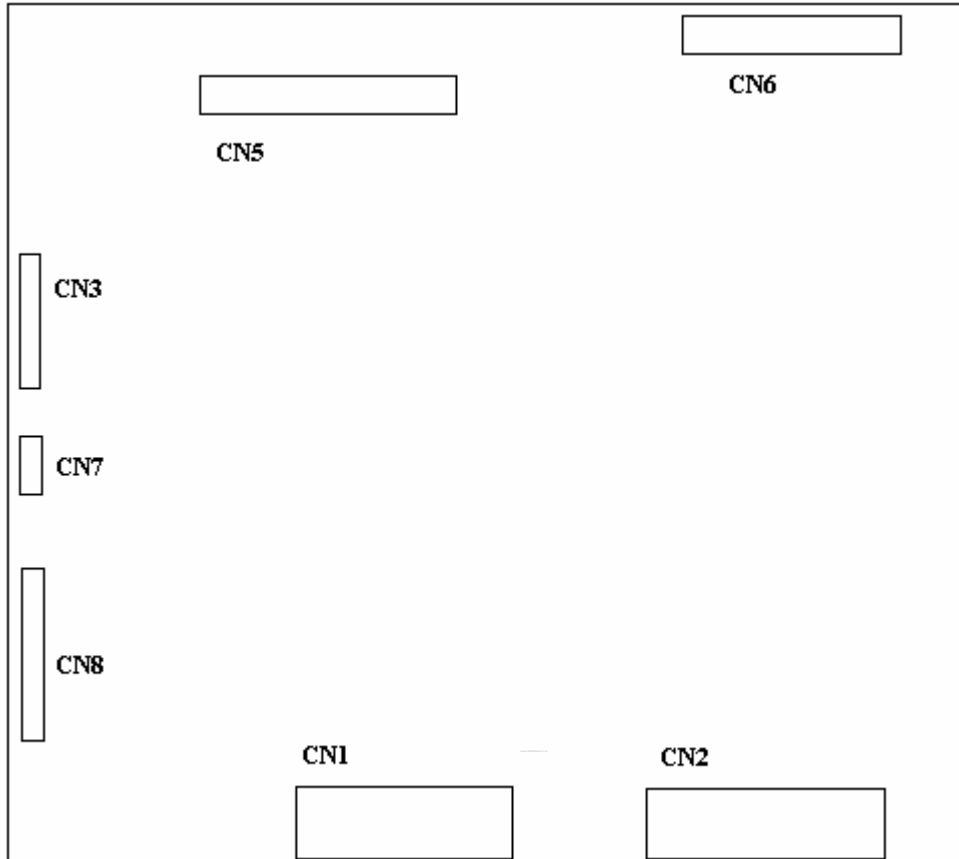

LABEL	Component	LABEL	Component
U1	24LC21A	CN1	D-SVB 15 PIN
U2	24LC21A	CN2	DVI-D 24 PIN
U3	TSU56AJ or TSU16AJ	CN3	E&T 96113-0803
U4	MX10E8050IAQC	CN5	P-TWO AFN300-N2G1Z 30P
U5	MAX810	CN6	E&T 4500-10
U6	24LC16B	CN7	E&T 4500-03
U7	APM4461	CN8	E&T 96113-1103
U8	APL1085-33CE		
U9	APL1117-1.8V		
U10	LM4838		

## 2.

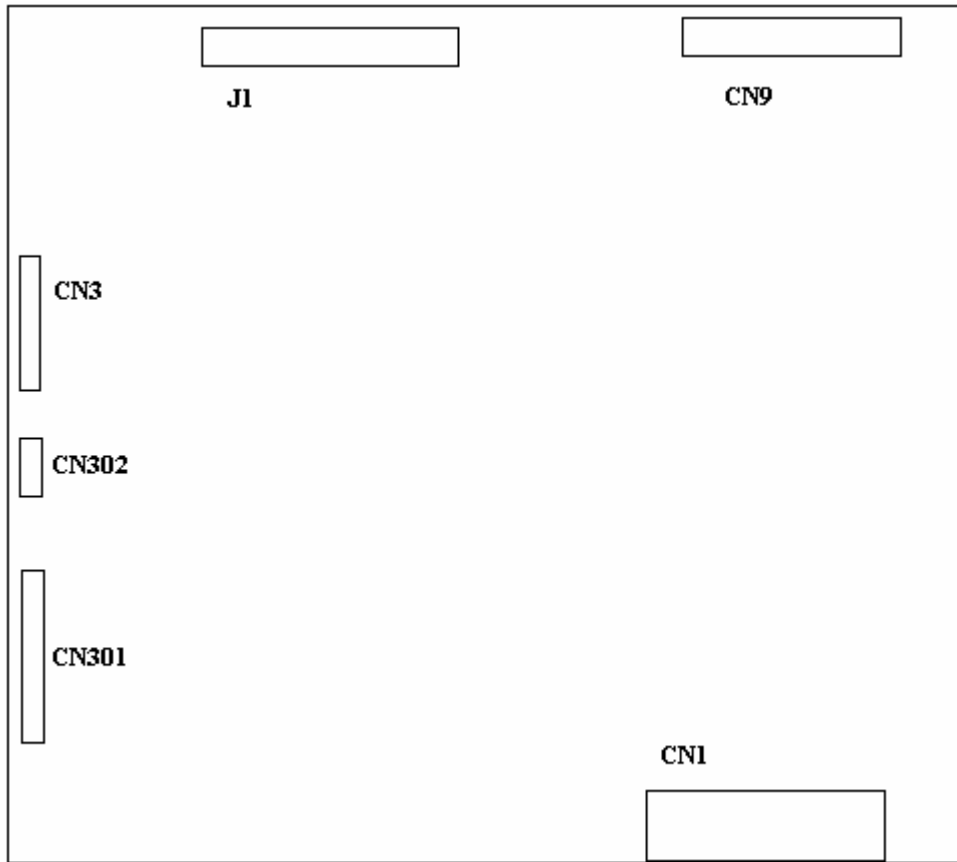

LABEL	Component	LABEL	Component
U3	SN74LVC14	CN1	D-SVB 15 PIN
U4	NT68F633	CN3	E&T 96113-0803
U5	24LC16B	CN9	E&T 4500-10
U6	NT68521	CN301	E&T 96113-1103
U10	APL1085-33CE	CN302	E&T 4500-03
U13	APL1117-2.5	J1	P-TWO AFN300-N2G1Z
U14	SI9435		
U501	LM4838		

# Software flow chart

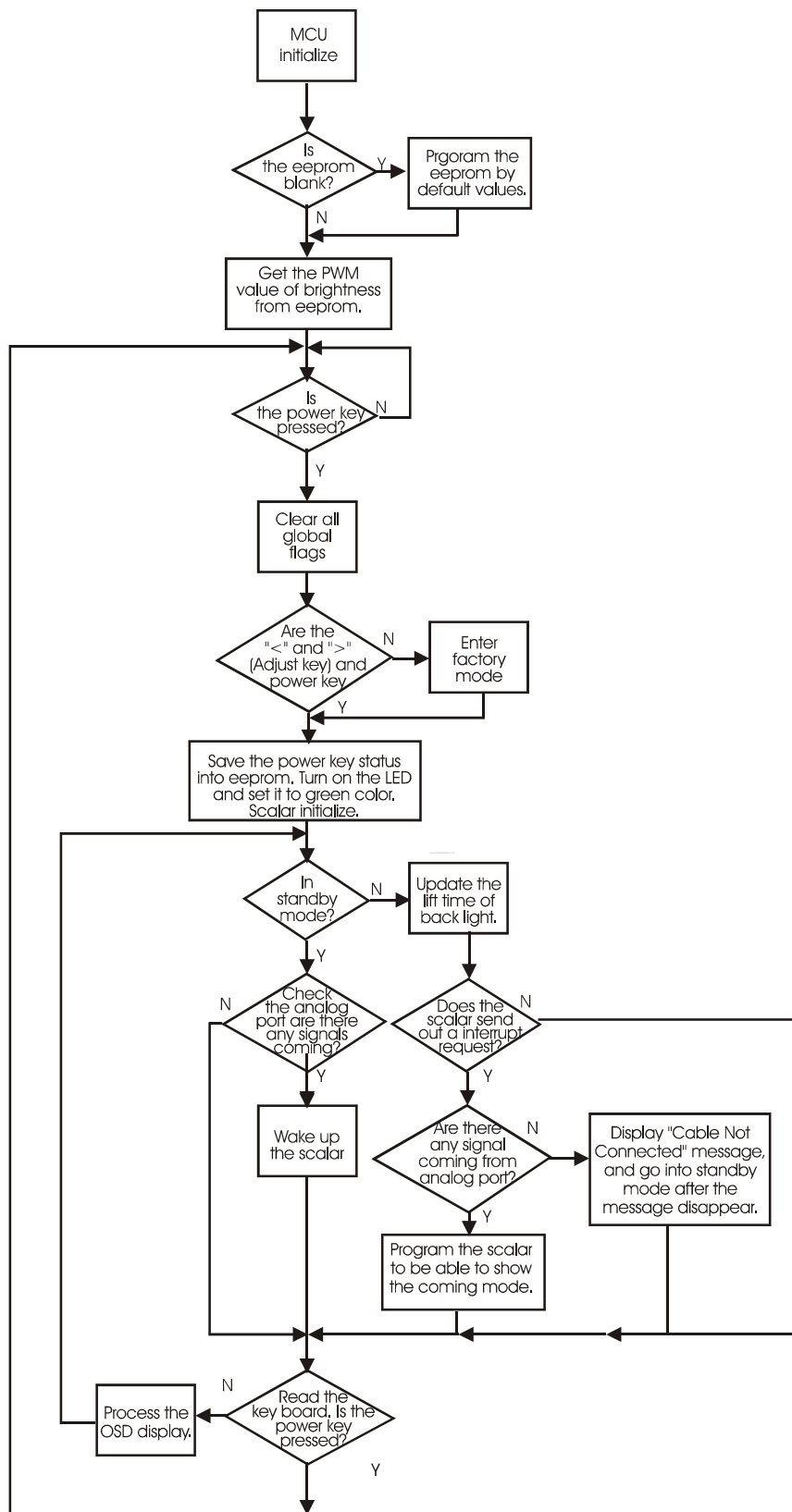

# General Instructions

Press the power button to turn the monitor on or off. The other control buttons are located at front panel of the monitor. By changing these settings, the picture can be adjusted to your personal preferences.

- The power cord should be connected.
- Connect the video cable from the monitor to the video card.
- Press the power button to turn on the monitor position. The power indicator will light up.

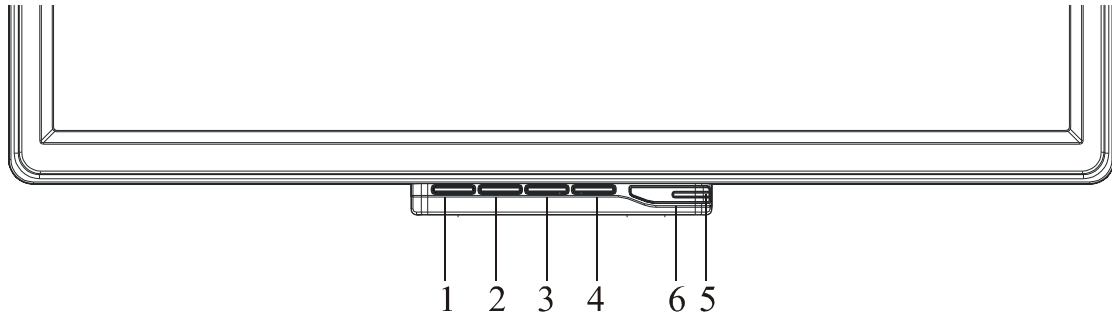

## External Controls

1	Auto Adjust Key/Exit	4	MENU/ENTER
2	<	5	LED
3	>	6	⏻ / Power Key

# System Installation

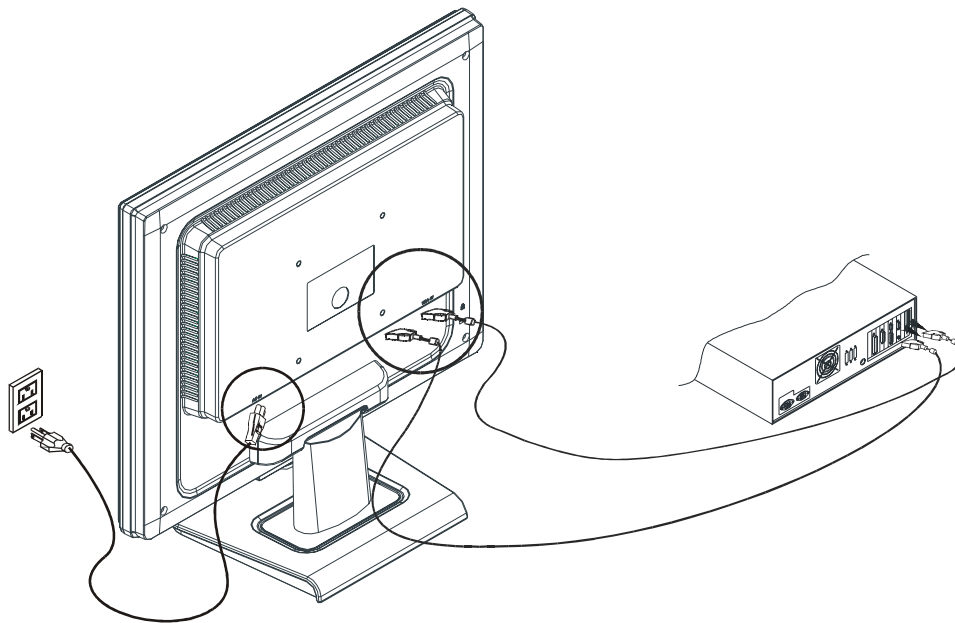

## Connecting the Display

- Power off your computer.
- Connect one end of the signal cable to the LCD Monitor's VGA port.
- Connect the other end of the signal cable to the VGA port on your PC.
- Make sure connections are secure.

## Connecting the AC Power

- Connect the power cord to the LCD Monitor.
- Connect the power cord to an AC power source.

## Gap Spec.

The step between front bezel and back cover shall be within specification.

Top and Bottom

Back cover & Bezel concavity

$0.8\text{mm} \leq A \leq 1.3 \text{ mm}$

Left and Right

Back cover & Bezel concavity

$0.8\text{mm} \leq A \leq 1.3 \text{ mm}$

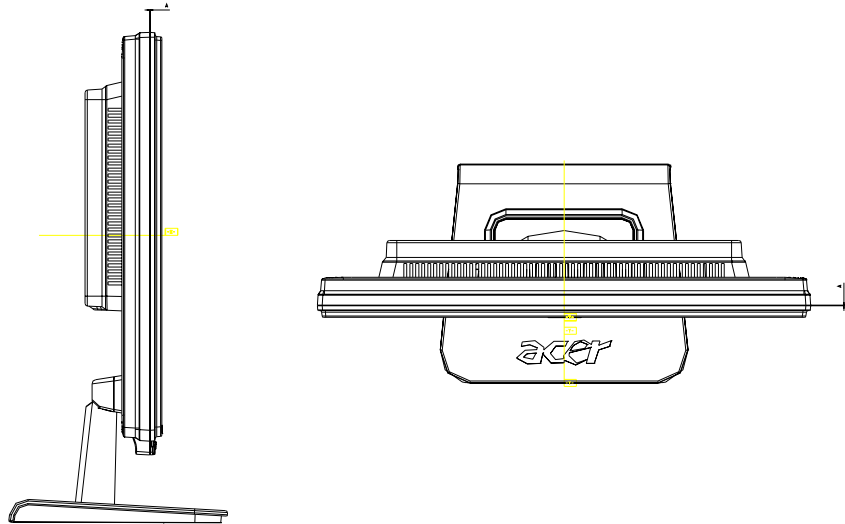

Back Cover & Hinge Cover concavity

$0\text{mm} \leq B \leq 0.5\text{mm}$

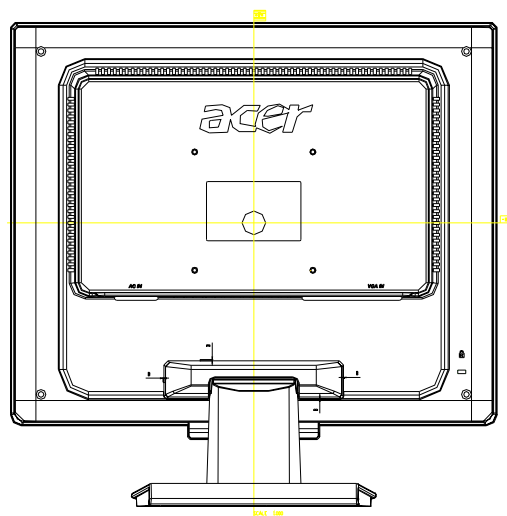

Base & Neck concavity

$$0\text{mm} \leq C \leq 0.6\text{mm}$$

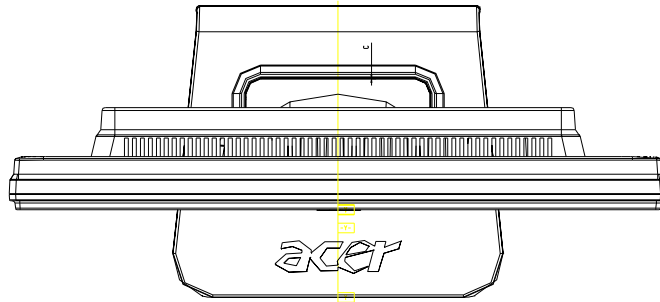

Top and Bottom

Back cover & Bezel step

$$0\text{mm} \leq D \leq 0.8 \text{ mm}$$

Left and Right

Back cover & Bezel step

$$0\text{mm} \leq D \leq 0.8 \text{ mm}$$

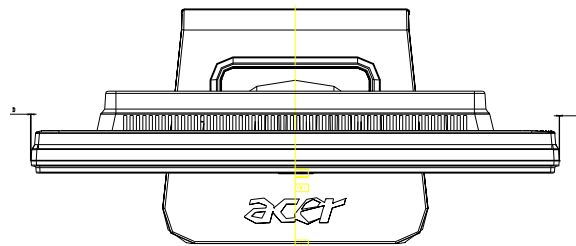
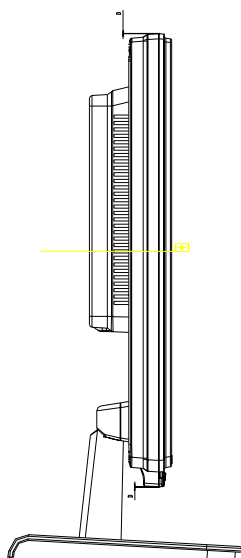

## LCD Horizontally

*The angle between front bezel and LCD unit in bottom side should not large than 1.0mm.*

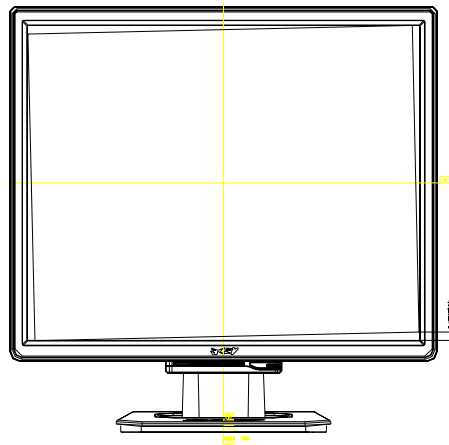

*The distance of the LCD display unit from left side to right should not large than 4.0mm.*

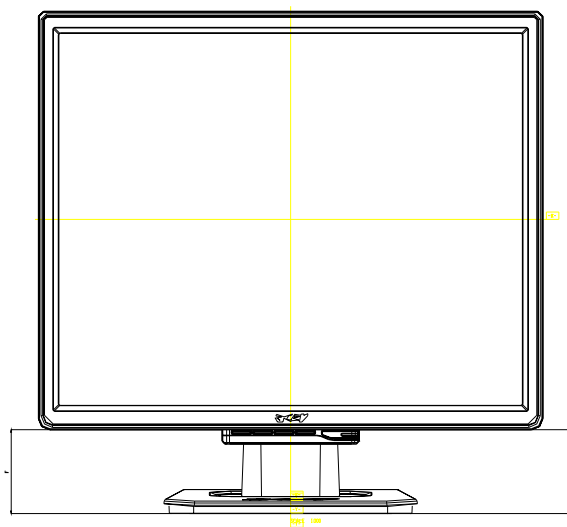



## Tilt Base Rotation

Tilt up  $15 \pm 2^\circ$  / down  $5 \pm 2^\circ$

## Plastic Material

For TCO99

Front Bezel PC+ABS

Back Cover PC+ABS

The Others ABS 94HB

For MPRII

Front Bezel ABS 94V-0

Back Cover ABS 94V-0

The Others ABS 94HB

## GAP Spec.

Gap between panel with bezel is  $0 \text{ mm} < \text{gap} < 1.5 \text{ mm}$

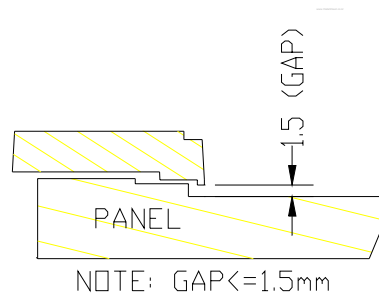

## Swivel title noise spec.

When adjust the monitor angle, the range should be limited  $-5^\circ \sim +15^\circ$  and it should not have any noise.

# POWER/Inverter Board

## Description

This specification defined the performance and characteristic of power/inverter board.

It supplies the following outputs :

- 1). 5Vdc: Logic power.
- 2). 5Vaudio: Audio power.
- 3). 15Vinv: Inverter power.

## Features

Input Voltage: 100 ~ 240  $\pm 10\%$  Vac

Input Frequency: 47 ~ 63Hz

Input power consumption: Less than 1.2W @ minimum load

Total output power: 55Wmax

Inverter brightness adjustment: Burst mode

Protection function: auto-recovery type

## Interface Signals

### Input

1. AC Inlet: HUAJIE SA-4S-066 or compatible.
2. J701: SC SCJ-0345-1-X-9 3.6D BLU 3P or compatible.

### Output Connector & Pin Assignment:

#### 1. The connector was pitch 2.0mm.

PIN NO.	Function	Function
1	+5Vaudio	Audio power (optional).
2	GND	Audio ground
3	GND	Ground
4	GND	Ground
5	Vbri	Brightness control from logical board (0V to 3.3V)
6	----	-----
7	Ven	Inverter enable signal from logical board (high active , >3V)
8	+5Vdc	+5Vdc supply for logical board
9	+5Vdc	+5Vdc supply for logical board
10	+5Vdc	+5Vdc supply for logical board

## 2. Inverter-side connector : SM02B-BHSS-1-TB(JST)

/ SM02(8.0)B-BHS-1(JST) or equivalent.

PIN NO.	Function	Comment
1	Cth	VBLH(High voltage)
2	Ctl	VBLL(Low voltage)

## Electrical Specification:

AC-DC Electrical specification

### 3.4.1.1 Input Specification

No	Item	Condition	Min.	Typ.	Max.	Unit
1	Input Voltage	-----	100	---	240	Vac
2	Input frequency	-----	47	---	63	Hz
3	Input Current	-----	---	---	1.0	Arms
4	Inrush Current	Cold Start @Vin=100Vrms	---	---	30	A0-P
		Cold Start @Vin=240Vrms	---	---	50	A0-P
5	Hold Up Time	@full load & 100Vac input	10	---	---	ms
6	Turn on time	Vin =110Vac	---	1.0	---	S
7	Efficiency	Full load	---	70	---	%
8	Consumption	Vin=240Vac,@ no load	---	---	1	W

### 3.4.1.2 AC-DC Output Specification

Output voltage	Tolerance	Output Current		Voltage Tolerance
		MIN	MAX	
+5Vdc	+5 /-3 %	0.05A	1.5A	4.85~5.25V dc
+15Vinv	+35/-5 %	0A	2A	20~14.3Vdc
+5Vaudio	±5%	0A	0.6A	4.75~5.25Vdc
Ripple	Measured at DC output terminals which are paralleled with a 10uf Ecap & 0.1uf Ceramic cap.	---	1%	+5Vdc:50mVp-p +15Vinv:150mVp-p
Noise	2.Band width is limited within 20MHz	---	3%	+5Vdc:150mVp-p +15Vinv:450mVp-p
Dynamic Load Regulation	50~100% or 100~50% load change of any DC output @50% duty of	---	±5%	---
Over / Under	@ Power line on/off	---	±5%	---

\*+5Vdc load regulation test: the +15Vinv loading at 2.0A

\*+15Vinv load regulation test: the +5Vdc loading at 1.5A

### 3.4.1.3 Protection function

- 1) SCP: Short circuit protection must be acted on both outputs
- 2) OPP: Should be protected when output power consumption is within 60W ~ 75W

Inverter Electrical Specification:

For Samsung LTM190EX

	Condition	Min.	Typ.	Max.	Unit
Input Voltage	---	---	15	---	V
Input Current	---	---	1.5	---	A
Backlight ON/OFF Control	ON		3.3		V
	OFF		0		V
Brightness Adjust	Min. Luminance / Max. Luminance	---	30%	---	---
Output Voltage	Vin=15V, Iout=7.5mA		650		Vrms
Brightness	lamp current in 7.5mA	250	300	---	Cd/m <sup>2</sup>
Output Current(Each connector)	Vbri=0.4V~3.3V	4	7.5	8	mA
Frequency	---	40	---	60	KHz
Lamp start voltage	@0°C	1650	---	---	Vrms

Striking Time	---	---	1	---	S
Lamp Current Balance	---	---	±0.35	---	mA
Efficiency	Vin=15V	---	80	---	%
Operating Life Time	---	50000	---	---	Hr

\*.The open lamp voltage is testes at output connector terminal

## SAFETY

Leakage Current: 0.25mA @ 100Vac

Insulation Resistance: more than 3M ohms while withstanding a voltage of 500Vac

Hi-Pot: 3Kvac with using 3mA cut off current

# Power Consumption

The monitor is equipped with a power-management according to the below.

There is a delay of 5s ... 7s before the transition from On-state to any power saving state to avoid unintentionally entering of a power saving stage during display resolution and timing mode changes.

Transition from any power saving state to another can be instantaneous.

The recovery from Off-state requires no manual power on.

Mode	H-Sync.	V-Sync.	Video	Pw-cons.	Indicator	Rec. time*
Power-On	on	on	active	< 60W	Green LED	--
Power-off	off	off	blanked	< 3 W	Orange LED	< 5S
Switch-off				< 3 W	Dark LED	

SYNC. On means: Normal operation

SYNC. Off means:                   H sync. F < 10KHz duty cycle > 25%  
   V sync. F < 10Hz     duty cycle > 25%

# CONNECTORS / CONTROLS

## Connectors

- Power : Monitor rear side : AC Inlet
- Analog RGB : Monitor rear side / Data Cable : 15-pin D-sub female / male

Pin – Assignment of 15-pin D-sub:

1	Red Video	9	+5V FOR DDC
2	Green Video	10	Detect
3	Blue Video	11	Serial Data for ISP
4	Serial Clock for ISP	12	Serial Data for DDC
5	Ground	13	H-Sync.
6	Red Ground	14	V-Sync.
7	Green Ground	15	Serial Clock for DDC
8	Blue Ground		

- Audio : Monitor rear side :  
   -PC I/P for PC : 3.5mm Stereo female

# Monitor Control Keys

KEY : Power , Menu , Adjust +/- , Vol +/-, Auto

# Position Of Controls

- Position of all switches : Bottom side of front bezel
- Position of LED : Bottom side of front bezel

# Chapter 2

## Operating Instructions

---

### CONTROLS

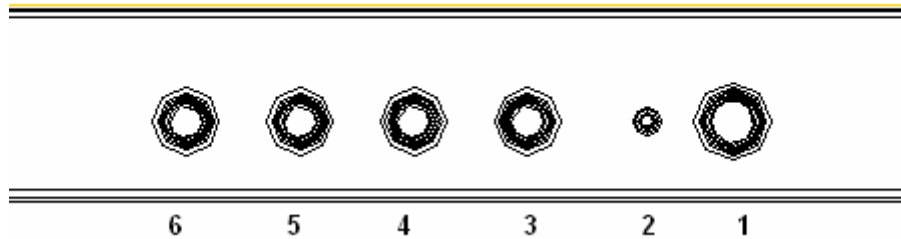

#### Control panel (monitor front panel)

1. Power ON/OFF switch, push to ON and push to OFF. (toggle switch)
2. Power LED, will be green when monitor is on; be amber when in power saving mode.
3. Function select.
4. Adjust increase.
5. Adjust decrease.
6. Auto adjust.

## Main OSD Menu:

### Outline:

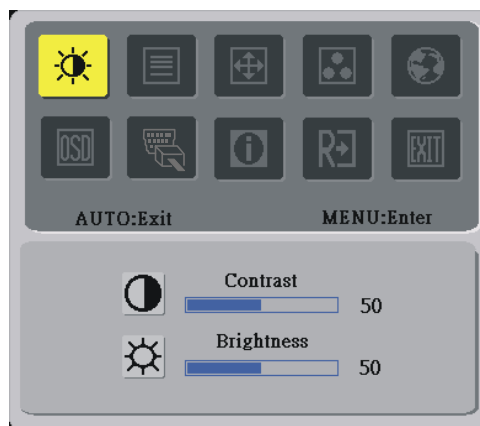











(option)

### The description for control function :

Main Menu Icon	Sub Menu Item	Sub Menu Icon	Description	Adjustment Range	Reset Value
	Contrast		Contrast from Digital-register.	0-100	Recall Cool Contrast Value
	Brightness		Backlight Adjustment	0-100	Recall Cool Brightness Value
	Focus		Adjust Picture Phase to reduce Horizontal-Line noise	0-100	Do Auto Config
	Clock		Adjust picture Clock to reduce Vertical-Line noise.	0-100	Do Auto Config
	H. Position		Adjust the horizontal position of the picture.	0-100	Do Auto Config
	V. Position		Adjust the vertical position of the picture.	0-100	Do Auto Config
	Warm	N/A	Recall Warm Color Temperature from EEPROM.	N/A	The Color Temperature will be set to Cool.
	Cool	N/A	Recall Cool Color Temperature from EEPROM.	N/A	
	User / Red		Red Gain from Digital-register.	0-100	100
	User / Green		Green Gain Digital-register.	0-100	100
	User / Blue		Blue Gain from Digital-register.	0-100	100



	English	N/A	Set OSD display language to English.	N/A	The Language will be set to English.
	繁體中文	N/A	Set OSD display language to Traditional Chinese.	N/A	
	Deutsch	N/A	Set OSD display language to German.	N/A	
	Français	N/A	Set OSD display language to French.	N/A	
	Español	N/A	Set OSD display language to Spain.	N/A	
	Italiano	N/A	Set OSD display language to Italian.	N/A	
	简体中文	N/A	Set OSD display language to Simplified Chinese.	N/A	
	日本語	N/A	Set OSD display language to Japanese.	N/A	
	H. Position		Adjust the horizontal position of the OSD.	0-100	50
	V. Position		Adjust the vertical position of the OSD.	0-100	50
	OSD Timeout		Adjust the OSD timeout.	10-120	10
	Auto Config	N/A	Auto Adjust the H/V Position, Focus and Clock of picture.	N/A	N/A
	N/A	Source Change	Analog and Digital source change.(option)	N/A	N/A
	Information	N/A	Show the resolution, H/V frequency and input port of current input timing.	N/A	N/A
	Reset	N/A	Clear each old status of Auto-configuration and set the color temperature to Cool.	N/A	N/A
	Exit	N/A	Exit OSD	N/A	N/A

## OSD Message:

### Outline:



### The description for OSD Message :

Item	Description
Auto Config Please Wait	When User Press Hot-Key "Auto", will show this message, and the monitor do the auto config function.
Input Not Supported	When the Hsync Frequency, Vsync Frequency or Resolution is out of the monitor support range, will show this message. This message will be flying.
Cable Not Connected	When the video cable is not connected, will show this message. This message will be flying.
No Signal	When the video cable is connected, but there is no active signal input, will show this message, then enter power saving.

## LOGO:

When the monitor is power on, the LOGO will be showed in the center.



## Item of Factory menu

Vendor may customize design and add adjustment items Factory menu as far as all required items are included.

### **1) Bright**

Adjust Brightness and Contrast value to Max.

### **2) Auto Balance**

Adjust each R, G, B contrast (gain) and offset.

Method of auto adjust is depends on hardware.

Adjusted value of R, G, B gain shall be used for initial value of Contrast in user menu.

All value shall be adjustable manually.

This function shall be located in 3. tag of Factory menu.

### **3) Factory color temp data edit**

Following data for color temp shall be editable manually.

-color temp default preset No.

## Plug and play

### Plug & play DDC2B feature

This monitor is equipped with VESA DDC2B capabilities according to the VESA DDC STANDARD. It allows the monitor to inform the host system of its identity and, depending on the level of DDC used, communicate additional information about its display capabilities. The communication channel is defined in two levels, DDC2B.

The DDC2B is a bidirectional data channel based on the I<sup>2</sup>C protocol. The host can request EDID information over the DDC2B channel.

**THIS MONITOR WILL APPEAR TO BE NON-FUNCTIONAL IF THERE IS NO VIDEO INPUT SIGNAL. IN ORDER FOR THIS MONITOR TO OPERATE PROPERLY, THERE MUST BE A VIDEO INPUT SIGNAL.**

This monitor meets the Green monitor standards as set by the Video Electronics Standards Association (VESA) and/or the United States Environmental Protection Agency (EPA) and The Swedish Confederation Employees (NUTEK). This feature is designed to conserve electrical energy by reducing power consumption when there is no video-input signal present. When there is no video input signal this monitor, following a time-out period, will automatically switch to an OFF mode. This reduces the monitor's internal power supply consumption. After the video input signal is restored, full power is restored and the display is automatically redrawn. The appearance is similar to a "Screen Saver" feature except the display is completely off. The display is restored by pressing a key on the keyboard, or clicking the mouse.

### Using The Right Power Cord

The accessory power cord for the Northern American region is the wallet plug with NEMA 5-15 style and is UL listed and CSA labeled. The voltage rating for the power cord shall be 125 volt AC.

Supplied with units intended for connection to power outlet of personal computer: Please use a cord set consisting of a minimum No. 18 AWG, type SJT or SVT three conductors flexible cord. One end terminates with a grounding type attachment plug, rated 10A, 250V, CEE-22 male configuration. The other end terminates with a molded-on type connector body, rated 10A, 250V, having standard CEE-22 female configuration.

Please note that power supply card needs to use VDE 0602, 0625, 0821 approval power cord in European countries.

## White Color Temperature

White color temperature is 4 preset as 9300, 7500,6500 and User,  
 Default value of user color should be user which is maximum setting for panel.

Target of color setting

Color Temp.	Color Coordinate		Tolerance	Color Coordinate		Tolerance
	x	y		u'	v'	
9300K	0.283	0.297	$\pm 0.03$	0.189	0.446	$u'v' \leq 0.01^*$
6500K	0.313	0.329	$\pm 0.03$	0.198	0.469	$u'v' \leq 0.01^*$
User	-	-		-	-	-

\*) TCO'0X A.2.6.1 requirement

User should follow "Microsoft Windows Color Quality Specification for Liquid Crystal Display OEM's".  
 (<http://www.microsoft.com/hwdev/tech/color/ColorTest.asp>)

## Audio Technical specification

### General Description:

Output power	: 1W + 1W maximum
Total harmonic distortion	: Less than 1 % (except speakers distortion)
Input signal sensitivity	: 0.5 Vrms for full output
Input impedance	: 47 Kohm +/- 5 %
Frequency response range	: 20Hz – 20kHz (except speakers response)
Difference of L and R output	: Less than 2 dB

## Electrical characteristics (Tamb=25°)

Audio amplifier(USE Panasonic VP-7723A Audio Analyzer. )

Item	Audio Input	Freq.	Spec.			Comment
			Min.	Typ.	Max.	
Input Voltage(V)			-	0.5Vrms	-	
Input Current(m A)			-	500	800	
Audio Voltage Gain	500m Vrms	1KHz	-	-	6 d B	Volume Max.,load 4 Ω
Frequency Response	500m Vrms	300Hz-20KHz	-10dB	-	+10d B	Volume Max.,load 4 Ω
Signal to Noise ratio	500m Vrms	1KHz	-	-	-40dB	Volume Max.,load 4 Ω
Total harmonic distortion	500m Vrms	1KHz			1%	except speakers distortion
Cross talk	500m Vrms	1KHz	-	-	-30dB	Volume Max.,load 4 Ω
Output Watt.	500m Vrms	1KHz	-	-	0.5W	Volume Max.,load 4 Ω
Volume Control			-	-	-	Analog

## Machine Disassembly and Replacement

---

### Disassembly Procedure

#### Disassemble the base

1. Remove the neck cover.
2. Remove the four screws to release the hinge.
3. Remove the base

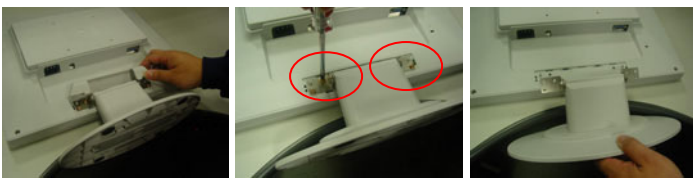

#### Disassemble the chassis

1. Remove the four screws to release the back cover.
2. Remove the two screws to release the EMI cover from chassis.
3. Remove the two screws from VGA connector.
4. Then take the chassis.
5. Remove the two screws from bezel.
6. To separate the chassis and bezel.
7. Remove the four screws from chassis and release the panel.

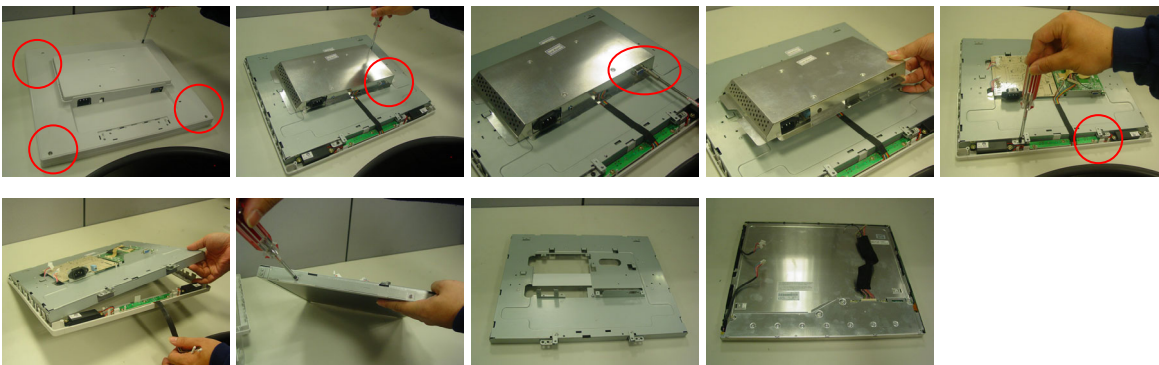

## Disassemble the main board

1. Disassemble audio line from power board.
2. Disassemble two VL-VK lines from VL board.
3. Disassemble power line from VL board.
4. Disassemble FPC line from VL board.
5. Remove the one screw to release line from Chassis.
6. Remove the three screws from Chassis and release the main board.

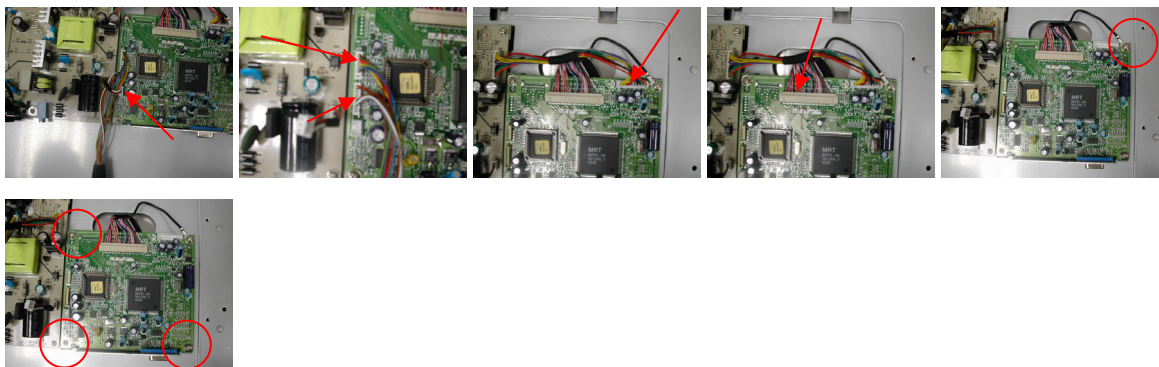

## Disassemble the power board

1. Disassemble two voltage lines from power board.
2. Remove the one screw to release line from Chassis.
3. Remove the three screws from Chassis.
4. Remove the two screws to release power board from Chassis.
5. Then take the power board from the chassis.

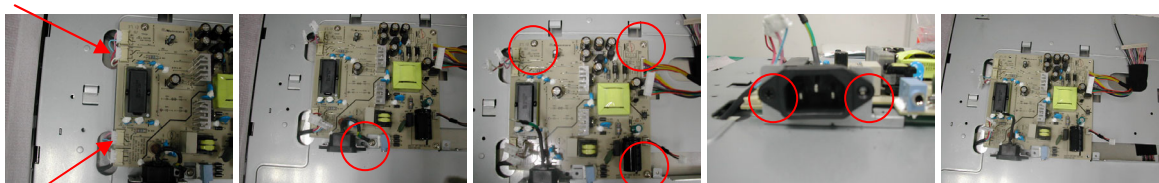

## Disassemble the key board

1. Remove the one screw to release VK board from bezel.
2. Disassemble the two speaker lines from VK board.





## Disassemble the speakers

1. Remove the two screws to release line and VK board from bezel.
2. Remove the two screws to release line and chassis from bezel.
3. Remove the four screws from bezel.

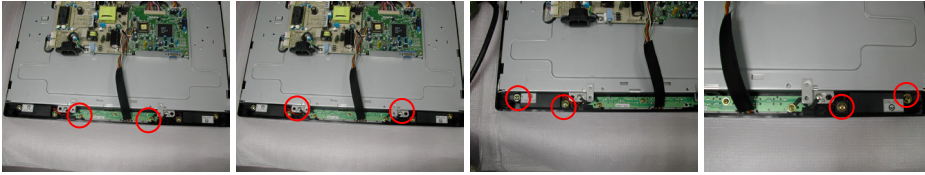

## Troubleshooting

### Main Procedure

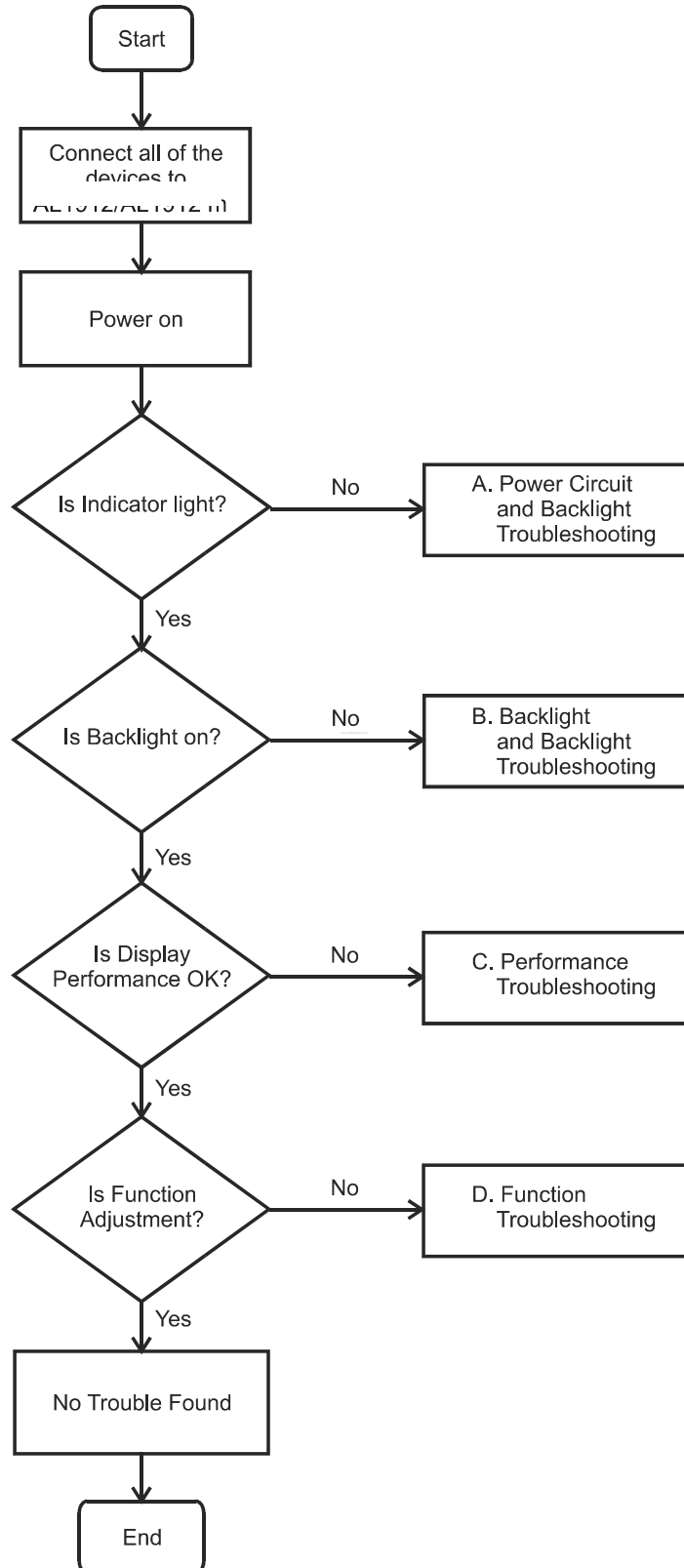

## Power Circuit and Backlights Troubleshooting

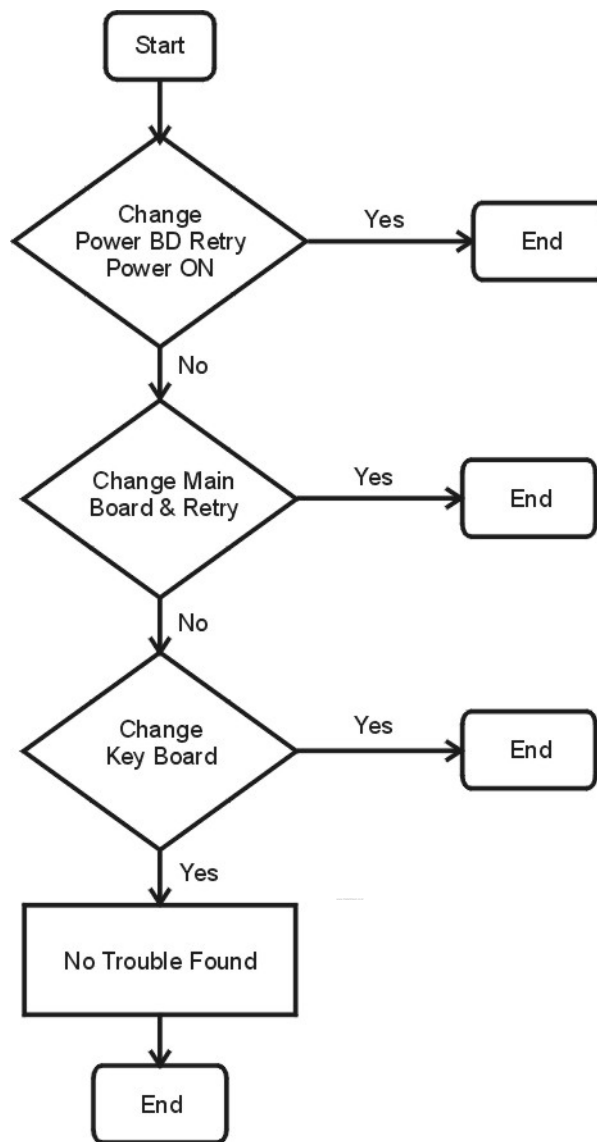

# Performance Troubleshooting

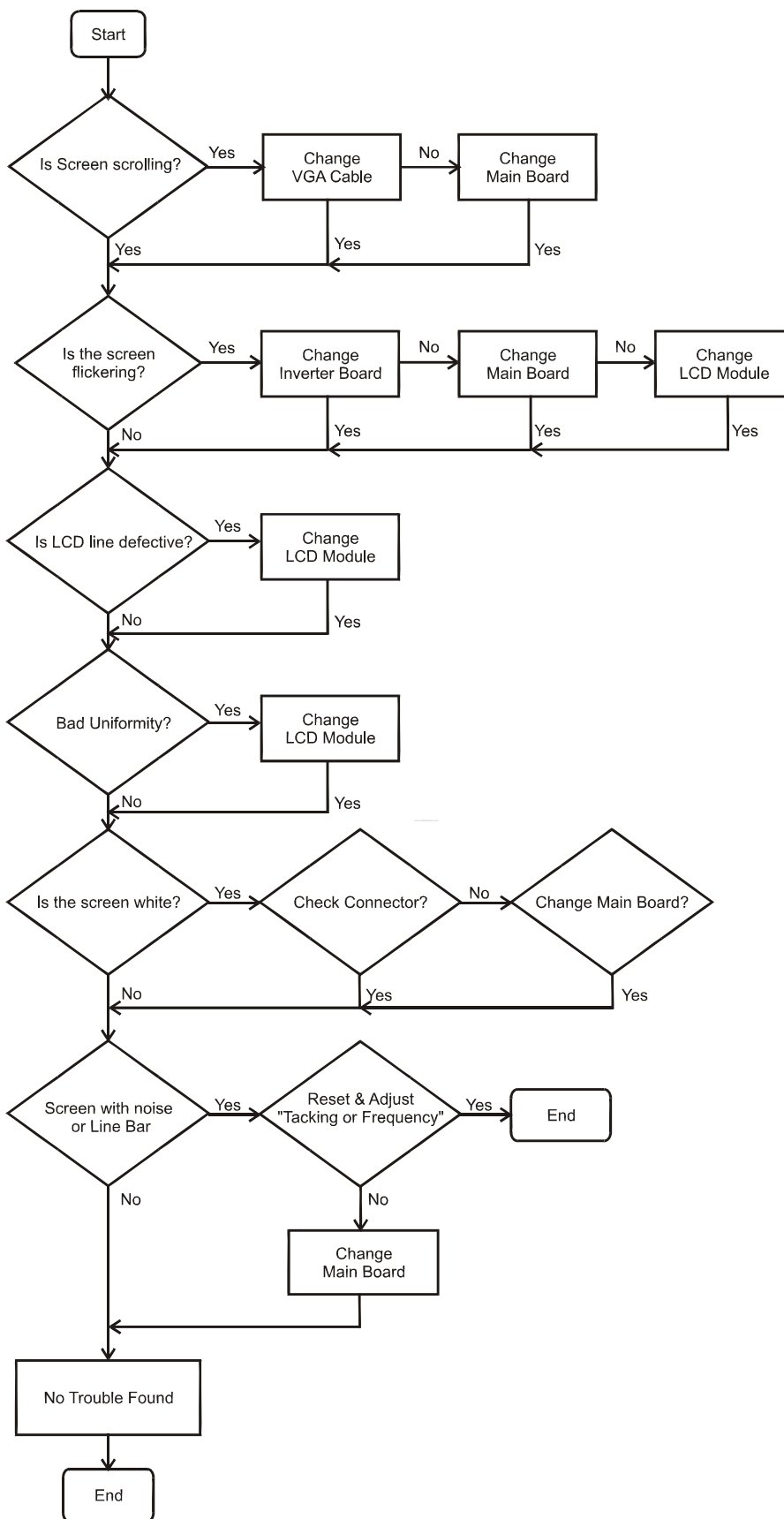

## Function Troubleshooting

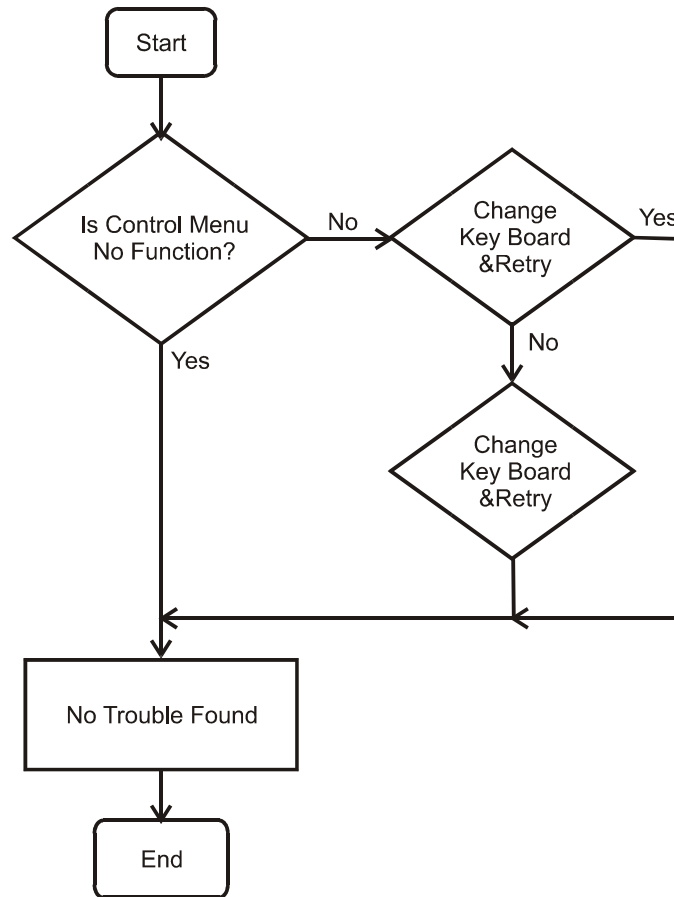

## Connector Information

### Phonejack stereo

PIN1. right : CEE22 typed connector

PIN2. Left

PIN3. Gnd : Line-in receptacle

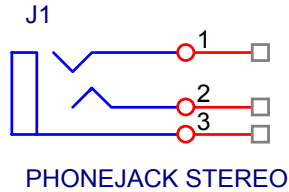

### Video input Connector

Analog Video input Connector: 15pins mini D-Sub

Table 2.4.5. Pin assignment for D-sub connector

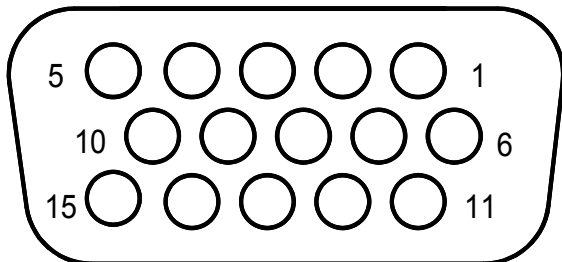

PIN NO.	Separate Sync
1	RED VIDEO
2	GREEN VIDEO
3	BLUE VIDEO
4	GROUND
5	GROUND
6	RED GROUND
7	GREEN GROUND
8	BLUE GROUND
9	PC5V (+5V DDC)
10	CABLE DETECTION
11	GROUND
12	SDA
13	H.SYNC
14	V.SYNC
15	SCL

## **FRU (Field Replaceable Unit) list**

---

This chapter gives you the FRU (Field Replaceable Unit) listing in global configurations of AL1916. Refer to this chapter whenever ordering for parts to repair or for RMA (Return Merchandise Authorization).

NOTE : Please note WHEN ORDERING FRU PARTS, that you should check the most up-to-date information available on your regional web or channel(<http://aicsl.acer.com.tw/spl/>). For whatever reasons a part number change is made, it will not be noted in the printed Service Guide. For ACER-AUTHORIZED SERVICE PROVIDERS, your Acer office may have a DIFFERENT part number code to those given in the FRU list of this printed Service Guide. You MUST use the local FRU list provided by your regional Acer office to order FRU parts repair and service of customer machines.

NOTE: To scrap or to return the defective parts, you should follow the local government ordinance or regulations on how best to dispose it, or follow the rules set by your regional Acer office on how to return it.

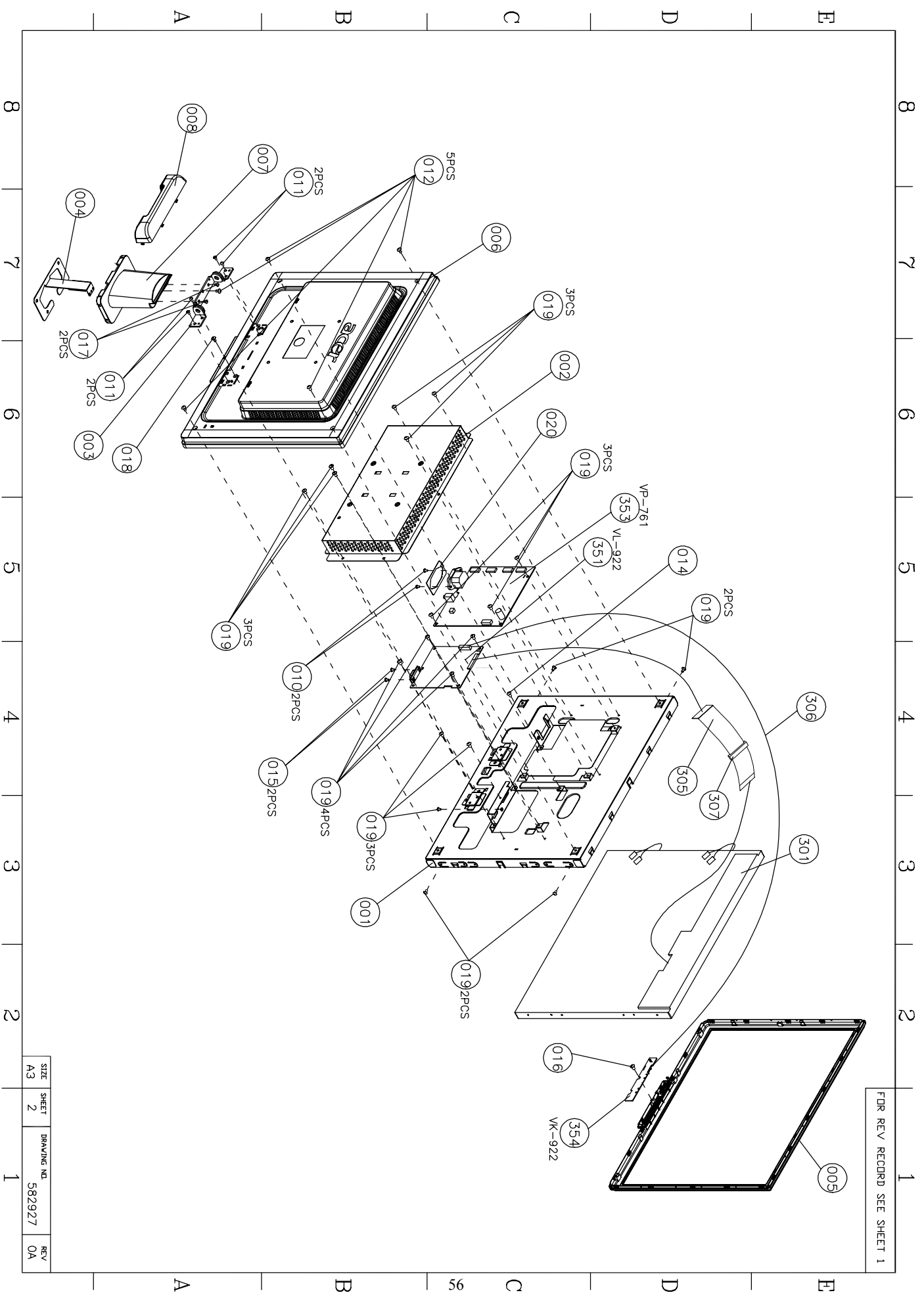



FOR REV RECORD SEE SHEET 1



SIZE	SHEET	DRAWING NO.	REV
A3	2	582927	0A

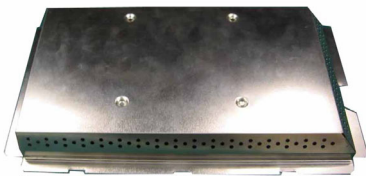
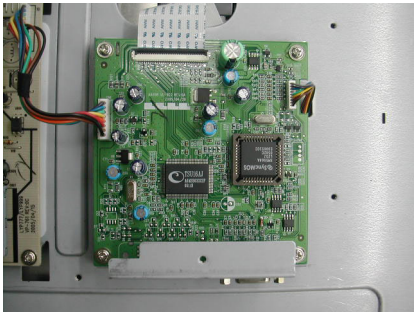
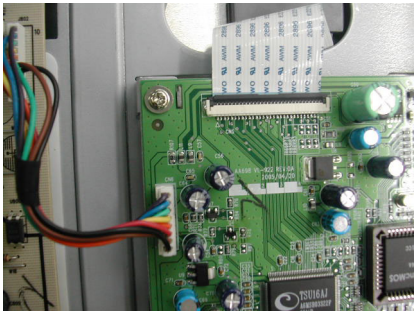
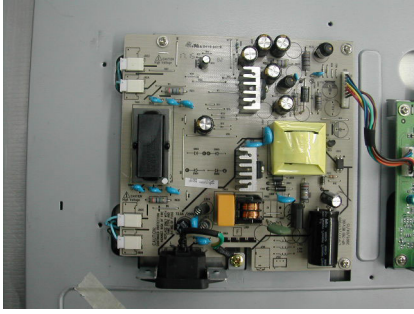

## Part list

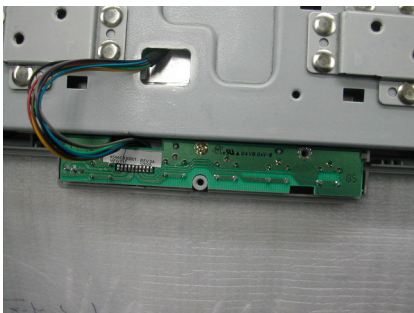
No.	Photo	Part Name	Part No.
1		Hinge Cover	FAAA6932000
2		Base Assy	FAAA691D000
3		Rear Cover	FAAA6914000
4		Base	FAAA691C000
6		Neck	FAAA6921000

7		Main Shield	ECAR9914A00
8		MB	AU:461ACQ30011 SAMSUNG:461ACQ30001
9		Power Board to MB cable	AU: 453AC530051 Samsung: 453AC530051
10		Inverter Board	AU: 453AC530051 Samsung: 453AC530051
11		Front Bezel	FAAA6911000
12		Keyboard to MB Cable	DCO20191700

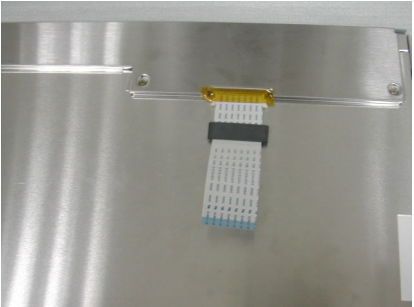
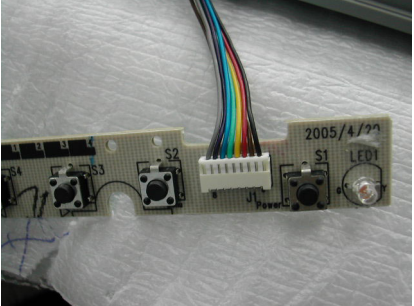
13		Frame	ECAR9915A00
14		LCD (R)	AC6VA1901R0 AC6VT1901R5
15		Panel to MB cable	NBX30001271 NBX30001600
16		Function Board	454AC830001

## Schematic Diagram

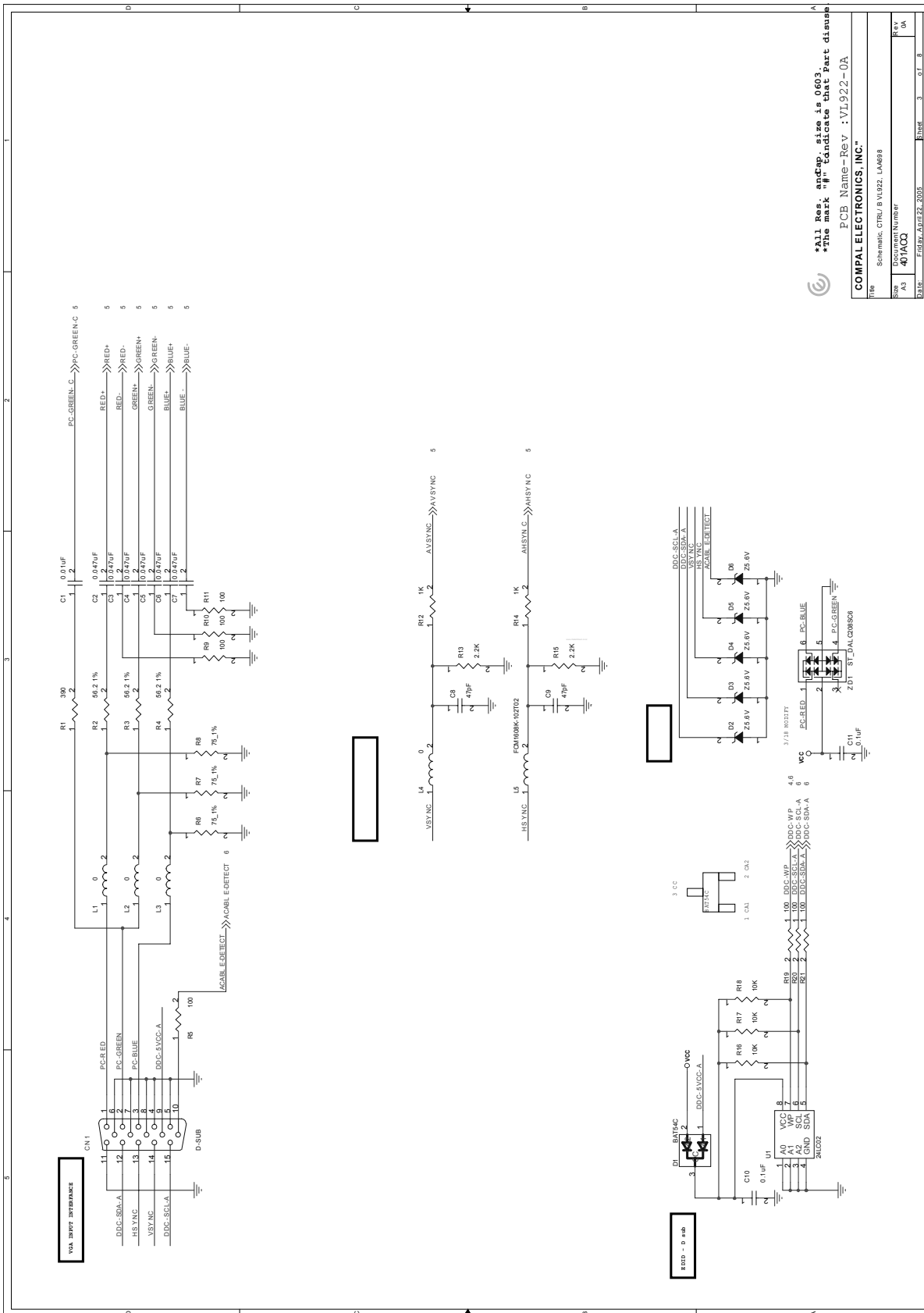

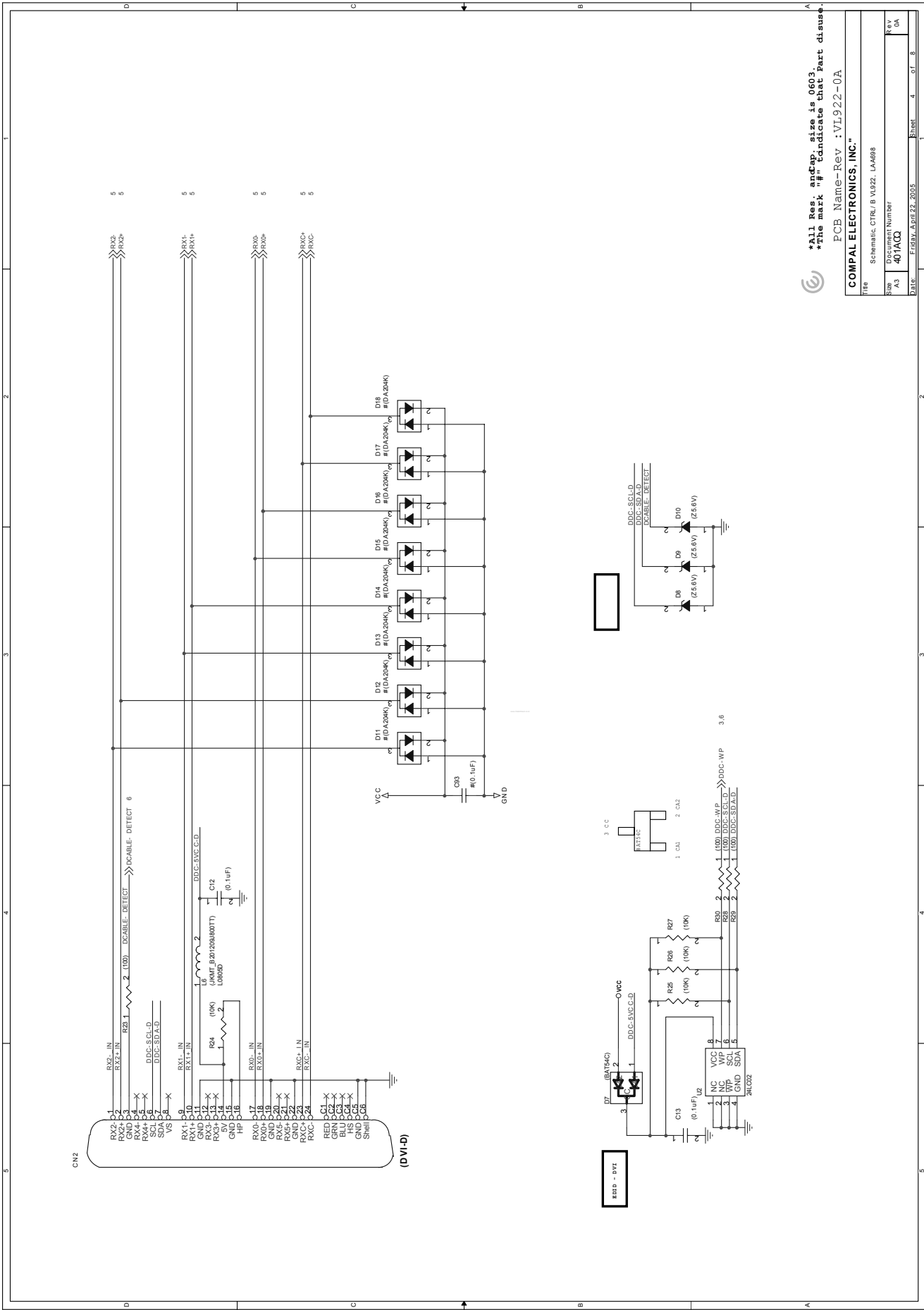

\*All Res. and Cap. size is 0603.  
 \*the mark "#" indicates that Part disuse.  
 PCB Name-Rev : VL922-0A

COMPAL ELECTRONICS, INC.	
Title	Schematic CTRL/B VL922 LA688
Size	Document Number
Part	401ACQ
Date	Friday, April 22, 2005
Sheet	4 of 8
Rev	0A

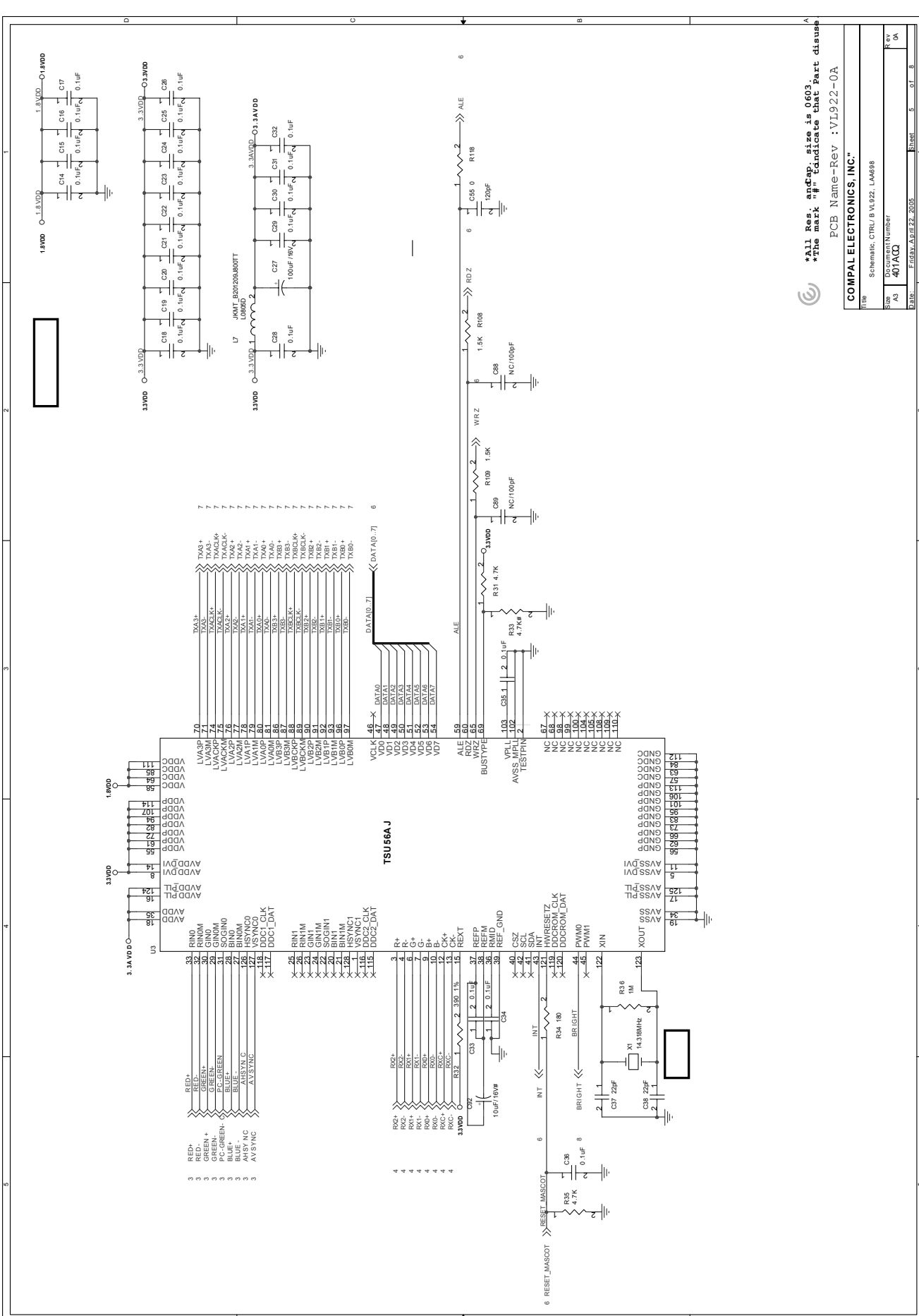

\*All Res. approp. is 0603  
\*The mask # is candidate chat Part disuse

PCB Name-Rev : VL922-0A

Title	Schematic, CTRLU/B VL922, LAA688
Size	Document Number
7A	401ACQ
File	FILEM_APL922_0005
Sheet	5 of 8

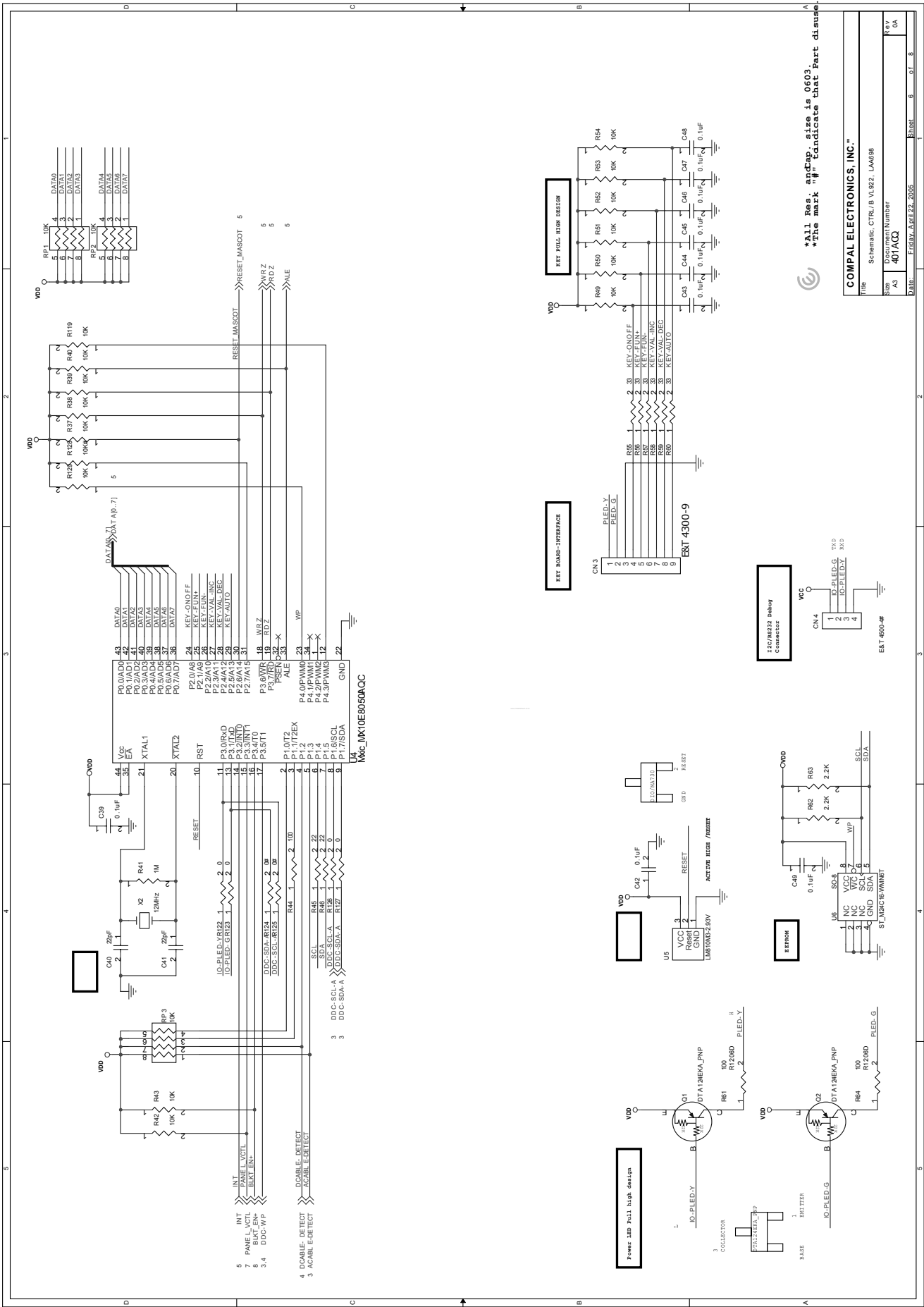

\*All Res. values are in Ohms unless otherwise specified.  
 \*The mark # in candidate chat Part disambiguation

COMPAL ELECTRONICS, INC.	
Title	Schematic: CTRL/B V1.022_LAM88
Size	Document Number
Part	REV. 0
Sheet	6 of 8

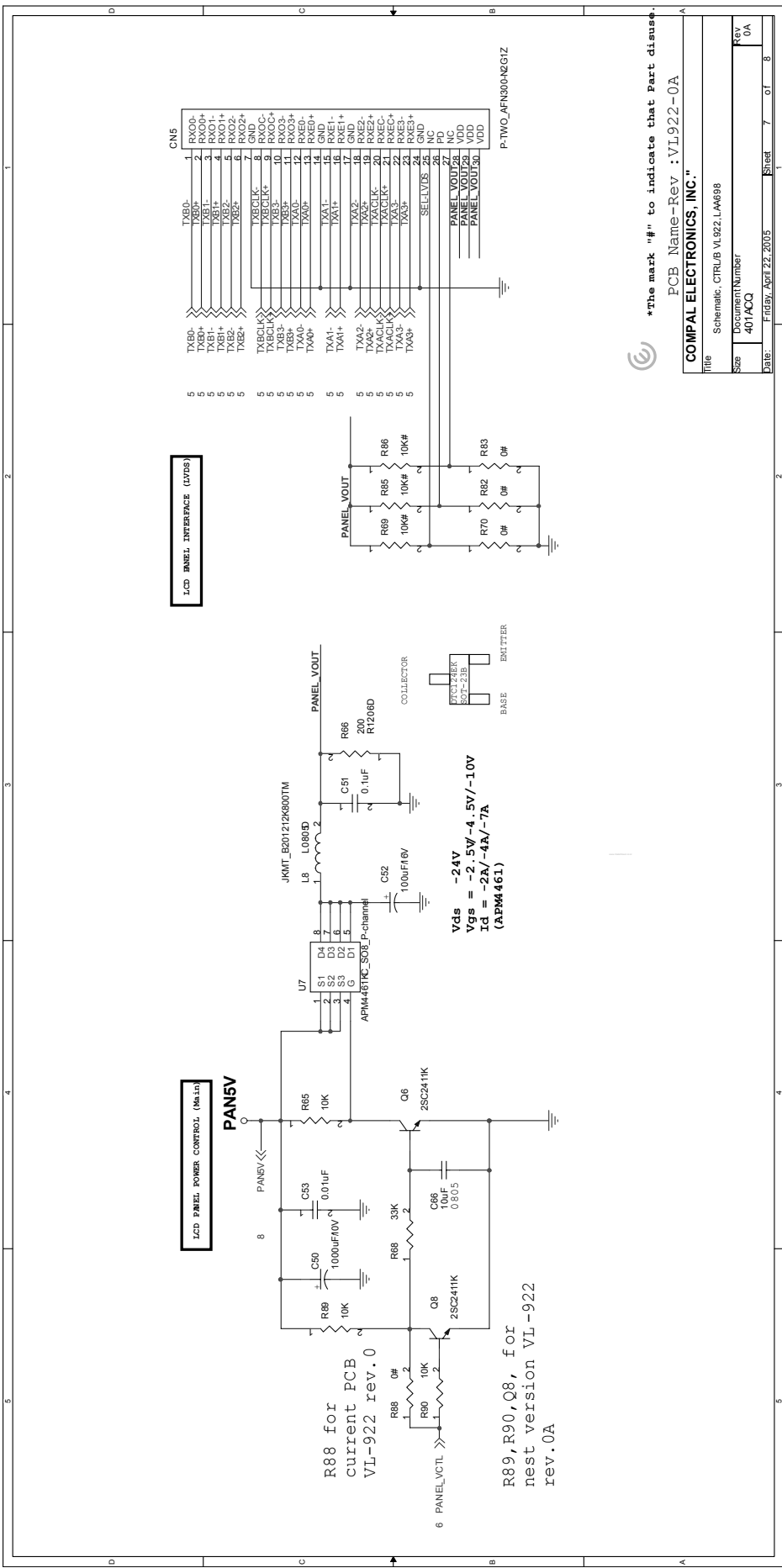

\*The mark "#" to indicate that Part disuse.

COMPAL ELECTRONICS, INC.

Title Schematic, CTRLUB VL922.LA698

Size Document Number 401PACQ

Date Friday, April 22, 2005

Sheet 7 of 8



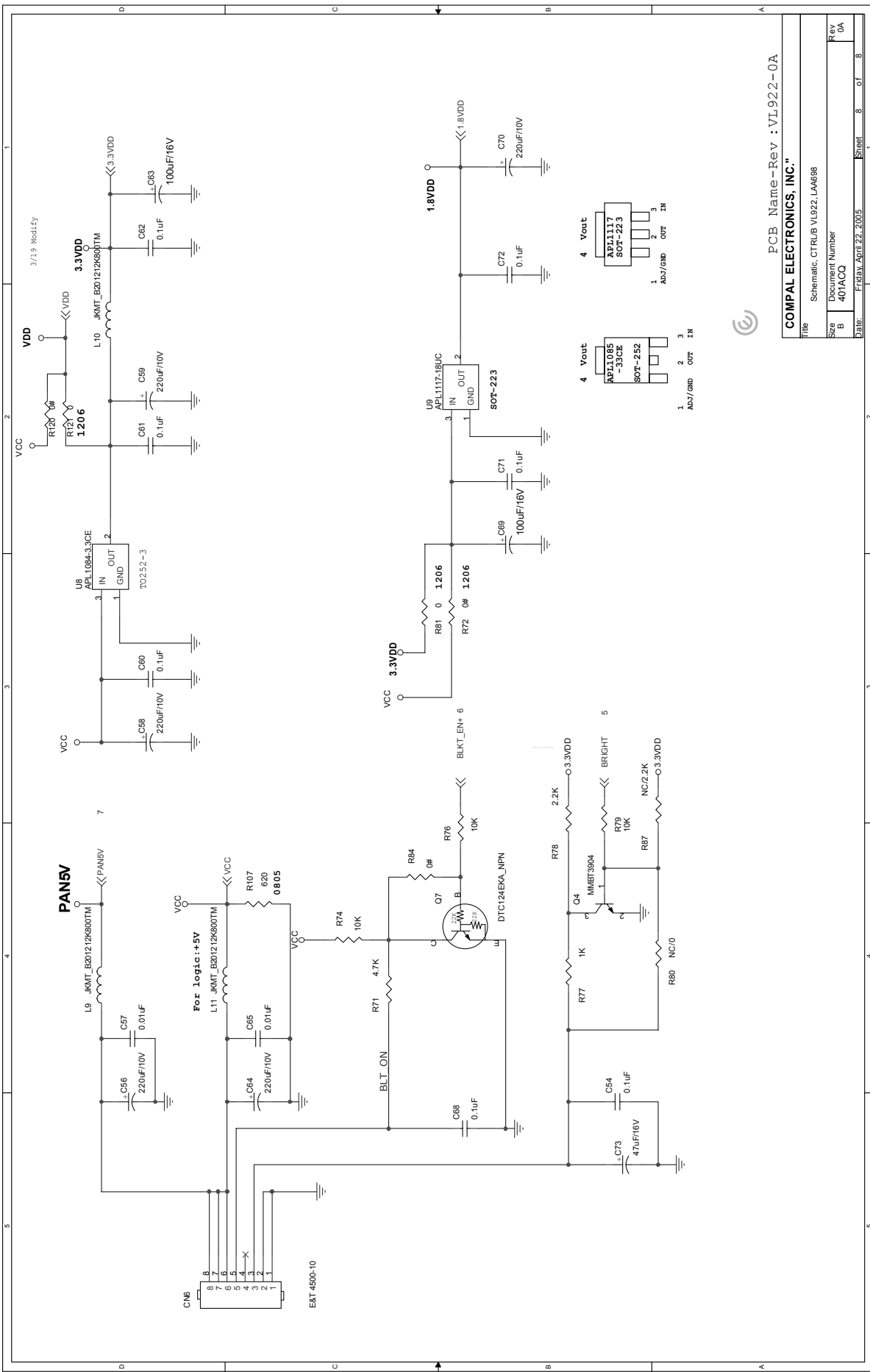

PCB Name-Rev : VI922-0A

Title	Schematic, CTRLUB VL922_LAA688
Size	Document Number
B	407ACQ
Date	Friday, April 22, 2005
Sheet	8 of 8
Rev	0A

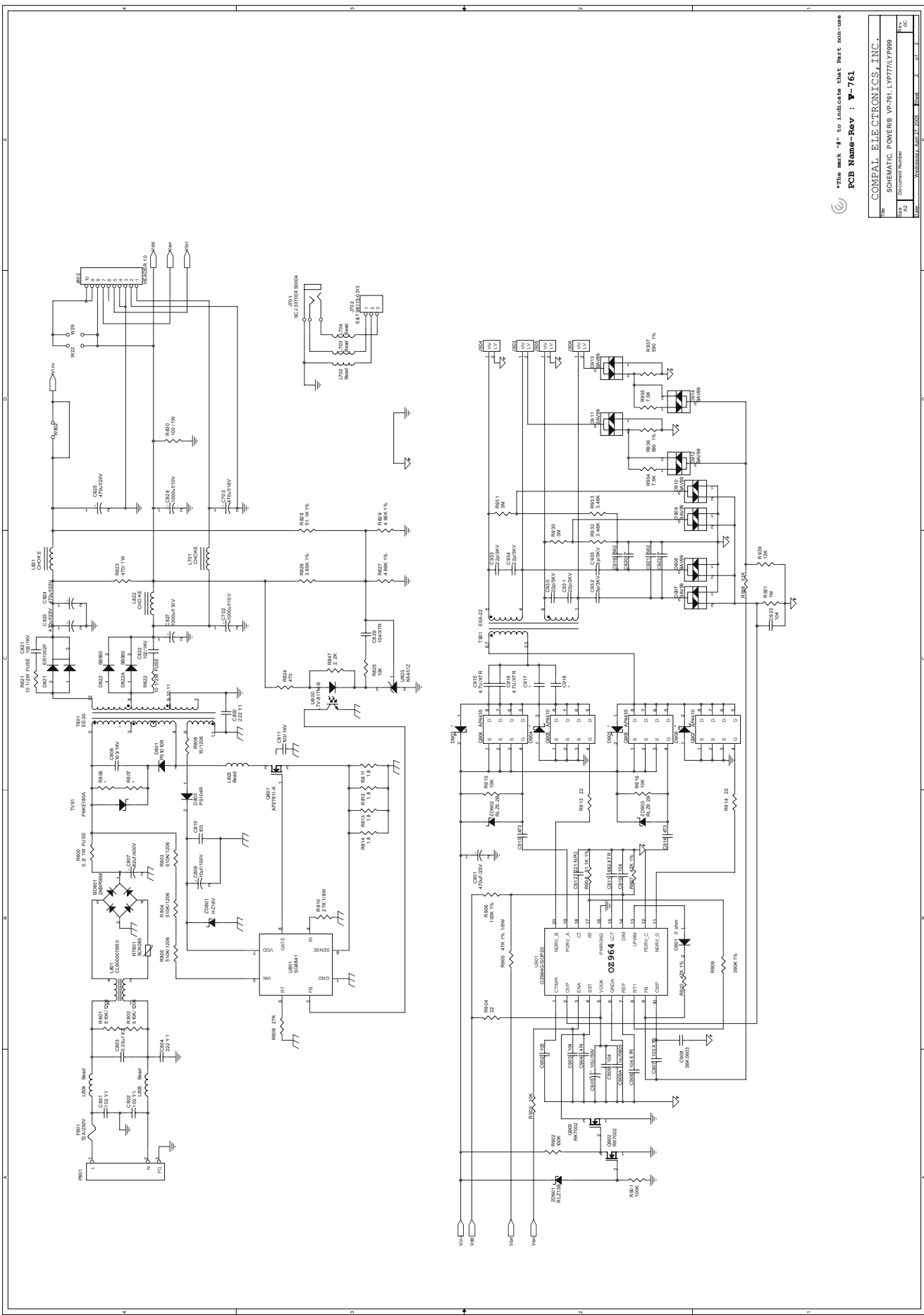

\*The mark #\* to indicate that part non-use  
**PCB Name-Rev : P-761.**

COMPAL ELECTRONICS, INC.	
REV	SCHEMATIC: POWERB VP-961, LYPT77LYP99
DATE	Docuement Number
DATE	DATE: 01/27/2005
REV	REV: 2
DATE	DATE: 01/27/2005

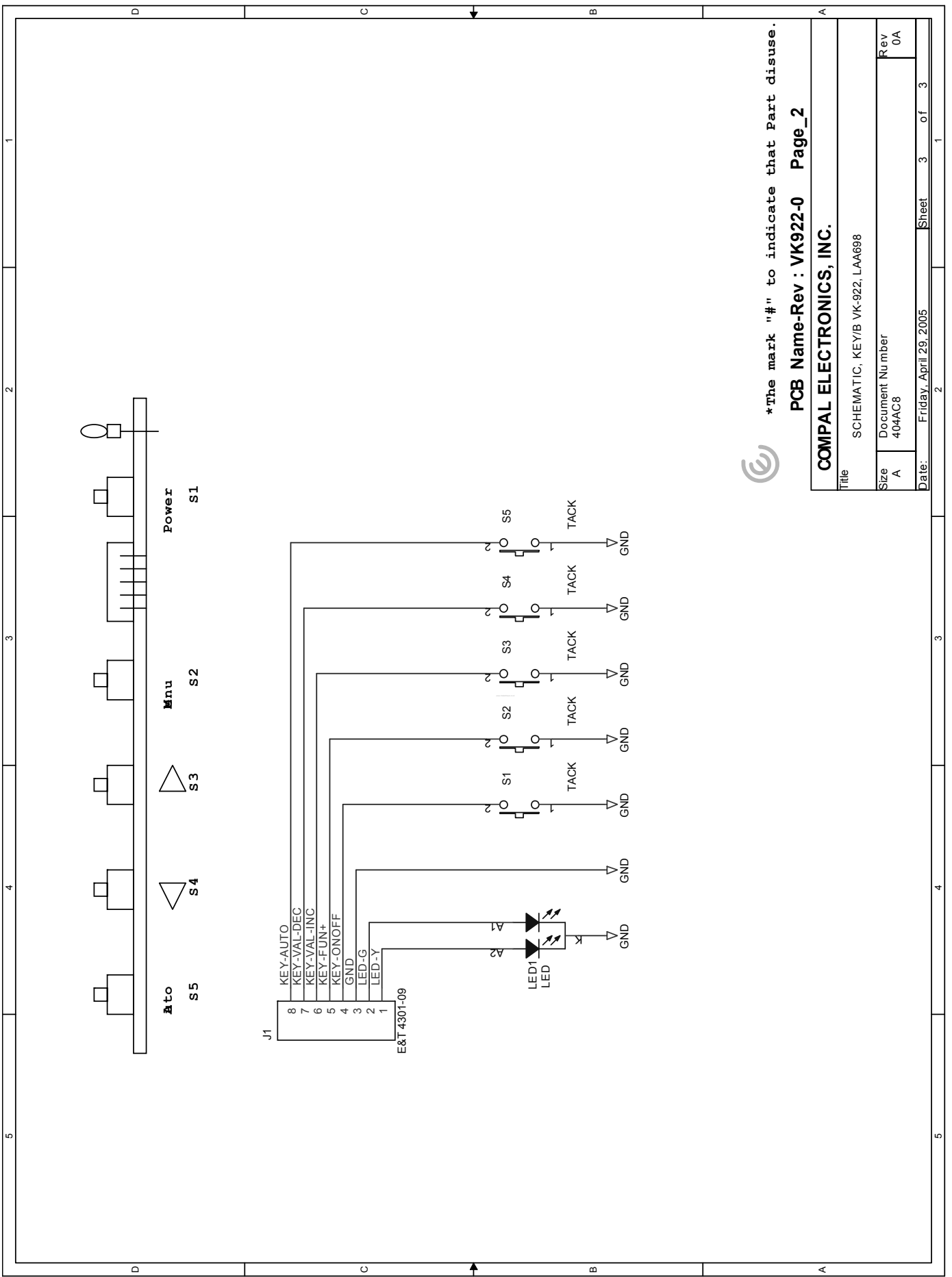

\*The mark "#" to indicate that Part disuse.  
**PCB Name-Rev : VK922-0 Page\_2**

<b>COMPAL ELECTRONICS, INC.</b>	
Title SCHEMATIC, KEY/B VK-922, LAA698	
Size A	Document Number 404AC8
Date: Friday, April 29, 2005	Rev 0A
Sheet 3	of 3