

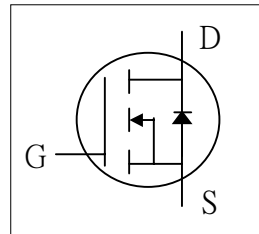

- ▼ Dynamic dv/dt Rating
- ▼ Repetitive Avalanche Rated
- ▼ Fast Switching
- ▼ Simple Drive Requirement



BV_{DSS}	600/675V
$R_{DS(ON)}$	1.2 Ω
I_D	7A

Description

AP07N70 series are specially designed as main switching devices for universal 90~265VAC off-line AC/DC converter applications. TO-220FM & TO-220CFM type provide high blocking voltage to overcome voltage surge and sag in the toughest power system with the best combination of fast switching, ruggedized design and cost-effectiveness.

The TO-220FM & TO-220CFM package is universally preferred for all commercial-industrial applications. The device is suited for switch mode power supplies, DC-AC converters and high current high speed switching circuits.

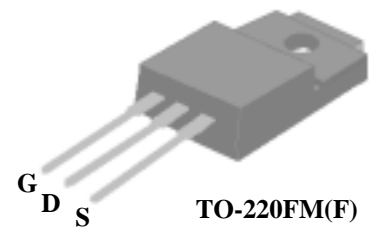

TO-220FM(F)

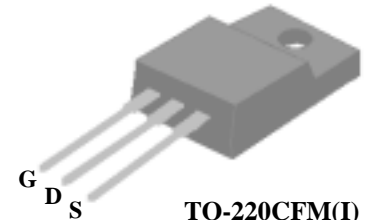

TO-220CFM(I)

Absolute Maximum Ratings

Symbol	Parameter	Rating	Units
V_{DS}	Drain-Source Voltage - /A	600/675	V
V_{GS}	Gate-Source Voltage	± 30	V
$I_D @ T_C=25^\circ C$	Continuous Drain Current, $V_{GS} @ 10V$	7	A
$I_D @ T_C=100^\circ C$	Continuous Drain Current, $V_{GS} @ 10V$	4.4	A
I_{DM}	Pulsed Drain Current ¹	18	A
$P_D @ T_C=25^\circ C$	Total Power Dissipation	37	W
	Linear Derating Factor	0.3	W/ $^\circ C$
E_{AS}	Single Pulse Avalanche Energy ²	140	mJ
I_{AR}	Avalanche Current	7	A
E_{AR}	Repetitive Avalanche Energy	7	mJ
T_{STG}	Storage Temperature Range	-55 to 150	$^\circ C$
T_J	Operating Junction Temperature Range	-55 to 150	$^\circ C$

Thermal Data

Symbol	Parameter	Value	Unit
Rthj-c	Thermal Resistance Junction-case Max.	3.4	$^\circ C/W$
Rthj-a	Thermal Resistance Junction-ambient Max.	65	$^\circ C/W$



AP07N70CF/I

Electrical Characteristics @ $T_j=25^\circ\text{C}$ (unless otherwise specified)

Symbol	Parameter	Test Conditions	Min.	Typ.	Max.	Units
BV_{DSS}	Drain-Source Breakdown Voltage	$V_{GS}=0V, I_D=1mA$ / -	600	-	-	V
		$V_{GS}=0V, I_D=1mA$ / A	675	-	-	V
$\Delta BV_{DSS}/\Delta T_j$	Breakdown Voltage Temperature Coefficient	Reference to 25°C , $I_D=1mA$	-	0.6	-	$V/^\circ\text{C}$
$R_{DS(ON)}$	Static Drain-Source On-Resistance	$V_{GS}=10V, I_D=3.5A$	-	-	1.2	Ω
$V_{GS(th)}$	Gate Threshold Voltage	$V_{DS}=V_{GS}, I_D=250\mu A$	2	-	4	V
g_{fs}	Forward Transconductance	$V_{DS}=50V, I_D=3.5A$	-	4.5	-	S
I_{DSS}	Drain-Source Leakage Current ($T_j=25^\circ\text{C}$)	$V_{DS}=670V, V_{GS}=0V$	-	-	10	μA
	Drain-Source Leakage Current ($T_j=150^\circ\text{C}$)	$V_{DS}=480V, V_{GS}=0V$	-	-	100	μA
I_{GSS}	Gate-Source Leakage	$V_{GS}=\pm 30V$	-	-	± 100	nA
Q_g	Total Gate Charge ³	$I_D=7A$ $V_{DS}=480V$ $V_{GS}=10V$	-	32	-	nC
Q_{gs}	Gate-Source Charge		-	8.6	-	nC
Q_{gd}	Gate-Drain ("Miller") Charge		-	9	-	nC
$t_{d(on)}$	Turn-on Delay Time ³	$V_{DD}=300V$ $I_D=7A$	-	17	-	ns
t_r	Rise Time		-	15	-	ns
$t_{d(off)}$	Turn-off Delay Time	$R_G=10\Omega, V_{GS}=10V$	-	35	-	ns
t_f	Fall Time	$R_D=43\Omega$	-	18	-	ns
C_{iss}	Input Capacitance	$V_{GS}=0V$	-	2075	-	pF
C_{oss}	Output Capacitance	$V_{DS}=25V$	-	120	-	pF
C_{riss}	Reverse Transfer Capacitance	$f=1.0MHz$	-	8	-	pF

Source-Drain Diode

Symbol	Parameter	Test Conditions	Min.	Typ.	Max.	Units
I_S	Continuous Source Current (Body Diode)	$V_D=V_G=0V, V_S=1.5V$	-	-	7	A
I_{SM}	Pulsed Source Current (Body Diode) ¹		-	-	18	A
V_{SD}	Forward On Voltage ³	$T_j=25^\circ\text{C}, I_S=7A, V_{GS}=0V$	-	-	1.5	V

Notes:

- Pulse width limited by safe operating area.
- Starting $T_j=25^\circ\text{C}$, $V_{DD}=50V$, $L=5mH$, $R_G=25\Omega$, $I_{AS}=7A$.
- Pulse width $\leq 300\mu s$, duty cycle $\leq 2\%$.

Ordering Code

AP07N70CF(/I)-X : X Denote BV_{DSS} Grade

Blank = BV_{DSS} 600V

A = BV_{DSS} 675V

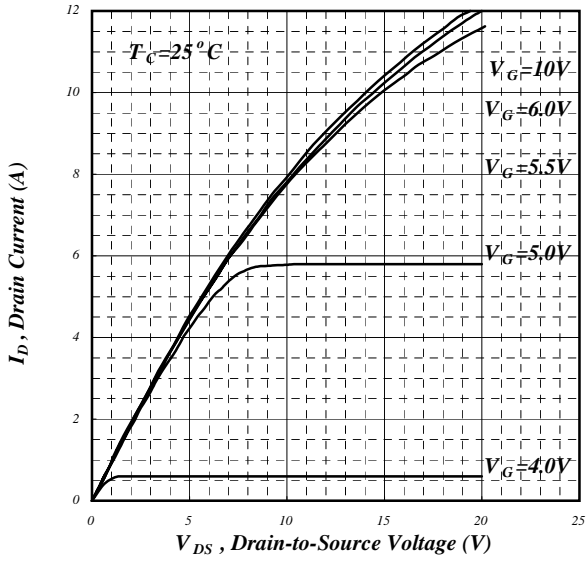

Fig 1. Typical Output Characteristics

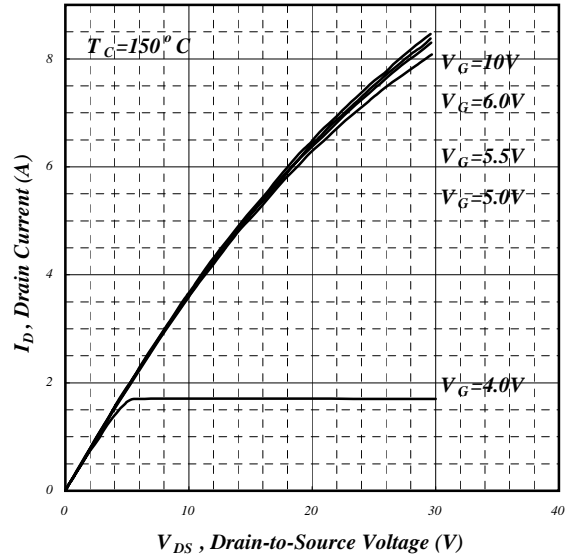

Fig 2. Typical Output Characteristics

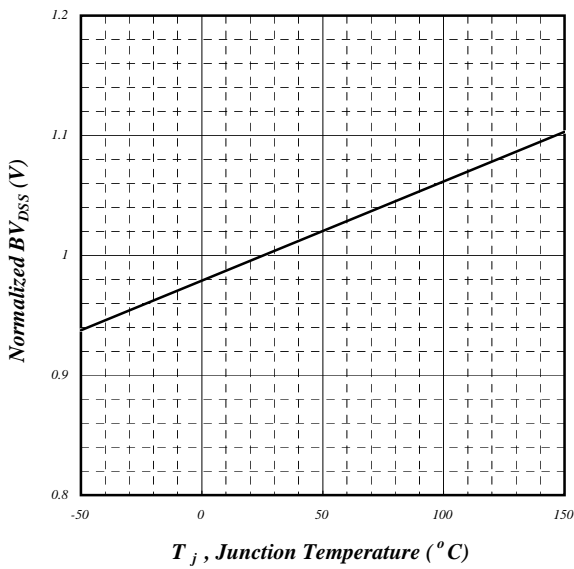

Fig 3. Normalized BV_{DSS} v.s. Junction Temperature

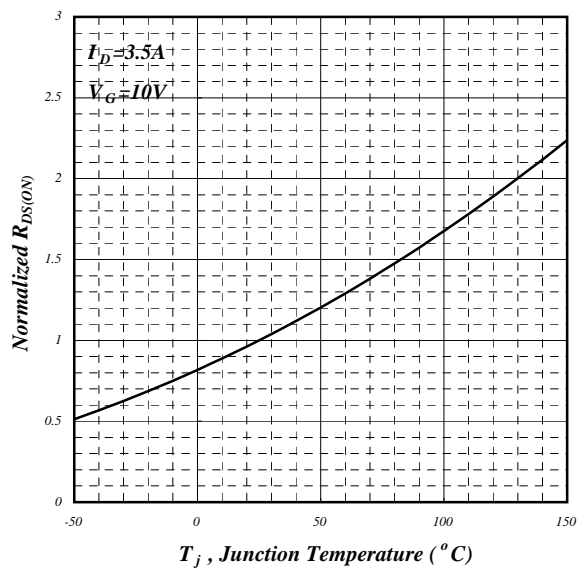

Fig 4. Normalized On-Resistance v.s. Junction Temperature

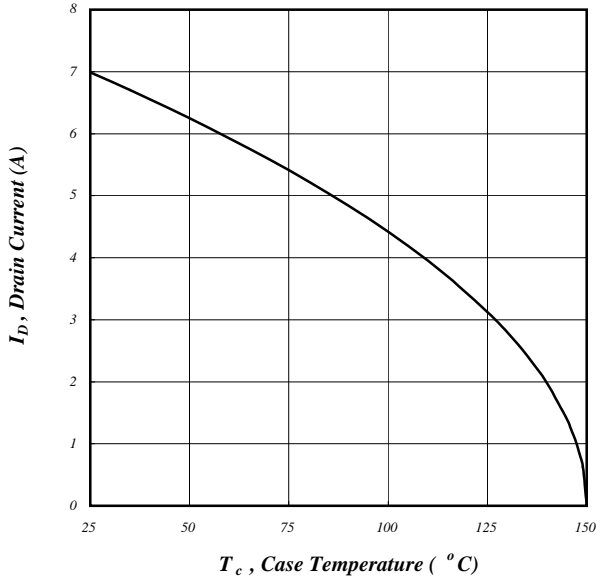

Fig 5. Maximum Drain Current v.s. Case Temperature

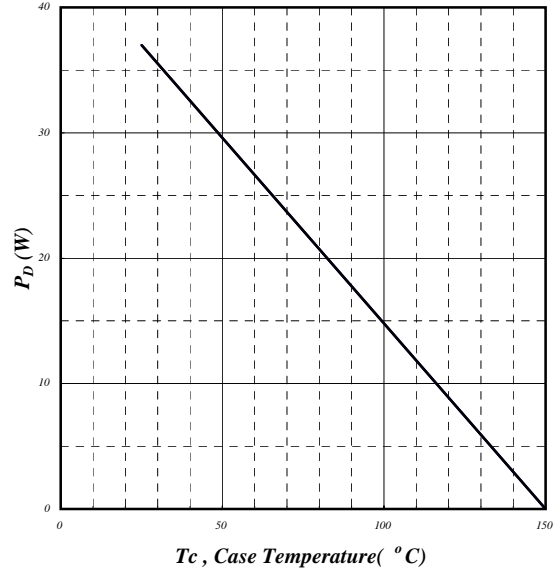

Fig 6. Typical Power Dissipation

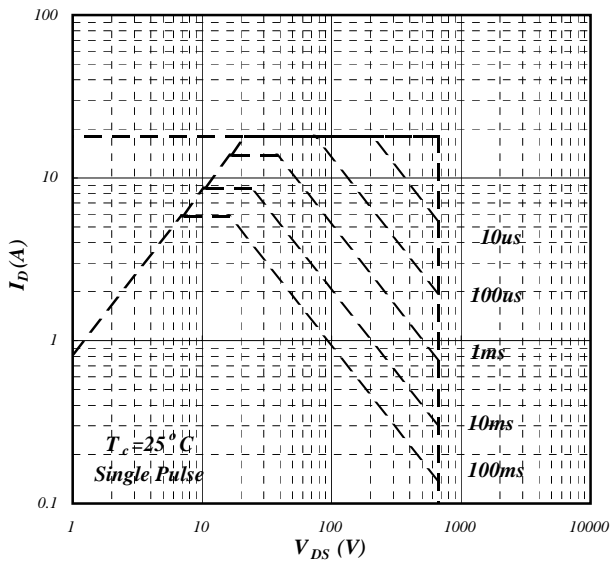

Fig 7. Maximum Safe Operating Area

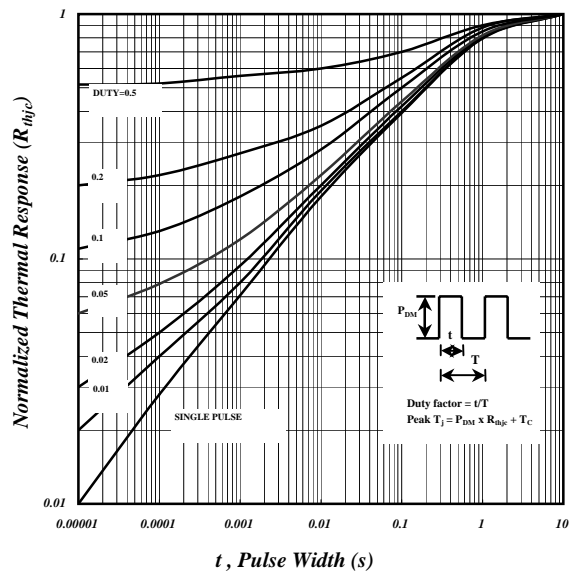

Fig 8. Effective Transient Thermal Impedance

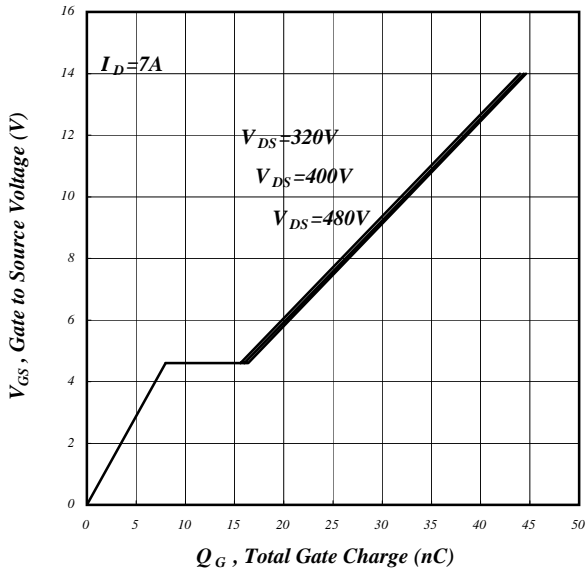

Fig 9. Gate Charge Characteristics

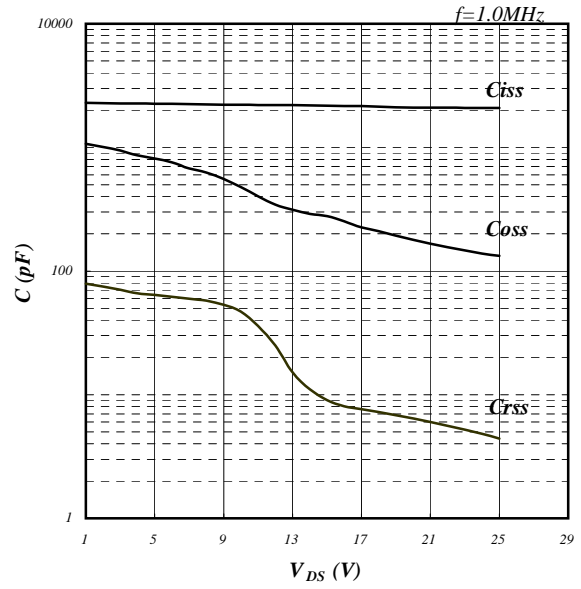

Fig 10. Typical Capacitance Characteristics

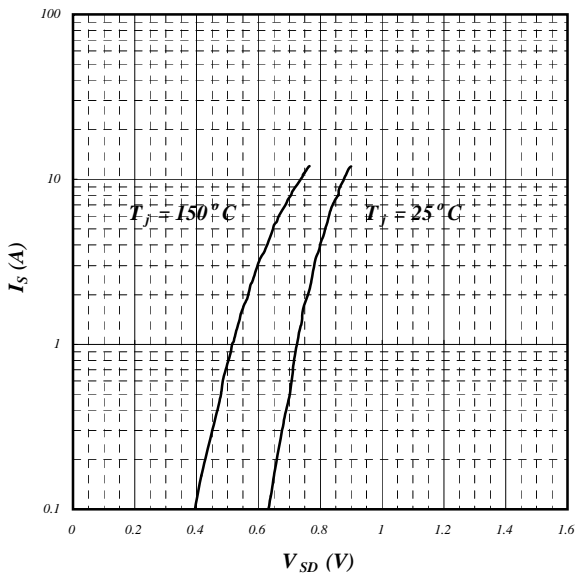

Fig 11. Forward Characteristic of Reverse Diode

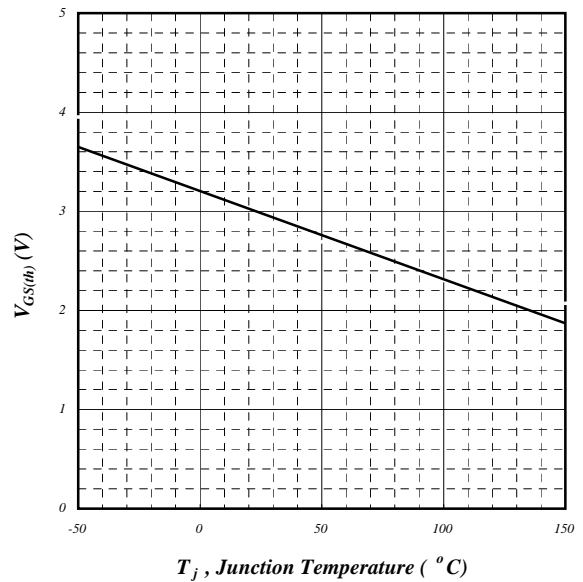

Fig 12. Gate Threshold Voltage v.s. Junction Temperature

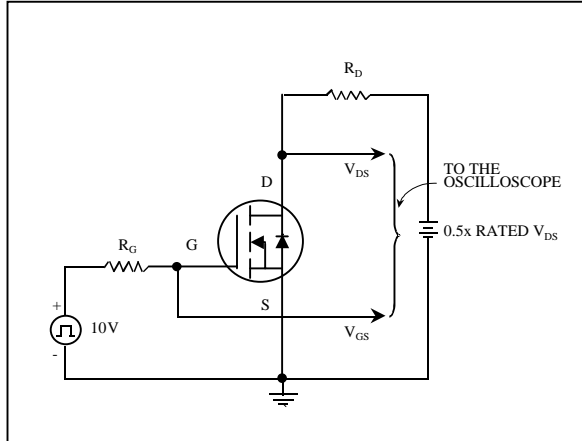

Fig 13. Switching Time Circuit

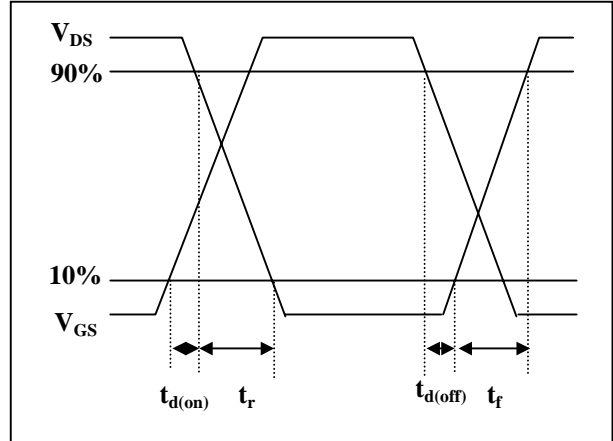

Fig 14. Switching Time Waveform

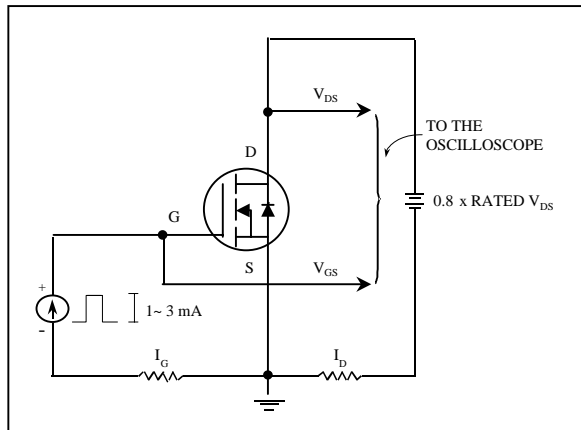

Fig 15. Gate Charge Circuit

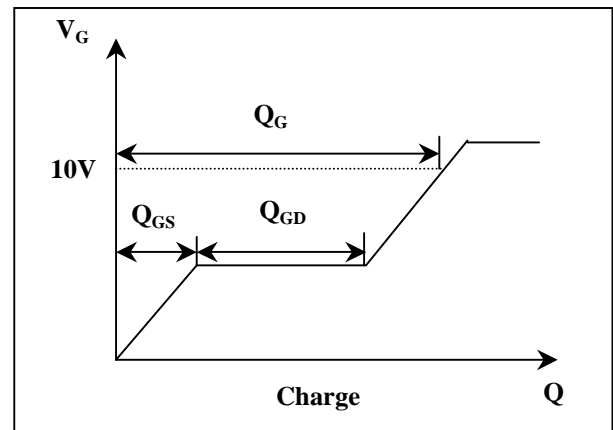

Fig 16. Gate Charge Waveform