

AUTOMOTIVE MOSFET

IRFBA1405P

Typical Applications

- Electric Power Steering (EPS)
- Anti-lock Braking System (ABS)
- Wiper Control
- Climate Control
- Power Door

Benefits

- Advanced Process Technology
- Ultra Low On-Resistance
- Dynamic dv/dt Rating
- 175°C Operating Temperature
- Fast Switching
- Repetitive Avalanche Allowed up to Tjmax

Description

Specifically designed for Automotive applications, this Stripe Planar design of HEXFET® Power MOSFETs utilizes the latest processing techniques to achieve extremely low on-resistance per silicon area. Additional features of this MOSFET are a 175°C junction operating temperature, fast switching speed and improved ruggedness in single and repetitive avalanche. The Super-220™ is a package that has been designed to have the same mechanical outline and pinout as the industry standard TO-220 but can house a considerably larger silicon die. The result is significantly increased current handling capability over both the TO-220 and the much larger TO-247 package. The combination of extremely low on-resistance silicon and the Super-220™ package makes it ideal to reduce the component count in multiparalleled TO-220 applications, reduce system power dissipation, upgrade existing designs or have TO-247 performance in a TO-220 outline. This package has been designed to meet automotive, Q101, qualification standard.

These benefits make this design an extremely efficient and reliable device for use in Automotive applications and a wide variety of other applications.

Absolute Maximum Ratings

	Parameter	Max.	Units
I _D @ T _C = 25°C	Continuous Drain Current, V _{GS} @ 10V	174 [Ⓒ]	A
I _D @ T _C = 100°C	Continuous Drain Current, V _{GS} @ 10V	123 [Ⓒ]	
I _{DM}	Pulsed Drain Current [Ⓓ]	680	
P _D @ T _C = 25°C	Power Dissipation	330	W
	Linear Derating Factor	2.2	W/°C
V _{GS}	Gate-to-Source Voltage	± 20	V
E _{AS}	Single Pulse Avalanche Energy [Ⓔ]	560	mJ
I _{AR}	Avalanche Current	See Fig.12a, 12b, 15, 16	A
E _{AR}	Repetitive Avalanche Energy [Ⓕ]		mJ
dv/dt	Peak Diode Recovery dv/dt [Ⓖ]	5.0	V/ns
T _J	Operating Junction and	-40 to + 175	°C
T _{STG}	Storage Temperature Range	-55 to + 175	
	Soldering Temperature, for 10 seconds	300 (1.6mm from case)	
	Recommended clip force	20	N

HEXFET® Power MOSFET

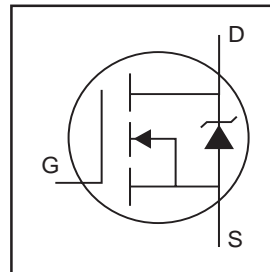

V _{DSS} = 55V
R _{DS(on)} = 5.0mΩ
I _D = 174A [Ⓒ]

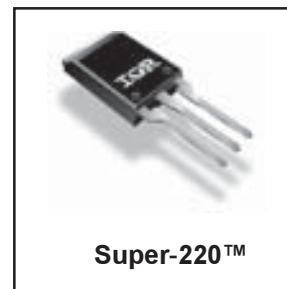

Electrical Characteristics @ T_J = 25°C (unless otherwise specified)

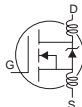
	Parameter	Min.	Typ.	Max.	Units	Conditions
V _{(BR)DSS}	Drain-to-Source Breakdown Voltage	55	—	—	V	V _{GS} = 0V, I _D = 250μA
ΔV _{(BR)DSS/ΔT_J}	Breakdown Voltage Temp. Coefficient	—	0.057	—	V/°C	Reference to 25°C, I _D = 1mA
R _{DS(on)}	Static Drain-to-Source On-Resistance	—	4.3	5.0	mΩ	V _{GS} = 10V, I _D = 101A ④
V _{GS(th)}	Gate Threshold Voltage	2.0	—	4.0	V	V _{DS} = 10V, I _D = 250μA
g _{fs}	Forward Transconductance	69	—	—	S	V _{DS} = 25V, I _D = 110A
I _{DSS}	Drain-to-Source Leakage Current	—	—	20	μA	V _{DS} = 55V, V _{GS} = 0V
		—	—	250		V _{DS} = 44V, V _{GS} = 0V, T _J = 150°C
I _{GSS}	Gate-to-Source Forward Leakage	—	—	200	nA	V _{GS} = 20V
	Gate-to-Source Reverse Leakage	—	—	-200		V _{GS} = -20V
Q _g	Total Gate Charge	—	170	260	nC	I _D = 101A
Q _{gs}	Gate-to-Source Charge	—	44	66		V _{DS} = 44V
Q _{gd}	Gate-to-Drain ("Miller") Charge	—	62	93		V _{GS} = 10V ④
t _{d(on)}	Turn-On Delay Time	—	13	—	ns	V _{DD} = 38V
t _r	Rise Time	—	190	—		I _D = 110A
t _{d(off)}	Turn-Off Delay Time	—	130	—		R _G = 1.1Ω
t _f	Fall Time	—	110	—		V _{GS} = 10V ④
L _D	Internal Drain Inductance	—	4.5	—	nH	Between lead, 6mm (0.25in.) from package and center of die contact
L _S	Internal Source Inductance	—	7.5	—		
C _{iss}	Input Capacitance	—	5480	—	pF	V _{GS} = 0V
C _{oss}	Output Capacitance	—	1210	—		V _{DS} = 25V
C _{rss}	Reverse Transfer Capacitance	—	280	—		f = 1.0MHz, See Fig. 5
C _{oss}	Output Capacitance	—	5210	—		V _{GS} = 0V, V _{DS} = 1.0V, f = 1.0MHz
C _{oss}	Output Capacitance	—	900	—		V _{GS} = 0V, V _{DS} = 44V, f = 1.0MHz
C _{oss eff.}	Effective Output Capacitance ③	—	1500	—		V _{GS} = 0V, V _{DS} = 0V to 44V

Source-Drain Ratings and Characteristics

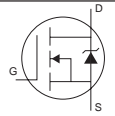
	Parameter	Min.	Typ.	Max.	Units	Conditions
I _S	Continuous Source Current (Body Diode)	—	—	174⑥	A	MOSFET symbol showing the integral reverse p-n junction diode. 
I _{SM}	Pulsed Source Current (Body Diode) ①	—	—	680		
V _{SD}	Diode Forward Voltage	—	—	1.3	V	T _J = 25°C, I _S = 101A, V _{GS} = 0V ④
t _{rr}	Reverse Recovery Time	—	88	130	ns	T _J = 25°C, I _F = 101A
Q _{rr}	Reverse Recovery Charge	—	250	380	nC	di/dt = 100A/μs ④
t _{on}	Forward Turn-On Time	Intrinsic turn-on time is negligible (turn-on is dominated by L _S +L _D)				

Thermal Resistance

	Parameter	Typ.	Max.	Units
R _{θJC}	Junction-to-Case	—	0.45	°C/W
R _{θCS}	Case-to-Sink, Flat, Greased Surface	0.50	—	
R _{θJA}	Junction-to-Ambient	—	58	

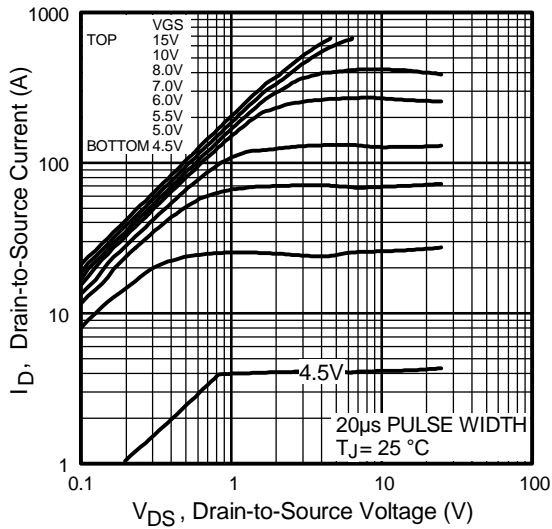

Fig 1. Typical Output Characteristics

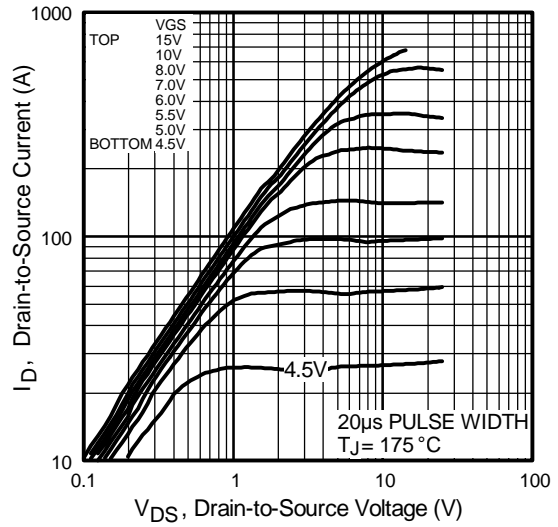

Fig 2. Typical Output Characteristics

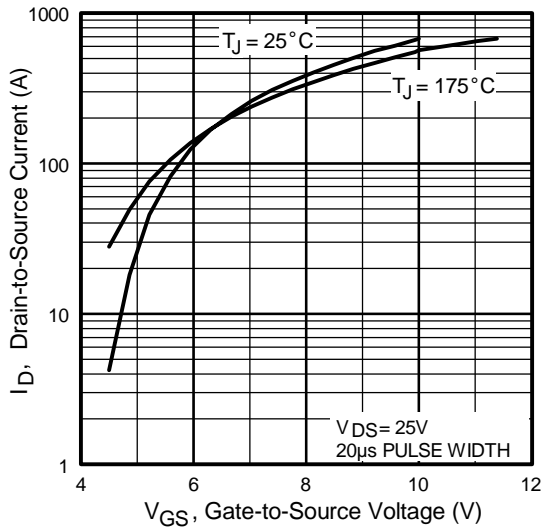

Fig 3. Typical Transfer Characteristics

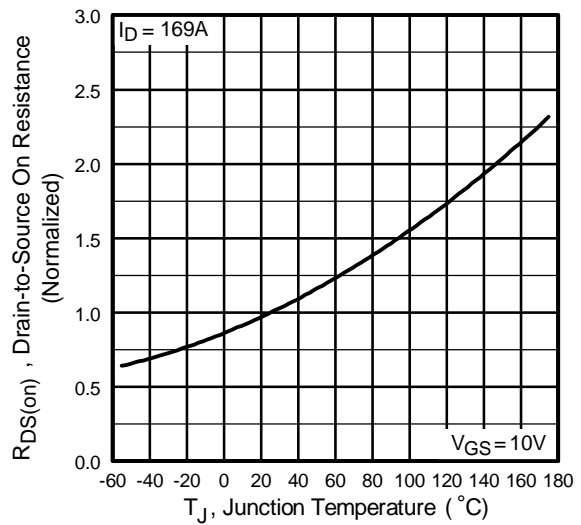

Fig 4. Normalized On-Resistance Vs. Temperature

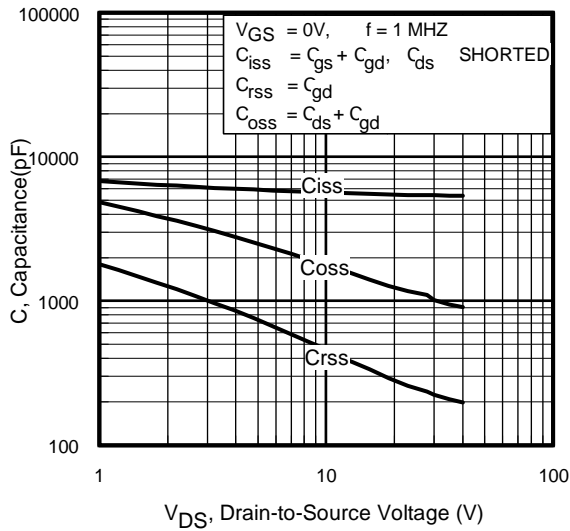

Fig 5. Typical Capacitance Vs. Drain-to-Source Voltage

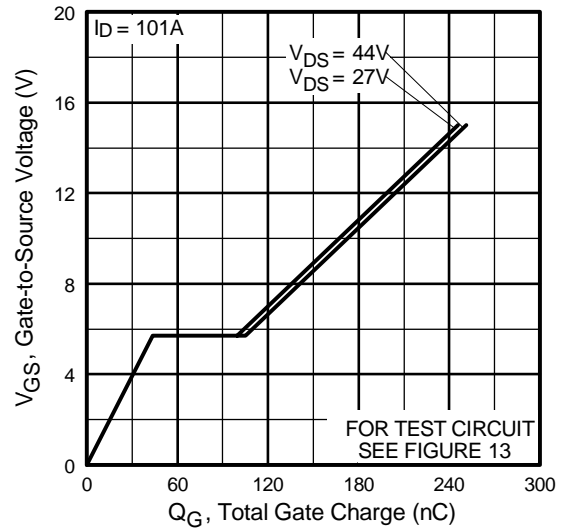

Fig 6. Typical Gate Charge Vs. Gate-to-Source Voltage

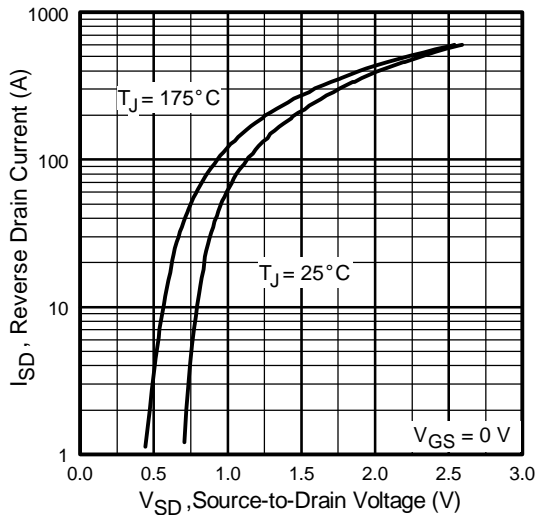

Fig 7. Typical Source-Drain Diode Forward Voltage

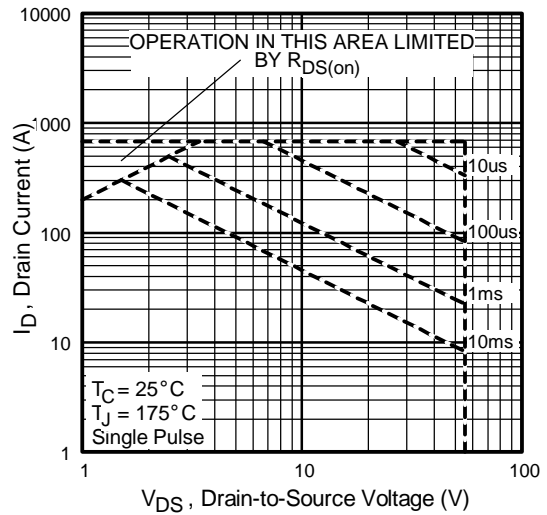

Fig 8. Maximum Safe Operating Area

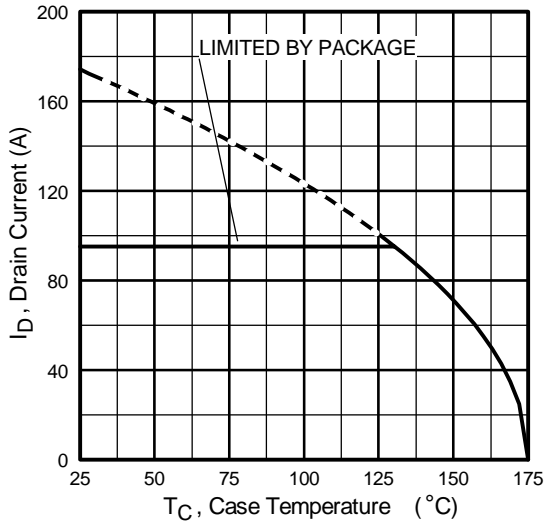

Fig 9. Maximum Drain Current Vs. Case Temperature

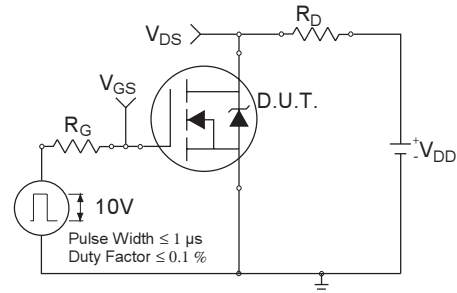

Fig 10a. Switching Time Test Circuit

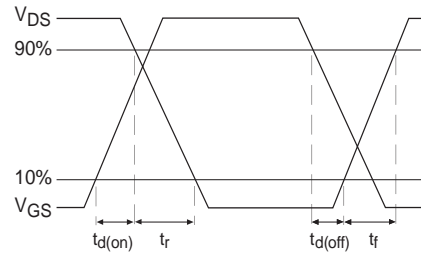

Fig 10b. Switching Time Waveforms

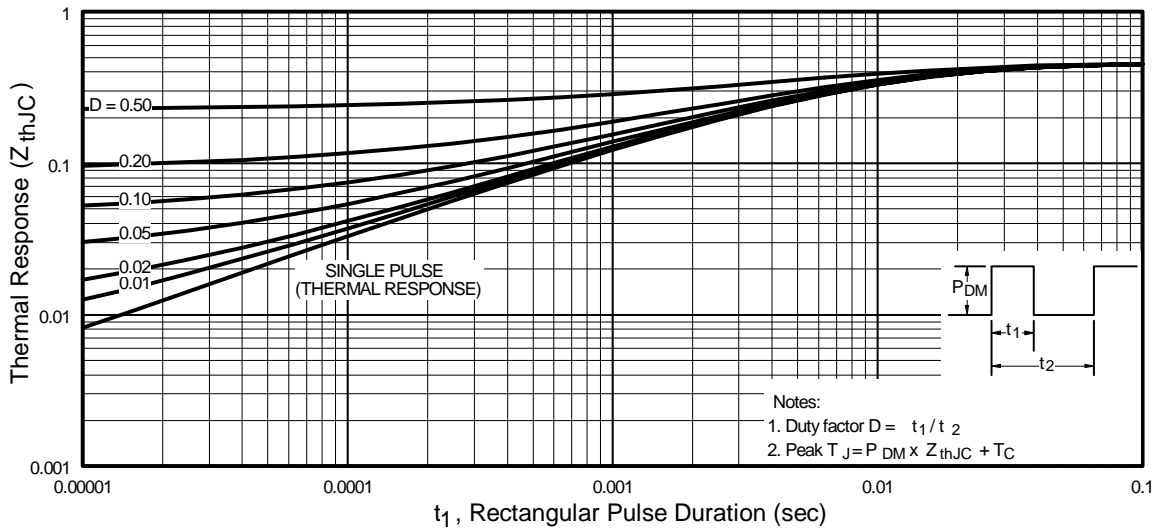

Fig 11. Maximum Effective Transient Thermal Impedance, Junction-to-Case

IRFBA1405P

International
IR Rectifier

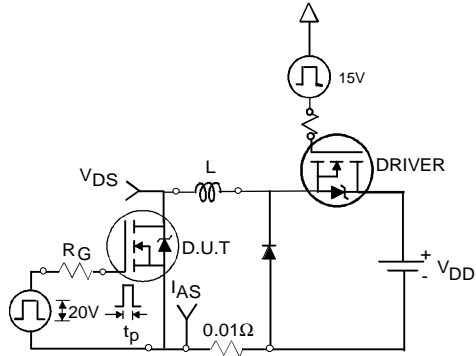

Fig 12a. Unclamped Inductive Test Circuit



Fig 12b. Unclamped Inductive Waveforms



Fig 13a. Basic Gate Charge Waveform

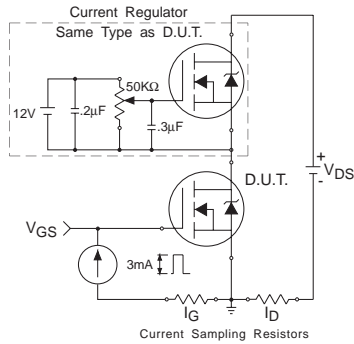

Fig 13b. Gate Charge Test Circuit

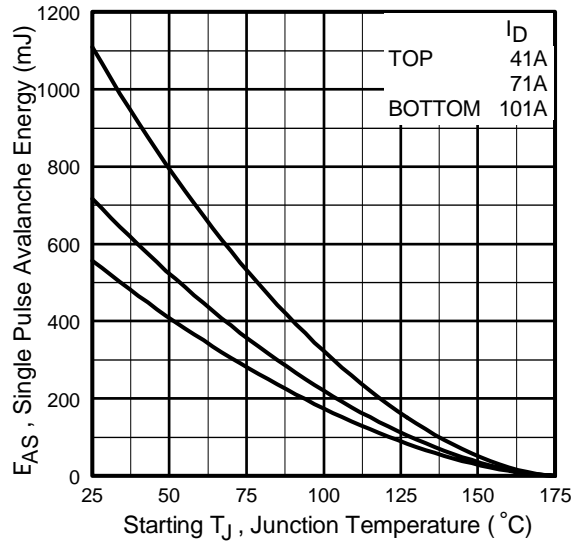

Fig 12c. Maximum Avalanche Energy Vs. Drain Current

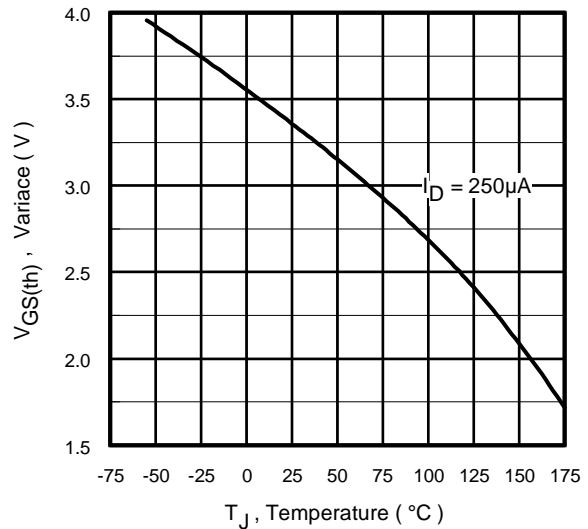

Fig 14. Threshold Voltage Vs. Temperature

www.irf.com

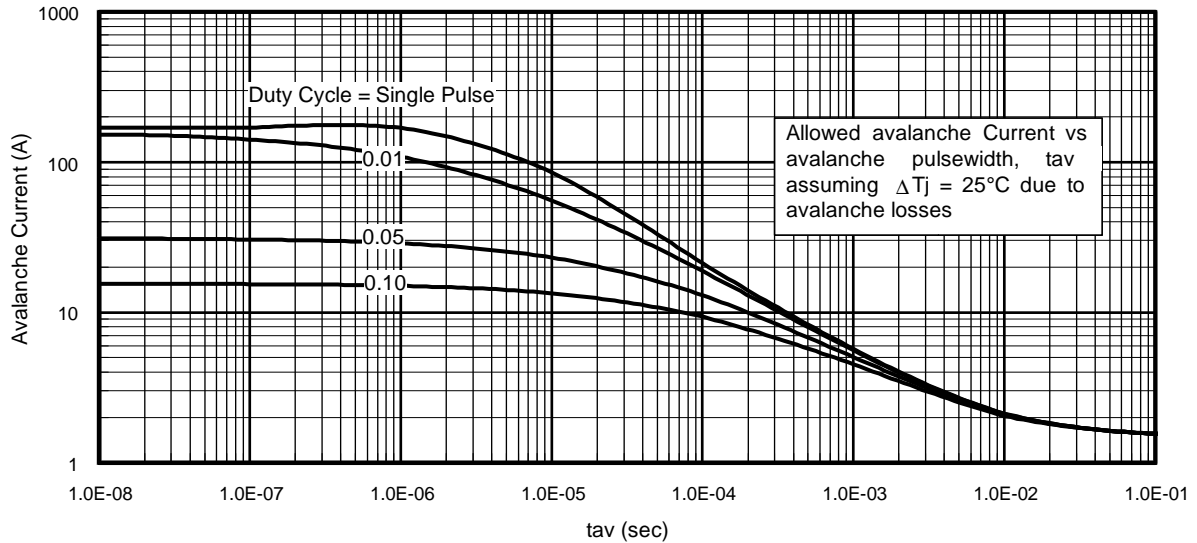

Fig 15. Typical Avalanche Current Vs.Pulsewidth

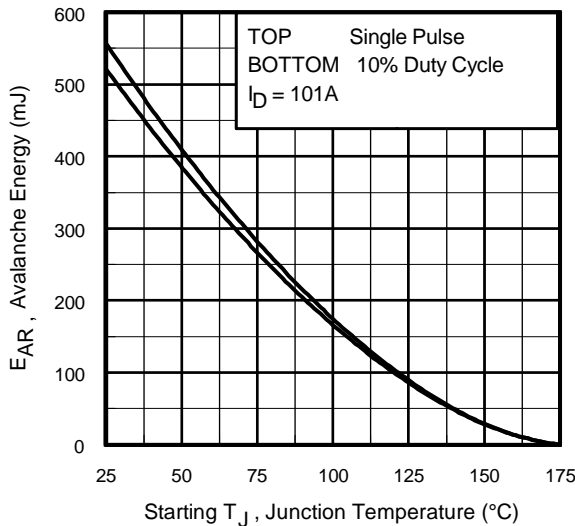

Fig 16. Maximum Avalanche Energy Vs. Temperature

Notes on Repetitive Avalanche Curves , Figures 15, 16:
(For further info, see AN-1005 at www.irf.com)

1. Avalanche failures assumption:
Purely a thermal phenomenon and failure occurs at a temperature far in excess of T_{jmax} . This is validated for every part type.
2. Safe operation in Avalanche is allowed as long as T_{jmax} is not exceeded.
3. Equation below based on circuit and waveforms shown in Figures 12a, 12b.
4. $P_{D(ave)}$ = Average power dissipation per single avalanche pulse.
5. BV = Rated breakdown voltage (1.3 factor accounts for voltage increase during avalanche).
6. I_{av} = Allowable avalanche current.
7. ΔT = Allowable rise in junction temperature, not to exceed T_{jmax} (assumed as 25°C in Figure 15, 16).
 t_{av} = Average time in avalanche.
 D = Duty cycle in avalanche = $t_{av} \cdot f$
 $Z_{thJC}(D, t_{av})$ = Transient thermal resistance, see figure 11)

$$P_{D(ave)} = 1/2 (1.3 \cdot BV \cdot I_{av}) = \Delta T / Z_{thJC}$$

$$I_{av} = 2\Delta T / [1.3 \cdot BV \cdot Z_{th}]$$

$$E_{AS(AR)} = P_{D(ave)} \cdot t_{av}$$

Peak Diode Recovery dv/dt Test Circuit

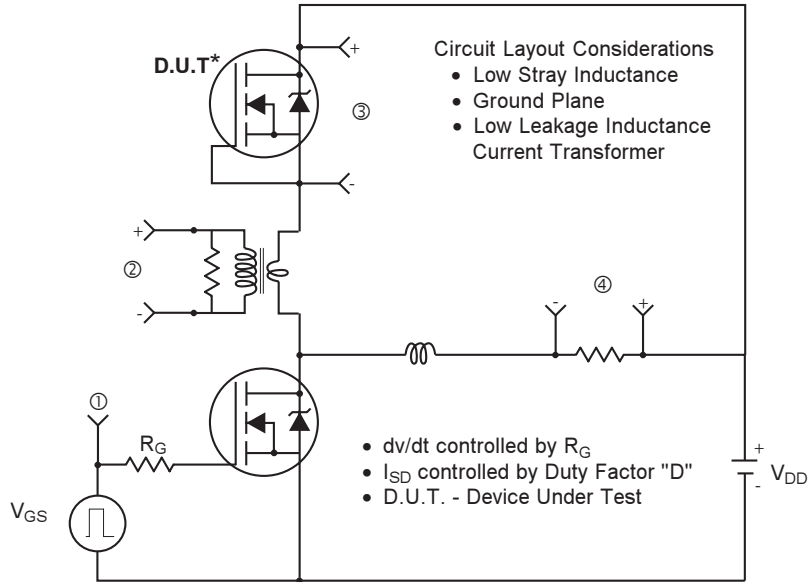

* Reverse Polarity of D.U.T for P-Channel

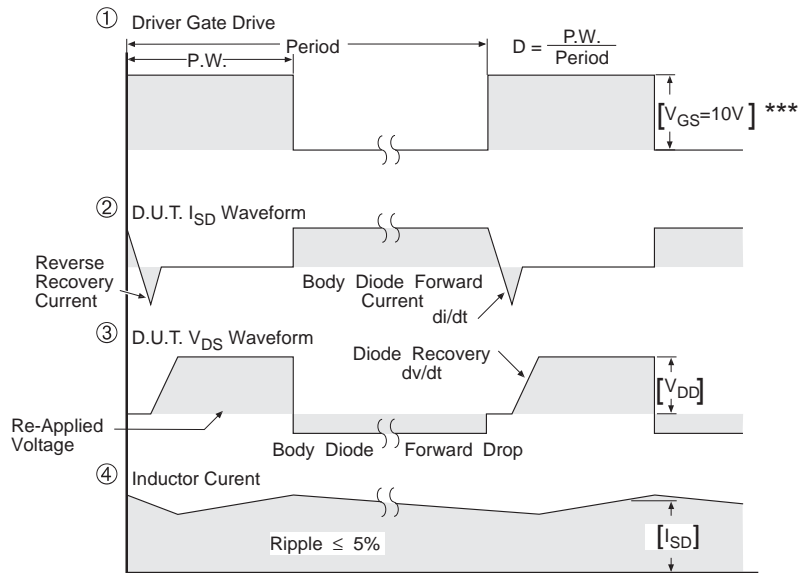

*** $V_{GS} = 5.0V$ for Logic Level and 3V Drive Devices

Fig 17. For N-channel HEXFET® power MOSFETs

Super-220™ Package Outline

IRFBA1405P

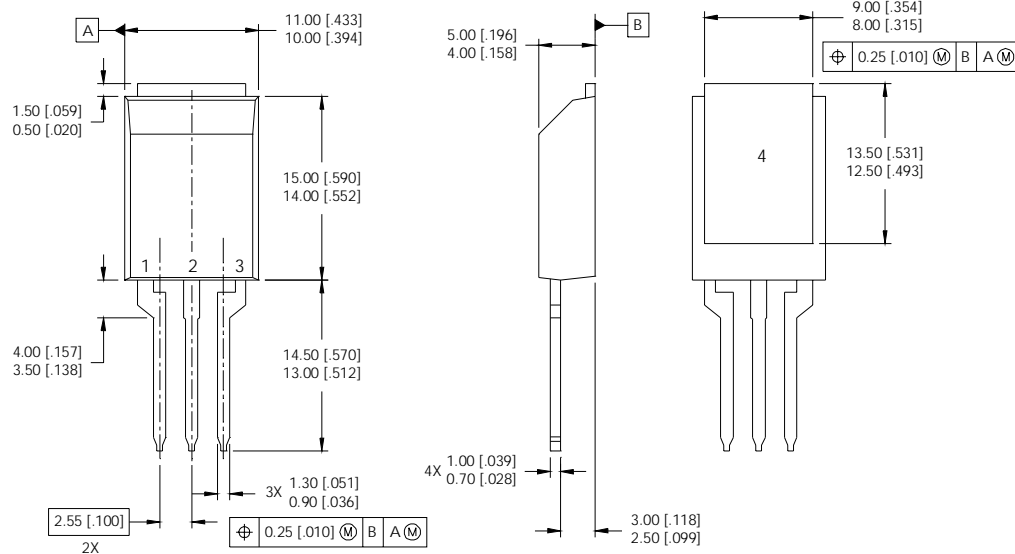

NOTES:

1. DIMENSIONING & TOLERANCING PER ASME Y14.5M-1994.
2. CONTROLLING DIMENSION: MILLIMETER.
3. DIMENSIONS ARE SHOWN IN MILLIMETERS [INCHES].
4. OUTLINE CONFORMS TO JEDEC OUTLINE TO-273AA.

LEAD ASSIGNMENTS

MOSFET	IGBT
1 - GATE	1 - GATE
2 - DRAIN	2 - COLLECTOR
3 - SOURCE	3 - EMITTER
4 - DRAIN	4 - COLLECTOR

Notes:

- ① Repetitive rating; pulse width limited by max. junction temperature. (See fig. 11).
- ② Starting $T_J = 25^\circ\text{C}$, $L = 0.11\text{mH}$
 $R_G = 25\Omega$, $I_{AS} = 101\text{A}$. (See Figure 12).
- ③ $I_{SD} \leq 101\text{A}$, $di/dt \leq 210\text{A}/\mu\text{s}$, $V_{DD} \leq V_{(BR)DSS}$,
 $T_J \leq 175^\circ\text{C}$
- ④ Pulse width $\leq 400\mu\text{s}$; duty cycle $\leq 2\%$.
- ⑤ C_{oss} eff. is a fixed capacitance that gives the same charging time as C_{oss} while V_{DS} is rising from 0 to 80% V_{DSS} . Refer to AN-1001
- ⑥ Calculated continuous current based on maximum allowable junction temperature. Package limitation current is 95A.
- ⑦ Limited by T_{Jmax} , see Fig.12a, 12b, 15, 16 for typical repetitive avalanche performance.

Data and specifications subject to change without notice.

This product has been designed and qualified for the automotive [Q101] market.

Qualification Standards can be found on IR's Web site.

Super-220™ not recommended for surface mount application

International
IR Rectifier

IR WORLD HEADQUARTERS: 233 Kansas St., El Segundo, California 90245, USA Tel: (310) 252-7105
TAC Fax: (310) 252-7903

Visit us at www.irf.com for sales contact information. 8/02