

## Low IR Schottky barrier diode

### Features

- Low IR
- Low VF
- Center tap connection

### Applications

- High frequency operation
- DC-DC converters
- AC adapter

### Outline drawings, mm

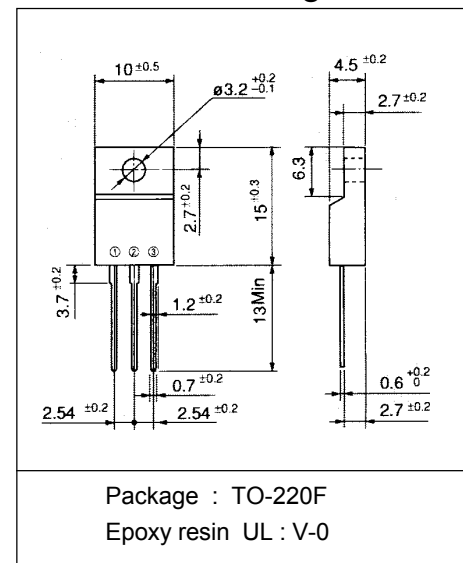

### Connection diagram

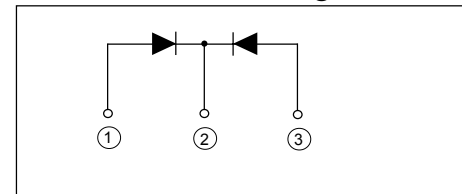

### Maximum ratings and characteristics

#### Maximum ratings

Item	Symbol	Conditions	Rating	Unit
Repetitive peak surge reverse voltage	$V_{RSM}$	tw=500ns, duty=1/40	60	V
Repetitive peak reverse voltage	$V_{RRM}$		60	V
Isolating voltage	Viso	Terminals-to-Case, AC. 1min.	1500	V
Average output current	$I_o$	Square wave, duty=1/2 $T_c=101^\circ\text{C}$	30 *	A
Non-repetitive surge current	$I_{FSM}$	Sine wave 10ms	160	A
non-repetitive reverse surge power dissipation	PRM	tw=10 $\mu$ s, $T_j=25^\circ\text{C}$	750	W
Operating junction temperature	$T_j$		+150	$^\circ\text{C}$
Storage temperature	$T_{stg}$		-40 to +150	$^\circ\text{C}$

\* Out put current of center tap full wave connection

#### Electrical characteristics (at $T_a=25^\circ\text{C}$ Unless otherwise specified )

Item	Symbol	Conditions	Max.	Unit
Forward voltage **	$V_F$	$I_F=15\text{A}$	0.74	V
Reverse current **	$I_R$	$V_R=60\text{V}$	200	$\mu\text{A}$
Thermal resistance	$R_{th(j-c)}$	Junction to case	2.0	$^\circ\text{C/W}$

\*\*Rating per element

#### Mechanical characteristics

Mounting torque	Recommended torque	0.3 to 0.5	N·m
Approximate mass		2	g

■ Characteristics

