

SIKOREL®

Applications

- For high-voltage applications in automotive

Features

- High ripple current capability
- Long useful life
- High vibration resistance
- Shelf life up to 15 years

Construction

- Charge-discharge proof, polar
- Aluminum case with insulating sleeve
- Negative pole connected to case

Terminals

- Axial leads, welded to ensure perfect electrical contact
- Also available with soldering stars

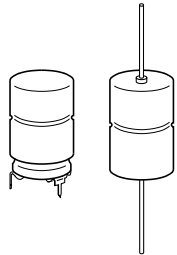

KAL0573-K

Taping and packing

- Axial-lead capacitors will be delivered in pallet package.
Capacitors with $d \times l \leq 16 \times 30$ mm are also available taped on reel.
- Solder-star capacitors are packed in cardboard.

For details on taping and packing, refer to page 342.

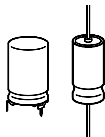
B43693 / B43793
High Voltage – 125 °C
Specifications and characteristics in brief

Rated voltage U_R	160 and 250 VDC			
Surge voltage U_S	$1,15 \cdot U_R$			
Rated capacitance C_R	22 ... 100 μF			
Capacitance tolerance	– 10/+ 30 % \triangleq Q			
Leakage current I_L (5 min, 20 °C)	$I_L \leq 0,006 \mu\text{A} \cdot \left(\frac{C_R}{\mu\text{F}} \cdot \frac{U_R}{\text{V}} \right) + 4 \mu\text{A}$			
Self-inductance $ESL^{1)}$	Diameter d	14 mm	16 mm	18 mm
	Length l / Terminal	Approx. ESL (nH)		
	25 mm axial / solder star	22 / 6	26 / 7	— / —
	30 mm axial / solder star	24 / 7	29 / 8	34 / 10
	39 mm axial / solder star	— / —	33 / 9	38 / 11
Useful life 125 °C; U_R ; 0,5 I_{R-} 105 °C; U_R ; I_{R-} 85 °C; U_R ; $I_{R-\text{max}}$ 40 °C; U_R ; 1,9 · I_{R-}	> 1 000 h > 4 000 h > 4 000 h > 200 000 h	Requirements: $\Delta C/C \leq \pm 30$ % of initial value $ESR \leq 3$ times initial limit $I_L \leq$ initial specified limit Failure percentage: $\leq 0,5$ % Failure rate: ≤ 10 fit ($\leq 10 \cdot 10^{-9}/\text{h}$) (for definiton "fit", refer to chapter "Quality", page 62)		
Voltage endurance test 105 °C; U_R	2 000 h	Post test requirements: $\Delta C/C \leq \pm 10$ % of initial value $ESR \leq 1,3$ % of specified limit $I_L \leq$ initial specified limit		
Vibration resistance	To IEC 60068-2-6, test Fc: displacement amplitude 1,5 mm, at 10 Hz to 2 kHz, acceleration max. 20 g, duration 3×2 h			
IEC climatic category	To IEC 60068-1: 40/125/56 (– 40 /+ 125 °C/56 days damp heat test)			
Detail specification	Similar to CECC 30301-802			
Sectional specification	IEC 60384-4			

1) If optimum circuit design is used, the values are lower by 30 %.

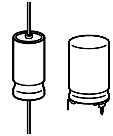

Dimensional drawings

Axial-lead capacitor

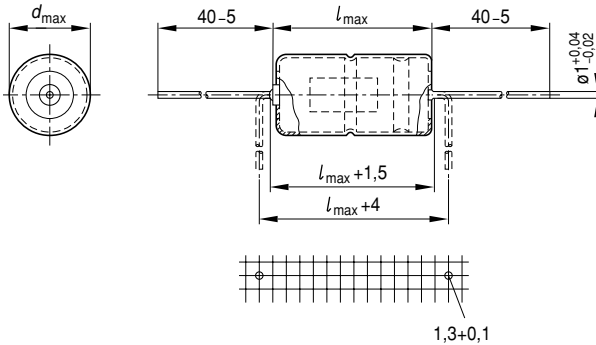

KAL0524-S

Dimensions, weights and packing units

$d \times l$ mm	$d_{\max} \times l_{\max}$ mm	Approx. weight g	Packing units (pieces)	
			Pallet	Reel
14 × 30	14,5 × 30,5	6,8	200	350
16 × 30	16,5 × 30,5	8,9	180	250
18 × 30	18,5 × 30,5	11,1	160	—
18 × 39	18,5 × 40	14,7	160	—

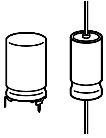

B43693 / B43793

High Voltage – 125 °C

Soldering star capacitors

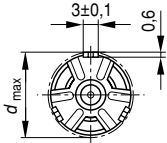

Mounting holes
 $d = 12 \text{ mm} \dots 14 \text{ mm}$

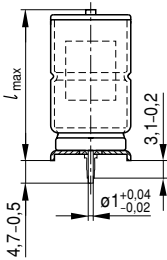
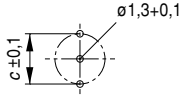

Mounting holes
 $d = 16 \text{ mm} \dots 18 \text{ mm}$

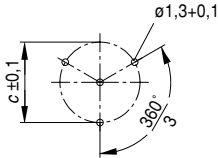

Soldering star is connected to the negative pole

KAL0525-1-E

The PC-board hole arrangement specified above is based on circular arcs.

If, however, the mounting holes have to be matched to a standard drilling raster, a spacing of 1,27 mm ($1/20''$) has proved to be sufficiently accurate if the following arrangements are used:

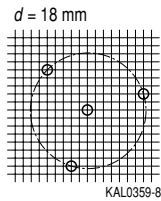
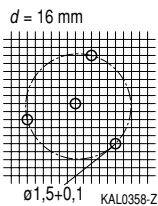
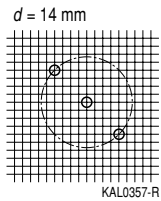

Dimensions, weights and packing units

$d \times l$ mm	$d_{\max} \times l_{\max}$ mm	$c \pm 0,1$ mm	Approx. weight g	Packing units pieces
14 × 30	15,5 × 32	14,5	7,2	480
16 × 30	17,5 × 32	16,5	9,4	300
18 × 30	19,5 × 32	18,5	11,8	300
18 × 39	19,5 × 41,5	18,5	15,4	200

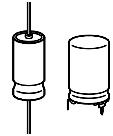
Overview of available types

U_R (VDC)	160	250
C_R (μ F)	Case dimensions $d \times l$ (mm)	
22		14 × 30
33	14 × 30	
47	16 × 30	18 × 30
68		18 × 39
100	18 × 39	

Case dimensions and ordering codes

U_R VDC	C_R μ F	Case dim. $d \times l$ mm	Ordering code Axial pallet package	Axial reel	Soldering star
160	33	14 × 30	B43693A1336Q007	B43693A1336Q009	B43793A1336Q000
	47	16 × 30	B43693A1476Q007	B43693A1476Q009	B43793A1476Q000
	100	18 × 39	B43693A1107Q007		B43793A1107Q000
250	22	14 × 30	B43693A2226Q007	B43693A2226Q009	B43793A2226Q000
	47	18 × 30	B43693A2476Q007		B43793A2476Q000
	68	18 × 39	B43693A2686Q007		B43793A2686Q000

Technical data

C_R 100 Hz 20 °C μ F	ESR_{typ} 100 Hz 20 °C m Ω	ESR_{max} 100 Hz 20 °C m Ω	ESR_{max} 100 Hz -40 °C Ω	ESR_{max} 10 kHz 20 °C m Ω	Z_{max} 100 kHz 20 °C m Ω	$I_{\sim max}$ 10 kHz 40 °C A	$I_{\sim max}$ 10 kHz 85 °C A	$I_{\sim R}$ 10 kHz 105 °C A	$I_{\sim max}$ 10 kHz 125 °C A
160 VDC									
33	1,10	1,70	20,0	530	530	3,30	2,75	1,10	0,55
47	0,75	1,20	14,0	370	360	4,15	3,45	1,40	0,70
100	0,36	0,60	7,0	175	170	6,85	5,80	2,30	1,15
250 VDC									
22	1,40	2,30	25,0	540	500	3,55	2,95	1,20	0,60
47	0,65	1,10	12,0	250	230	5,20	4,35	1,75	0,87
68	0,45	0,75	8,5	170	160	7,15	6,00	2,40	1,20

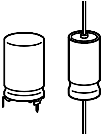

B43693 / B43793

High Voltage – 125 °C

Useful life

depending on ambient temperature T_A under ripple current operating conditions at $U_R^{1)}$

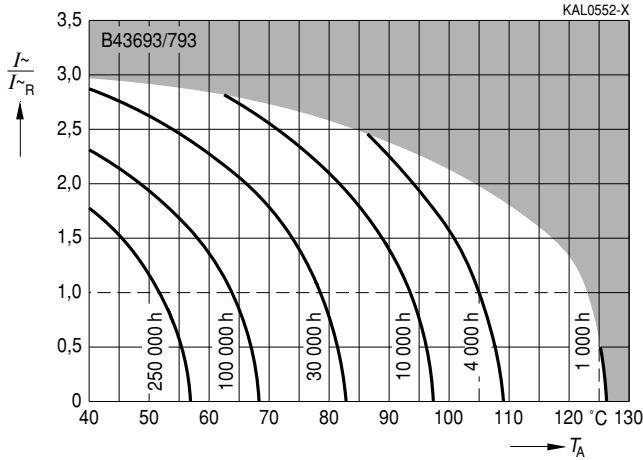

Useful life

depending on case temperature T_C under ripple current operating conditions at $U_R^{1)}$

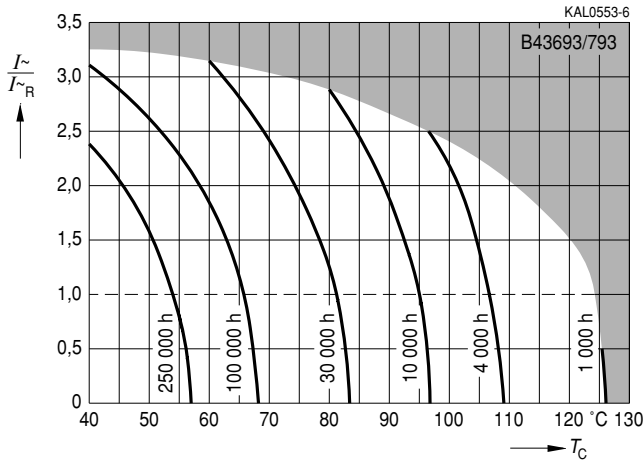

1) Refer to page 40 for an explanation on how to interpret the useful life graphs.

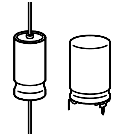

Frequency factor of permissible ripple current I_r versus frequency f

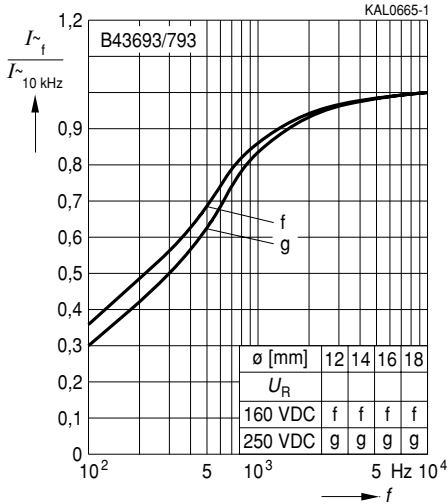

Frequency characteristics of ESR at different temperatures typical behavior

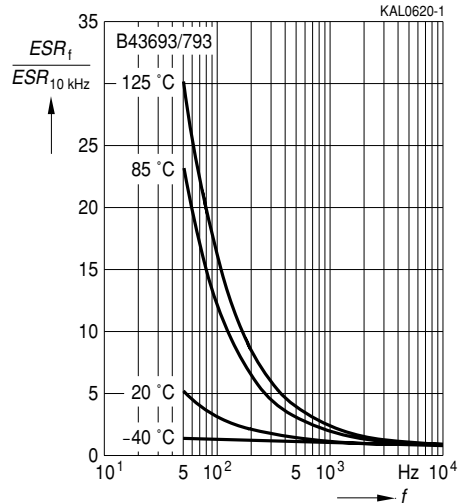

Equivalent series resistance ESR versus frequency f at different temperatures Typical behavior for 47 μ F/250 V

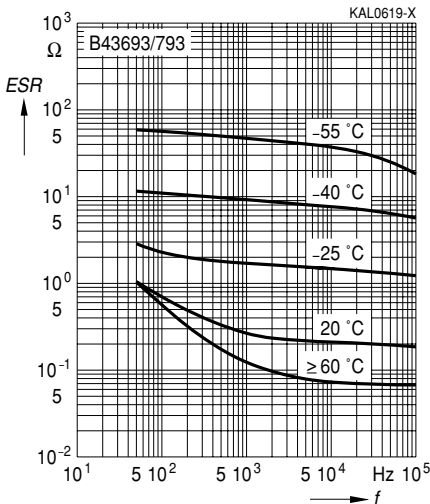

Impedance Z versus frequency f at different temperatures Typical behavior for 47 μ F/250 V

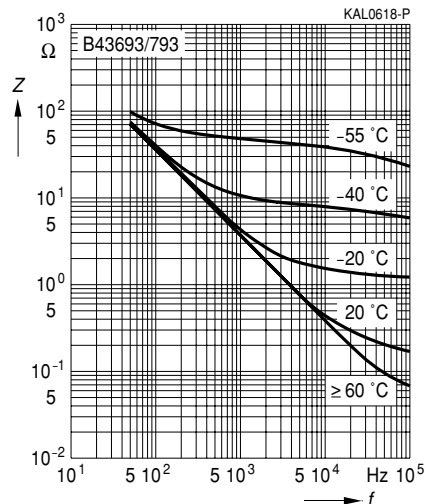

Herausgegeben von EPCOS AG

Unternehmenskommunikation, Postfach 80 17 09, 81617 München, DEUTSCHLAND

☎ ++49 89 636 09, FAX (0 89) 636-2 26 89

© EPCOS AG 2002. Vervielfältigung, Veröffentlichung, Verbreitung und Verwertung dieser Broschüre und ihres Inhalts ohne ausdrückliche Genehmigung der EPCOS AG nicht gestattet.

Bestellungen unterliegen den vom ZVEI empfohlenen Allgemeinen Lieferbedingungen für Erzeugnisse und Leistungen der Elektroindustrie, soweit nichts anderes vereinbart wird.

Diese Broschüre ersetzt die vorige Ausgabe.

Fragen über Technik, Preise und Liefermöglichkeiten richten Sie bitte an den Ihnen nächstgelegenen Vertrieb der EPCOS AG oder an unsere Vertriebsgesellschaften im Ausland. Bauelemente können aufgrund technischer Erfordernisse Gefahrstoffe enthalten. Auskünfte darüber bitten wir unter Angabe des betreffenden Typs ebenfalls über die zuständige Vertriebsgesellschaft einzuholen.

Published by EPCOS AG

Corporate Communications, P.O. Box 80 17 09, 81617 Munich, GERMANY

☎ ++49 89 636 09, FAX (0 89) 636-2 26 89

© EPCOS AG 2002. Reproduction, publication and dissemination of this brochure and the information contained therein without EPCOS' prior express consent is prohibited.

Purchase orders are subject to the General Conditions for the Supply of Products and Services of the Electrical and Electronics Industry recommended by the ZVEI (German Electrical and Electronic Manufacturers' Association), unless otherwise agreed.

This brochure replaces the previous edition.

For questions on technology, prices and delivery please contact the Sales Offices of EPCOS AG or the international Representatives.

Due to technical requirements components may contain dangerous substances. For information on the type in question please also contact one of our Sales Offices.