

Features

- Precision reference voltage
AP431: 2.495V ± 1%
AP431A: 2.495V ± 0.5%
- Sink current capability: 200mA
- Minimum cathode current for regulation: 300µA
- Equivalent full-range temp coefficient: 30 ppm/°C
- Fast turn-on response
- Low dynamic output impedance: 0.2Ω
- Programmable output voltage to 36V
- Low output noise
- Packages: SOT23, SOT23R, SOT25, SOT89-3L, SC59, SC59R, SOP-8L and TO92-3L
- Lead Free packages: SOT25, SOT89-3L, SC59, SC59R and TO92-3L
- SOP-8L, SOT23, SOT23R, SC59, SC59R: Available in "Green" Molding Compound (No Br, Sb) (Note 2)
- Lead Free Finish/ RoHS Compliant (Note 3)

General Description

The AP431 and AP431A are 3-terminal adjustable precision shunt regulators with guaranteed temperature stability over the applicable extended commercial temperature range. The output voltage may be set at any level greater than 2.495V (V_{REF}) up to 36V merely by selecting two external resistors that act as a voltage divider network. These devices have a typical output impedance of 0.2Ω. Active output circuitry provides very sharp turn-on characteristics, making these devices excellent improved replacements for Zener diodes in many applications.

The precise (+/-) 1% Reference voltage tolerance of the AP431/AP431A make it possible in many applications to avoid the use of a variable resistor, consequently saving cost and eliminating drift and reliability problems associated with it.

Ordering Information

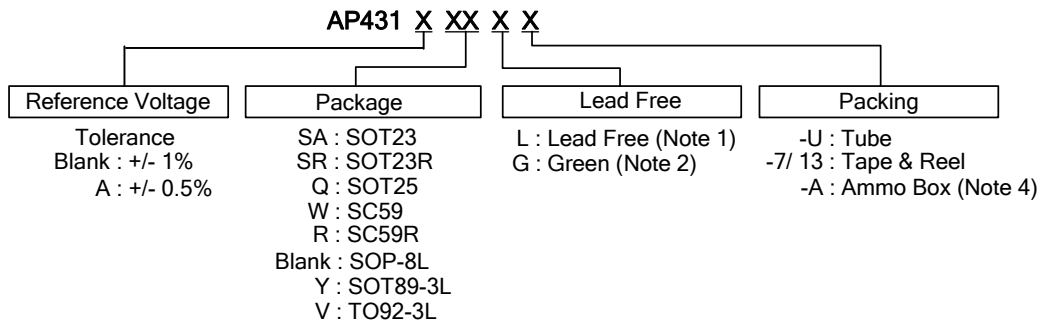

Device (Note 5)	Package Code	Packaging (Note 3, 6)	7" Tape and Reel		13" Tape and Reel		Ammo Box	
			Quantity	Part Number Suffix	Quantity	Part Number Suffix	Quantity	Part Number Suffix
AP431(A)SA	SA	SOT23	3000/Tape & Reel	-7	NA	NA	NA	NA
AP431(A)SR	SR	SOT23R	3000/Tape & Reel	-7	NA	NA	NA	NA
AP431(A)Q	Q	SOT25	3000/Tape & Reel	-7	NA	NA	NA	NA
AP431(A)W	W	SC59	3000/Tape & Reel	-7	NA	NA	NA	NA
AP431(A)R	R	SC59R	3000/Tape & Reel	-7	NA	NA	NA	NA
AP431(A)		SOP-8L	NA	NA	2500/Tape & Reel	-13	NA	NA
AP431(A)Y	Y	SOT89-3L	NA	NA	2500/Tape & Reel	-13	NA	NA
AP431(A)V	V	TO92-3L	NA	NA	NA	NA	2000/Box	-A

- Notes:
1. SOT25, SOT89-3L and TO92-3L are "Lead Free" products only.
 2. SOP-8L, SOT23 and SOT23R are available in "Green" product only.
 3. RoHS revision 13.2.2003. Glass and high temperature solder exemptions applied, see *EU Directive Annex Notes 5 and 7*
 4. Ammo Box is for TO92-3L Spread Lead.
 5. Suffix "A" denotes AP431A device.
 6. Pad layout as shown on Diodes Inc. suggested pad layout document AP02001, which can be found on our website at <http://www.diodes.com/datasheets/ap02001.pdf>.

Pin Assignment

(1) SOT25

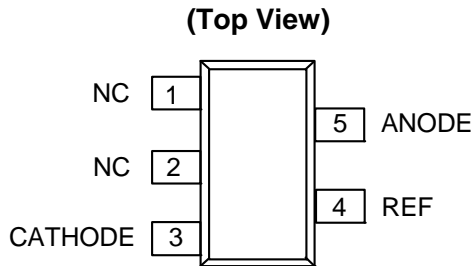

(2) SOP-8L

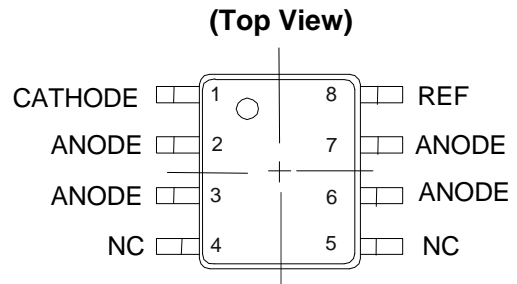

(3) SC59

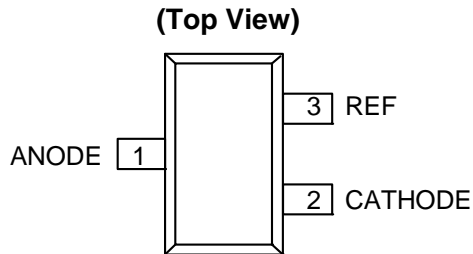

(4) SC59R

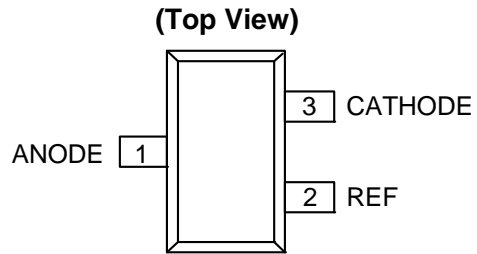

(5) SOT23

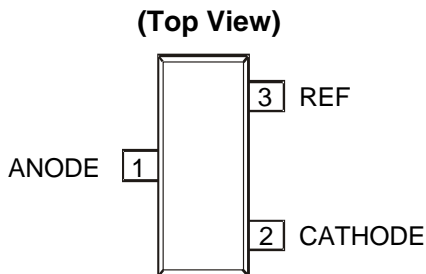

(6) SOT23R

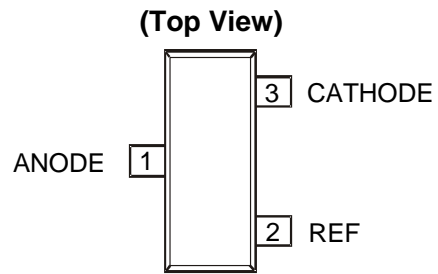

(7) SOT89-3L

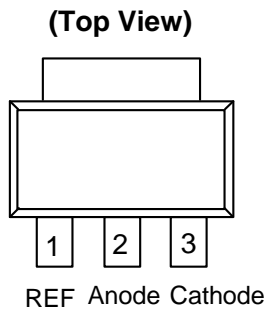

(8) TO92-3L

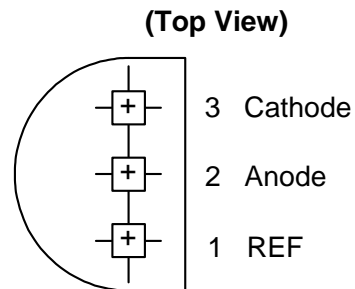

Typical Application Circuit

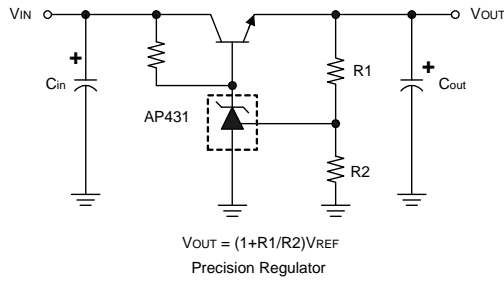

Block Diagram

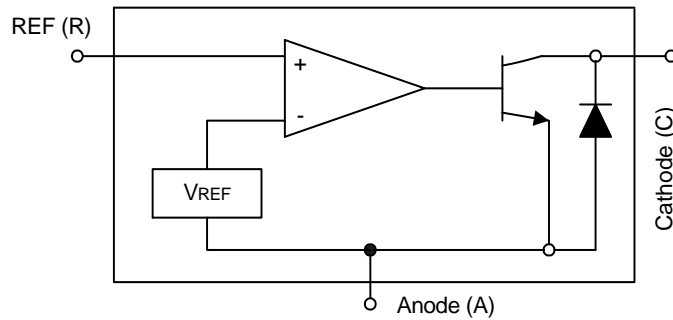

Symbol

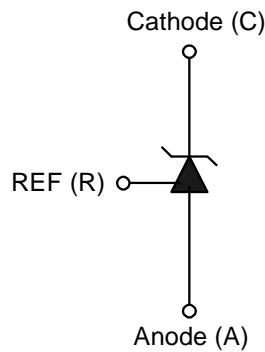

Absolute Maximum Ratings

Symbol	Parameter	Rating	Unit	
V _{CV}	Cathode Voltage	+36	V	
I _{CC}	Continuous Cathode Current	-10 to +250	mA	
I _{REF}	Reference Input Current	10	mA	
T _{OP}	Operating Temperature	-20 to +85	°C	
T _{ST}	Storage Temperature	-65 to +150	°C	
P _D	Power Dissipation (Notes 7, 8)	SOT23(R)	400	mW
		SOT25	550	mW
		SC59(R)	400	mW
		SOP-8L	600	mW
		SOT89-3L	800	mW
		TO92-3L	780	mW

Notes: 7. T_J, max =150°C.
8. Ratings apply to ambient temperature at 25°C.

Electrical Characteristics (T_A = 25°C, V⁺ = +5.0V, unless otherwise stated)

Symbol	Parameter	Test Conditions	Min	Typ.	Max	Unit
$\overline{V_{REF}}$	Reference voltage	V _{KA} = V _{REF} , I _{KA} = 10mA (Fig.1)	AP431 AP431A	2.470 2.482	2.495 2.507	V
V _{REF}	Deviation of Reference input voltage over temperature (Note 9)	V _{KA} = V _{REF} , I _{KA} = 10mA, T _a = Full range (Fig.1)	—	8.0	20	mV
$\frac{\Delta V_{REF}}{\Delta V_{KA}}$	Ratio of the change in Reference voltage to the change in Cathode voltage	I _{KA} = 10mA (Fig. 2)	V _{KA} = V _{REF} to 10V V _{KA} = 10V to 36V	— -1	-2.0 -2	mV/V mV/V
I _{REF}	Reference input current	R1 = 10KΩ, R2 = ∞ I _{KA} = 10mA (Fig. 2)	—	1.4	3.5	μA
αI _{REF}	Deviation of Reference input current over temperature	R1 = 10KΩ, R2 = ∞ I _{KA} = 10mA T _a = Full range (Fig. 2)	—	0.4	1.2	μA
I _{KA(MIN)}	Minimum Cathode current for regulation	V _{KA} = V _{REF} (Fig.1)	—	0.19	0.5	mA
I _{KA(OFF)}	Off-state current	V _{KA} = 36V, V _{REF} = 0V (Fig. 3)	—	0.1	1.0	μA
Z _{KA}	Dynamic output impedance (Note 10)	V _{KA} = V _{REF} V _{KA} = V _{REF} ΔI _{KA} = 0.1mA ~ 15mA Frequency ≤ 1KHz (Fig.1)	—	0.2	0.5	Ω

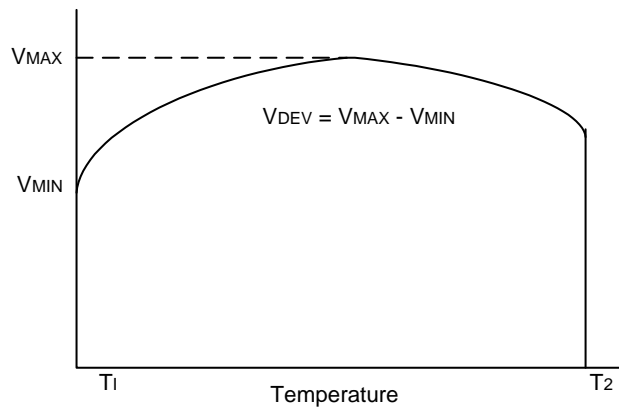

Notes: 9. Deviation of reference input voltage, V_{DEV}, is defined as the maximum variation of the reference over the full temperature range. The average temperature coefficient of the reference input voltage αV_{REF} is defined as:

$$|\alpha V_{REF}| = \frac{\left(\frac{V_{DEV}}{V_{REF}(25^\circ C)}\right) \cdot 10^6}{T_2 - T_1} \dots\dots\dots (\text{ppm}/^\circ C)$$

Where:
T₂ - T₁ = full temperature change.
αV_{REF} can be positive or negative depending on whether the slope is positive or negative.

Notes: 10. The dynamic output impedance, R_z, is defined as:

$$|Z_{KA}| = \frac{\Delta V_{KA}}{\Delta I_{KA}}$$

When the device is programmed with two external resistors R1 and R2 (see Figure 2.), the dynamic output impedance of the overall circuit, is defined as:

$$|Z_{KA}'| = \frac{\Delta V}{\Delta i} \approx |Z_{KA}| \left(1 + \frac{R1}{R2}\right)$$

Test Circuits

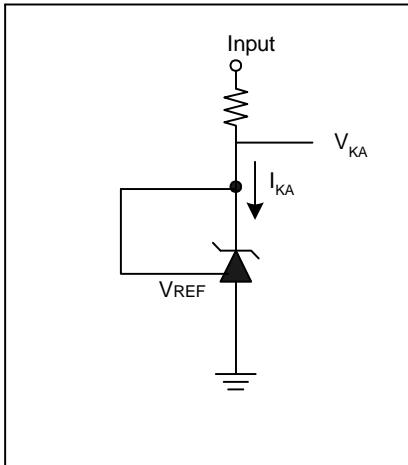

Fig 1. Test Circuit for $V_{KA} = V_{REF}$

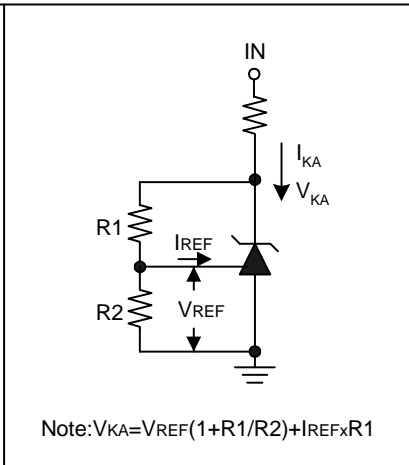

Fig 2. Test Circuit for $V_{KA} > V_{REF}$

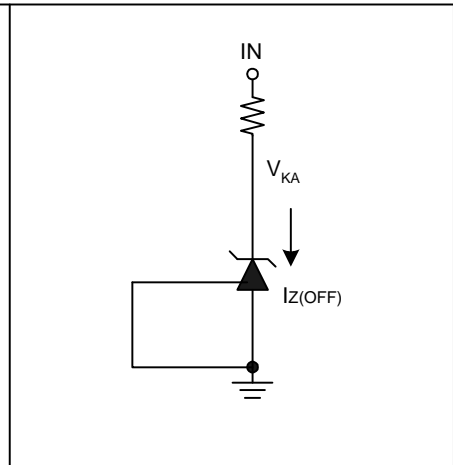
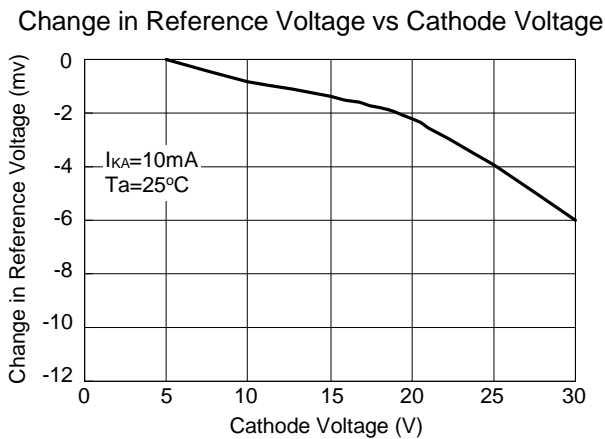
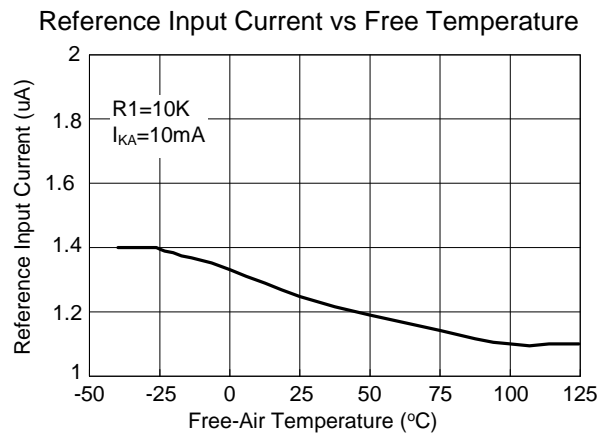
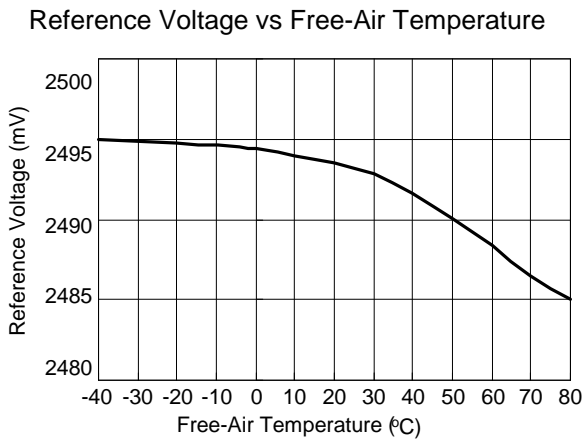
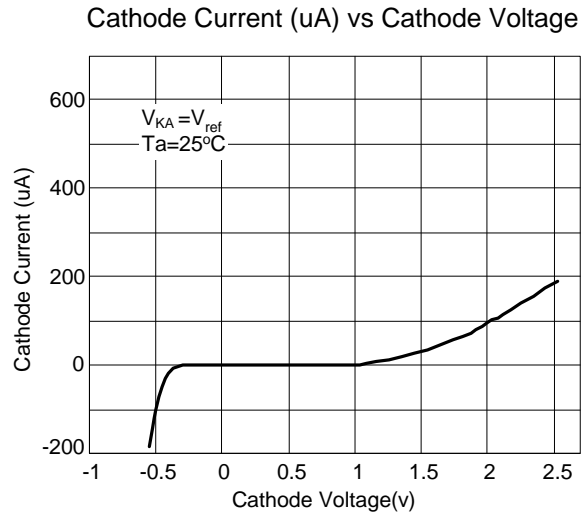
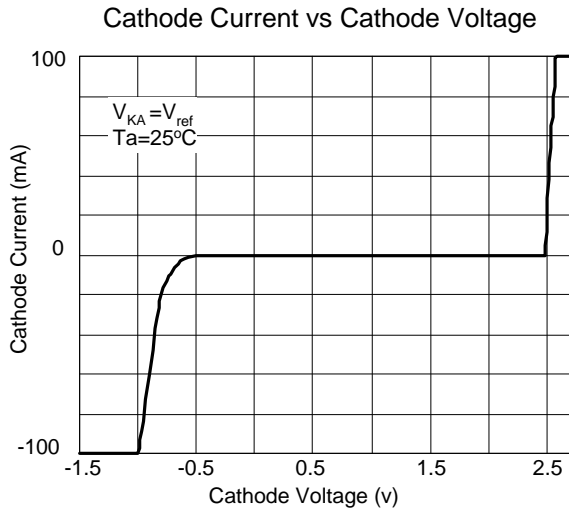

Fig 3. Test Circuit for Off-State Current

Typical Performance Characteristics



Typical Performance Characteristics (Continued)

Small-Signal Voltage Amplification vs Frequency

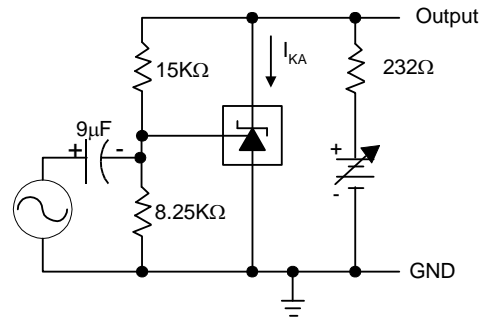
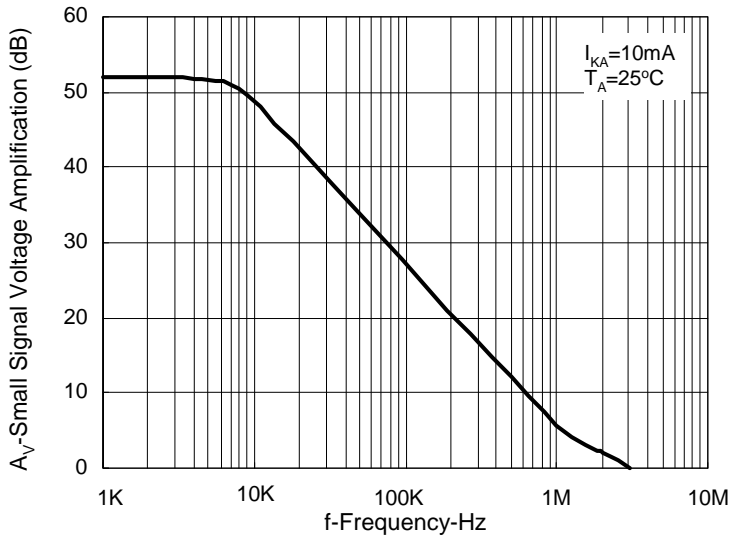

Test Circuit for Voltage Amplification

Reference Impedance vs Frequency

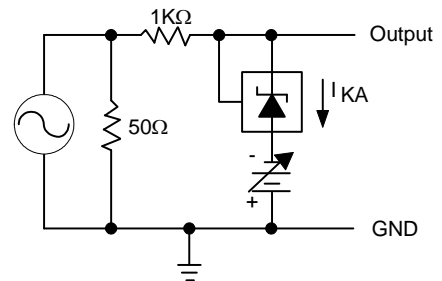
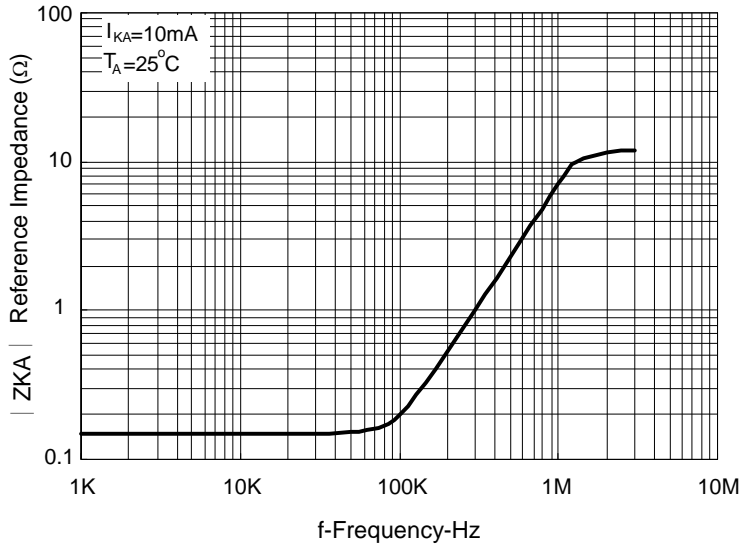

Test Circuit for Reference Impedance

Typical Performance Characteristics (Continued)

Pulse Response

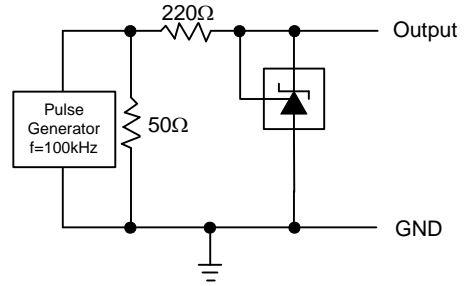
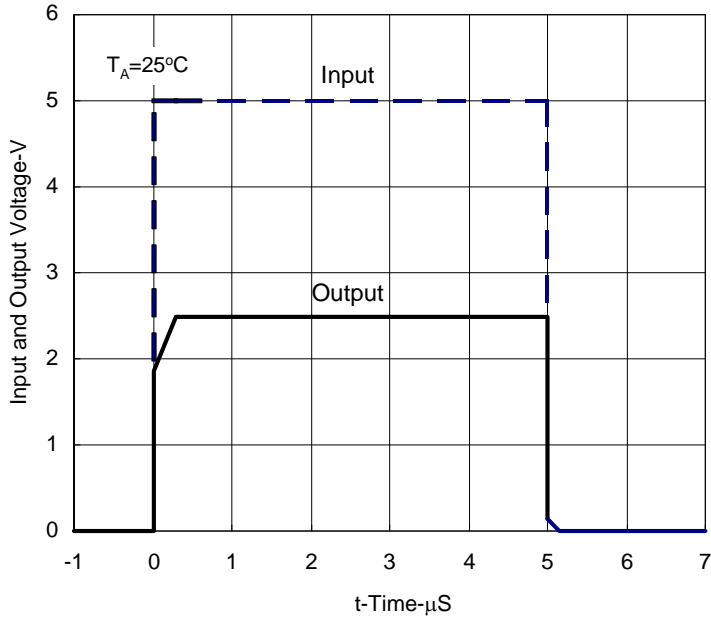

Test Circuit for Pulse Response

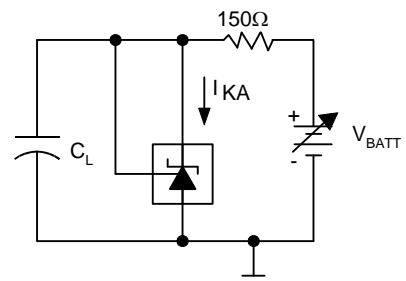
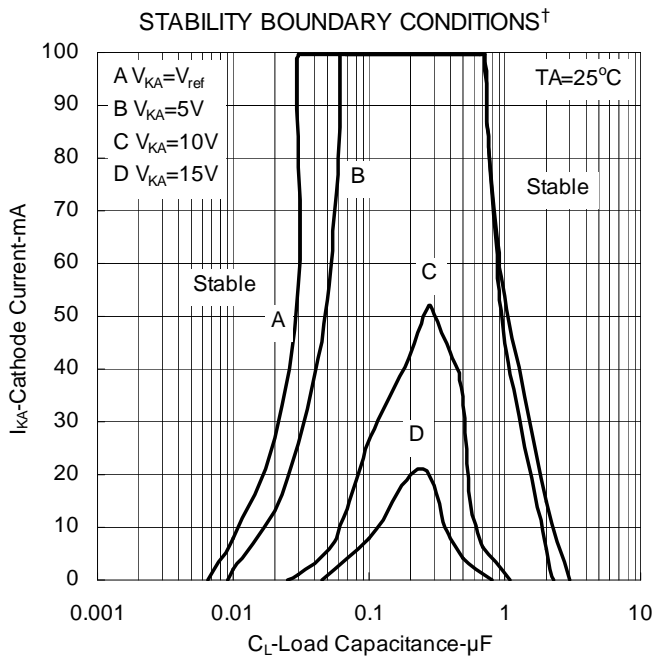

Test Circuit for Curve A

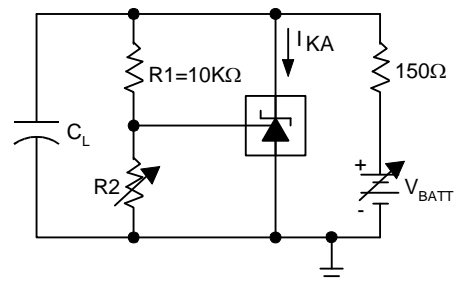

Test Circuit for Curve B, C, and D

[†]The areas under the curves represent conditions that may cause the device to oscillate. For curves B, C, and D, R2 and V+ were adjusted to establish the initial V_{KA} and I_{KA} conditions with $C_L=0$. V_{BATT} and C_L were then adjusted to determine the ranges of stability.

Application Examples

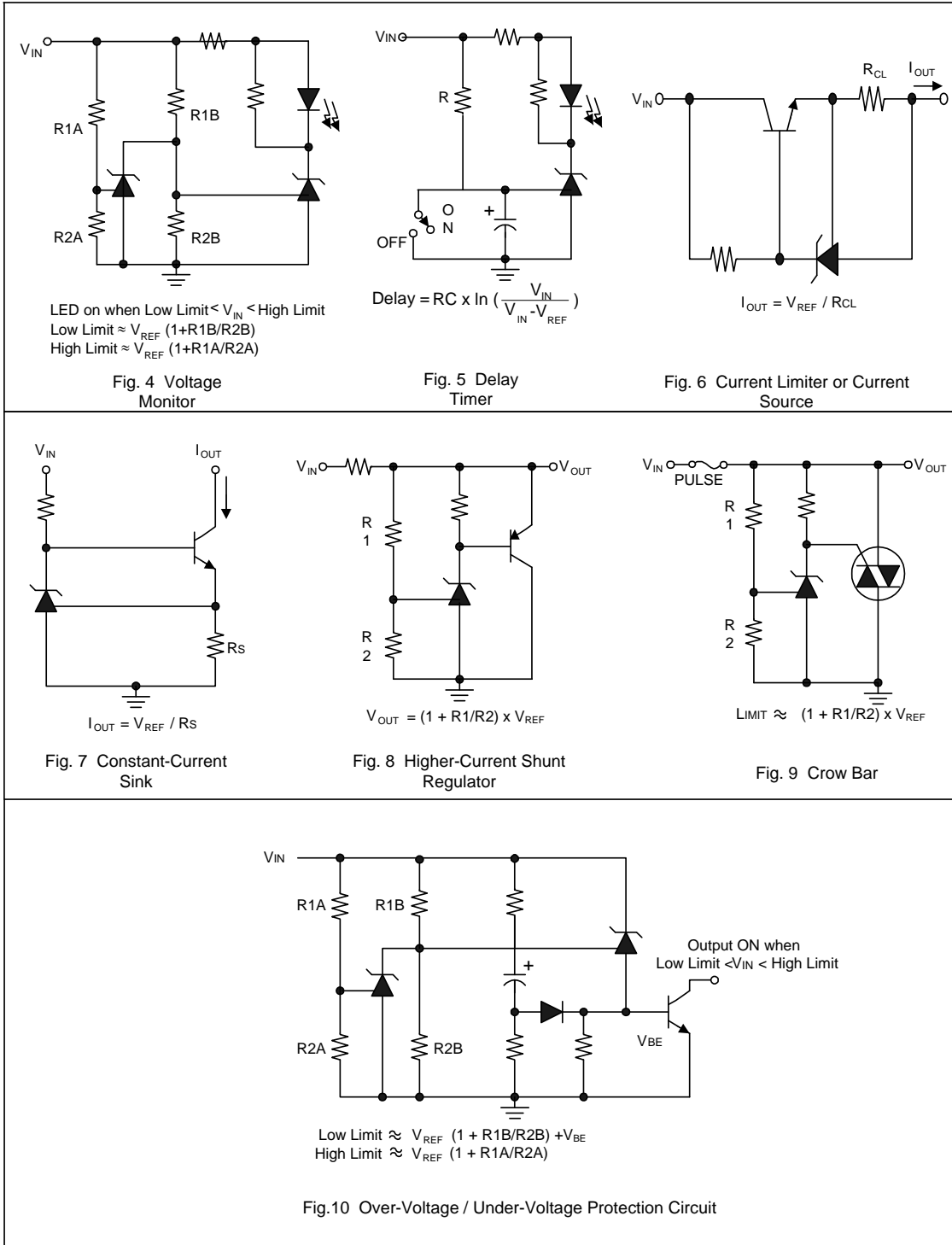

Marking Information

(1) SC59 and SC59R

(Top View)

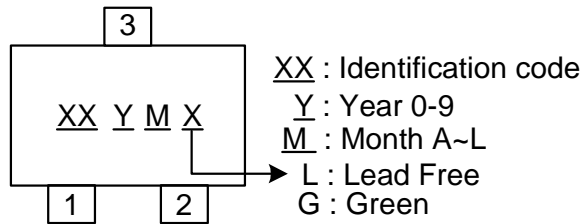

(2) SOT23 and SOT23R

(Top View)

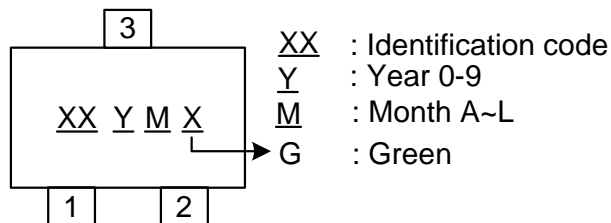

(3) SOT25

(Top View)

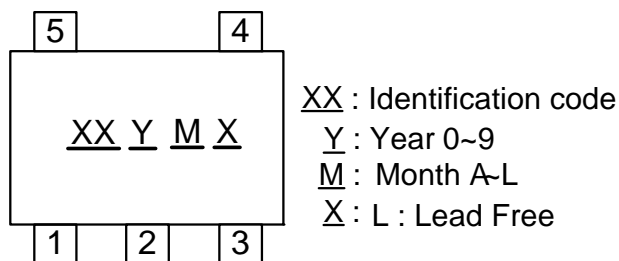

Marking Information (Continued)

(4) SOP-8L

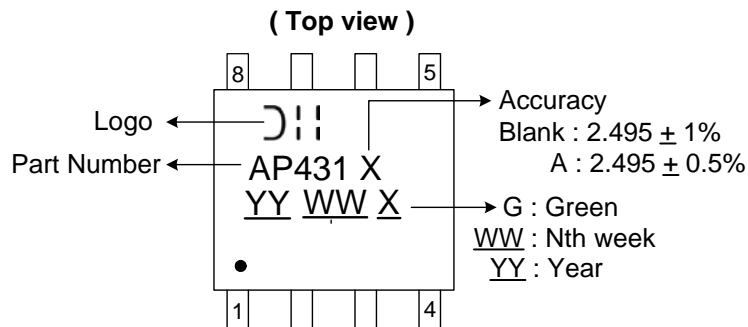

(5) SOT89-3L

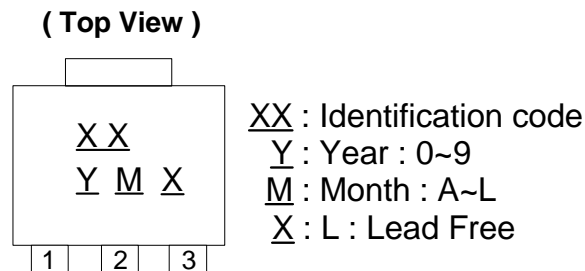

(6) TO92-3L

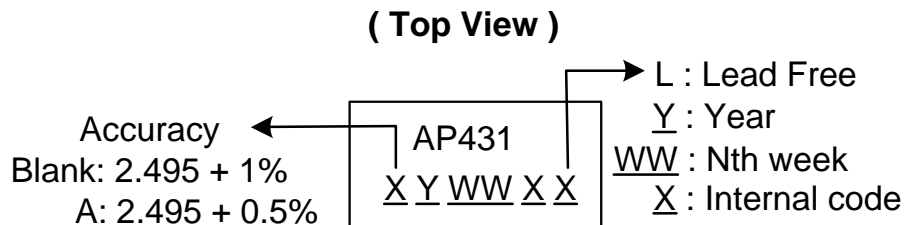

Identification Code Table

Device	Package (Note 11)	Identification Code	Date Code
AP431SA	SOT23	D1	YM
AP431ASA	SOT23	D2	YM
AP431SR	SOT23R	D5	YM
AP431ASR	SOT23R	D6	YM
AP431Q	SOT25	A2	YM
AP431AQ	SOT25	A3	YM
AP431W	SC59	A6	YM
AP431AW	SC59	A7	YM
AP431R	SC59	A8	YM
AP431AR	SC59	A9	YM
AP431Y	SOT89-3L	A4	YM
AP431AY	SOT89-3L	A5	YM

Notes: 11. For Packaging Details, go to our website at <http://www.diodes.com/datasheets/ap02007.pdf>.

Package Information (All Dimensions in mm)

(1) Package type: SOT25

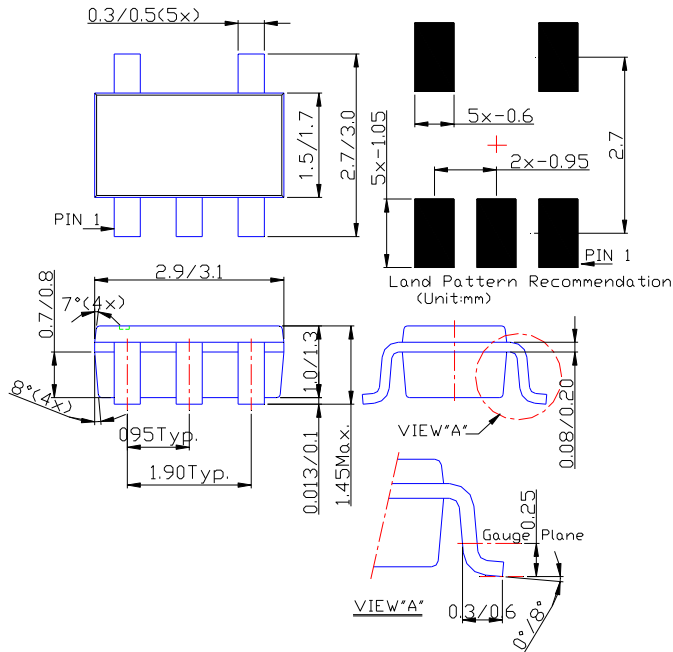

(2) Package Type: SC59 and SC59R

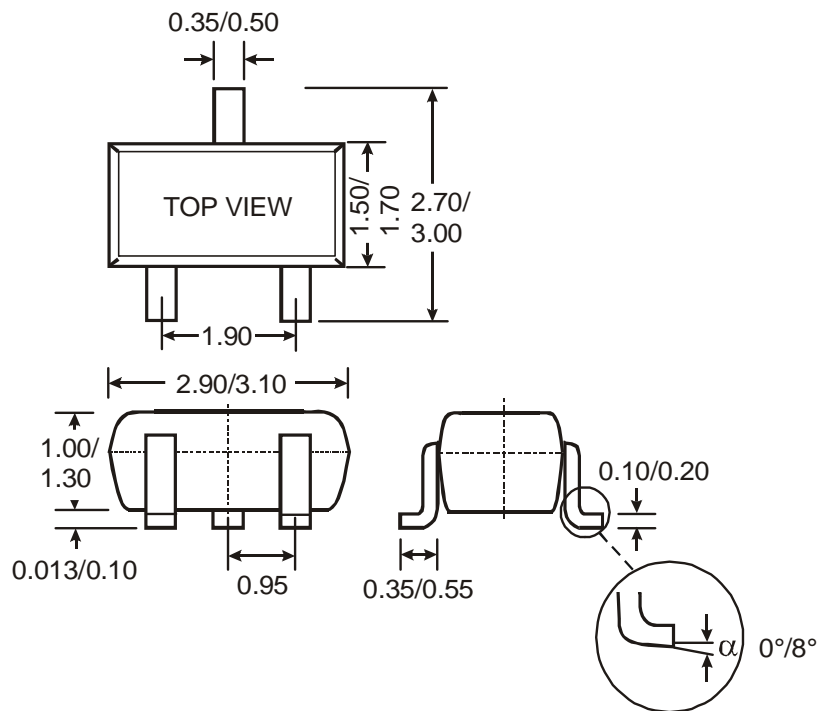

Package Information (Continued)

(3) Package Types: SOT23 and SOT23R

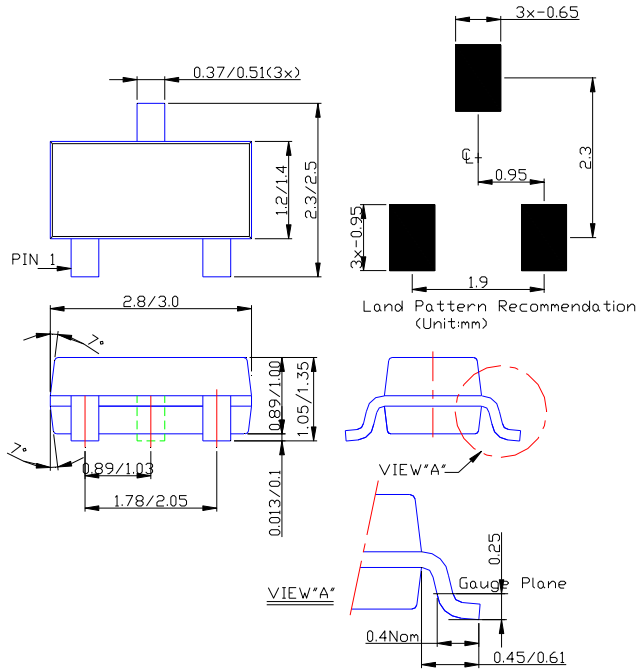

(4) Package Type: SOP-8L

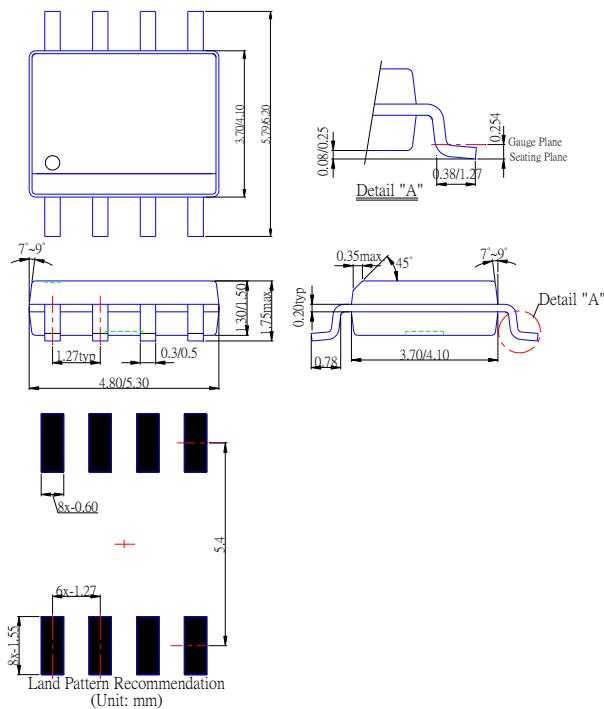

Package Information (Continued)

(5) Package Type: SOT89-3L

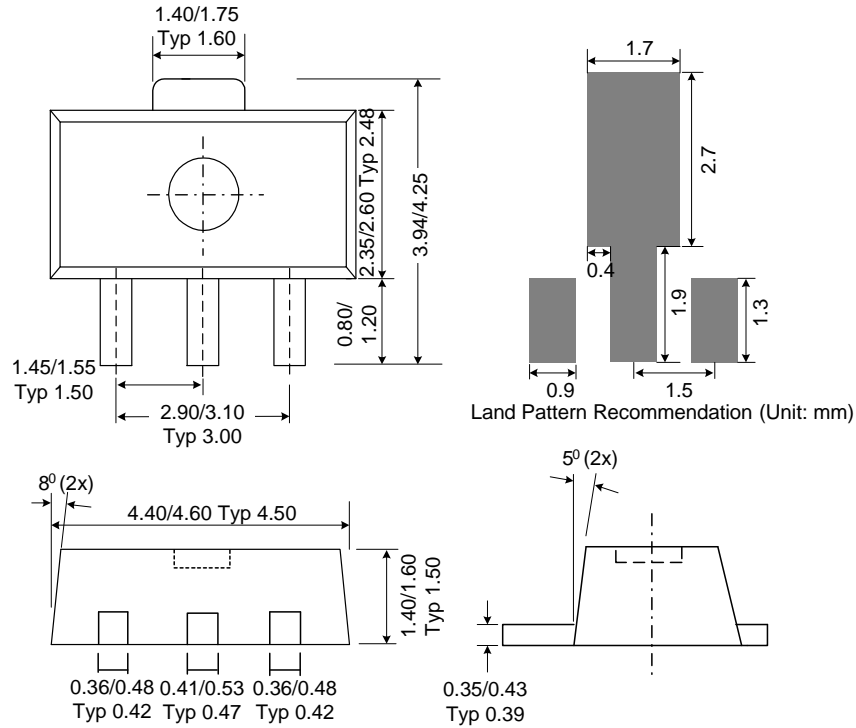

(6) Package Type: TO92-3L for Ammo pack

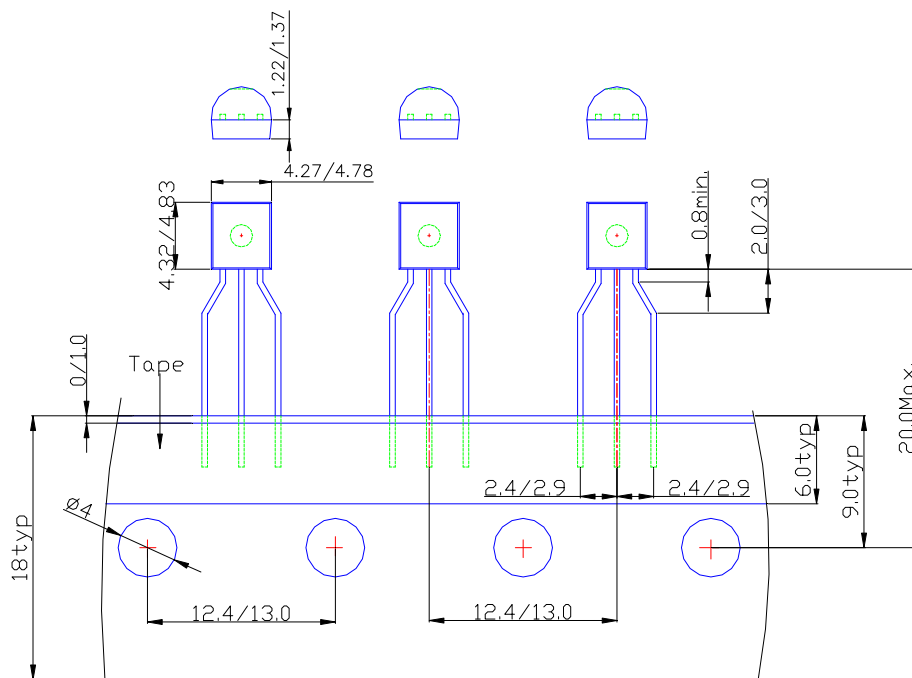

IMPORTANT NOTICE

Diodes Incorporated and its subsidiaries reserve the right to make modifications, enhancements, improvements, corrections or other changes without further notice to any product herein. Diodes Incorporated does not assume any liability arising out of the application or use of any product described herein; neither does it convey any license under its patent rights, nor the rights of others. The user of products in such applications shall assume all risks of such use and will agree to hold Diodes Incorporated and all the companies whose products are represented on our website, harmless against all damages.

LIFE SUPPORT

Diodes Incorporated products are not authorized for use as critical components in life support devices or systems without the expressed written approval of the President of Diodes Incorporated.