

### Multi DomiLED<sup>TM</sup>

Synonymous with function and performance, the Multi DomiLED<sup>TM</sup> series is perfectly suited for a variety of cross-industrial applications due to its small package outline, durability and superior brightness.

### Features:

- > High brightness bi-color surface mount LED.
- > 120° viewing angle.
- > Small package outline (LxWxH) of 3.2 x 2.8 x 1.8mm.
- > Qualified according to JEDEC moisture sensitivity Level 2.
- > Compatible to IR reflow soldering.
- > Environmental friendly; RoHS compliance.

### Applications:

- > Automotive: interior applications, eg: switches, telematics, climate control system, dashboard, etc.
- > Display: full color display video notice board.
- > Industrial: white goods (eg: Oven, microwave, etc.).

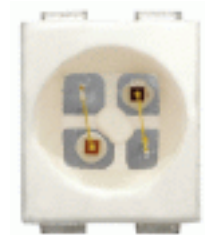

**Optical Characteristics at Tj=25°C**

Part Ordering Number	Color, $\lambda_{dom}$ (nm)		Viewing Angle°	Luminous Intensity @ IF = 20mA IV (mcd)					
	Chip #1	Chip #2		Chip #1			Chip #2		
				Min.	Typ.	Max.	Min.	Typ.	Max.
DMRY-GJS-LM+LM-1	Red, 625nm	Yellow, 587nm	120	11.2	18.0	28.5	11.2	18.0	28.5
●DMRG-GJS-LM+LM-1	Red, 625nm	Green, 570nm	120	11.2	18.0	28.5	11.2	18.0	28.5
DMRG-GJS-LM+MN-1	Red, 625nm	Green, 570nm	120	11.2	18.0	28.5	18.0	28.5	45.0
●DMYG-GJS-LM+LM-1	Yellow, 587nm	Green, 570nm	120	11.2	18.0	28.5	11.2	18.0	28.5
DMYG-GJS-LM+MN-1	Yellow, 587nm	Green, 570nm	120	11.2	18.0	28.5	18.0	28.5	45.0

● Not for new design

NOTE

1. DMXX comes in a quantity of 2000 units per reel.
2. Luminous intensity is measured with an accuracy of ± 11%.
4. Half group binning for luminous intensity is also available upon request.

**Electrical Characteristics at Tj=25°C**

	Vf @ If = 20mA	
	Typ. (V)	Max. (V)
Red; Yellow; Green	2.2	2.5

Forward voltage, Vf is measured with an accuracy of ± 0.1 V.

**Absolute Maximum Ratings**

	Maximum Value	Unit
DC forward current	30	mA
Peak pulse current; (tp ≤ 10µs, Duty cycle = 0.005)	1000	mA
Reverse voltage	5	V
ESD threshold (HBM)	2	KV
LED junction temperature	125	°C
Operating temperature	-40 ... +100	°C
Storage temperature	-40 ... +100	°C

**Wavelength Grouping at Tj=25°C**

Color	Group	Wavelength distribution (nm)
Red	Full	620 - 635
Yellow	Full	582 - 594
	W	582 - 585
	X	585 - 588
	Y	588 - 591
	Z	591 - 594
Green	Full	564.5 - 576.5
	W	564.5 - 567.5
	X	567.5 - 570.5
	Y	570.5 - 573.5
	Z	573.5 - 576.5

Dominant wavelength is measured with an accuracy of ± 1 nm.

**Luminous Intensity Group at Tj=25°C**

Brightness Group	Luminous Intensity @ IV (mcd)	
	Chip #1	Chip #2
LL	11.2...18.0	11.2...18.0
LM	11.2...18.0	18.0...28.5
LN	11.2...18.0	28.5...45.0
ML	18.0...28.5	11.2...18.0
MM	18.0...28.5	18.0...28.5
MN	18.0...28.5	28.5...45.0

Luminous intensity is measured with an accuracy of ± 11%.

**Relative Intensity Vs Forward Current**

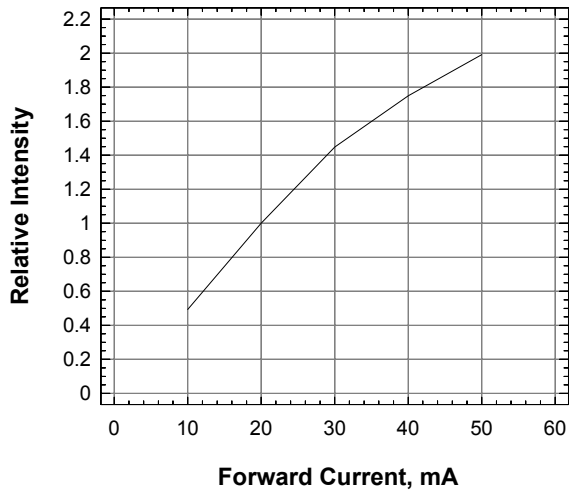

**Forward Current Vs Forward Voltage**

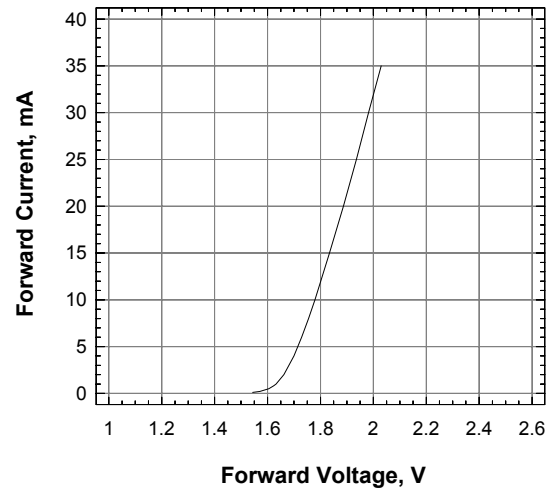

**Maximum Current Vs Temperature**

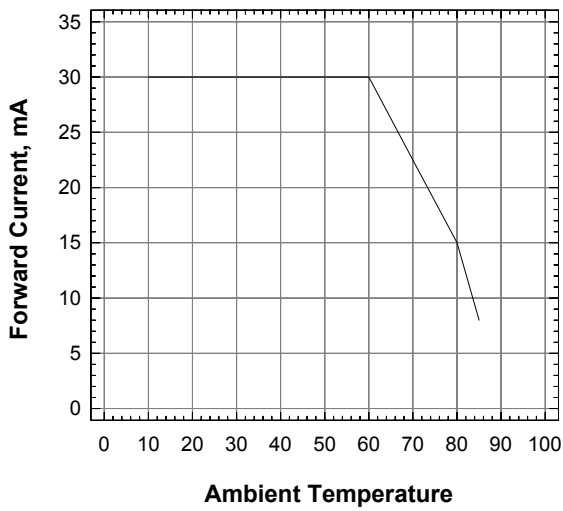

**Radiation Pattern**

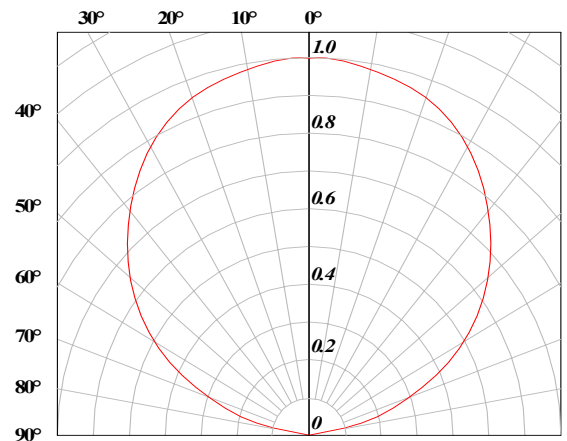

**Multi DomiLED™ • GaP : Bi-Color Package Outlines**

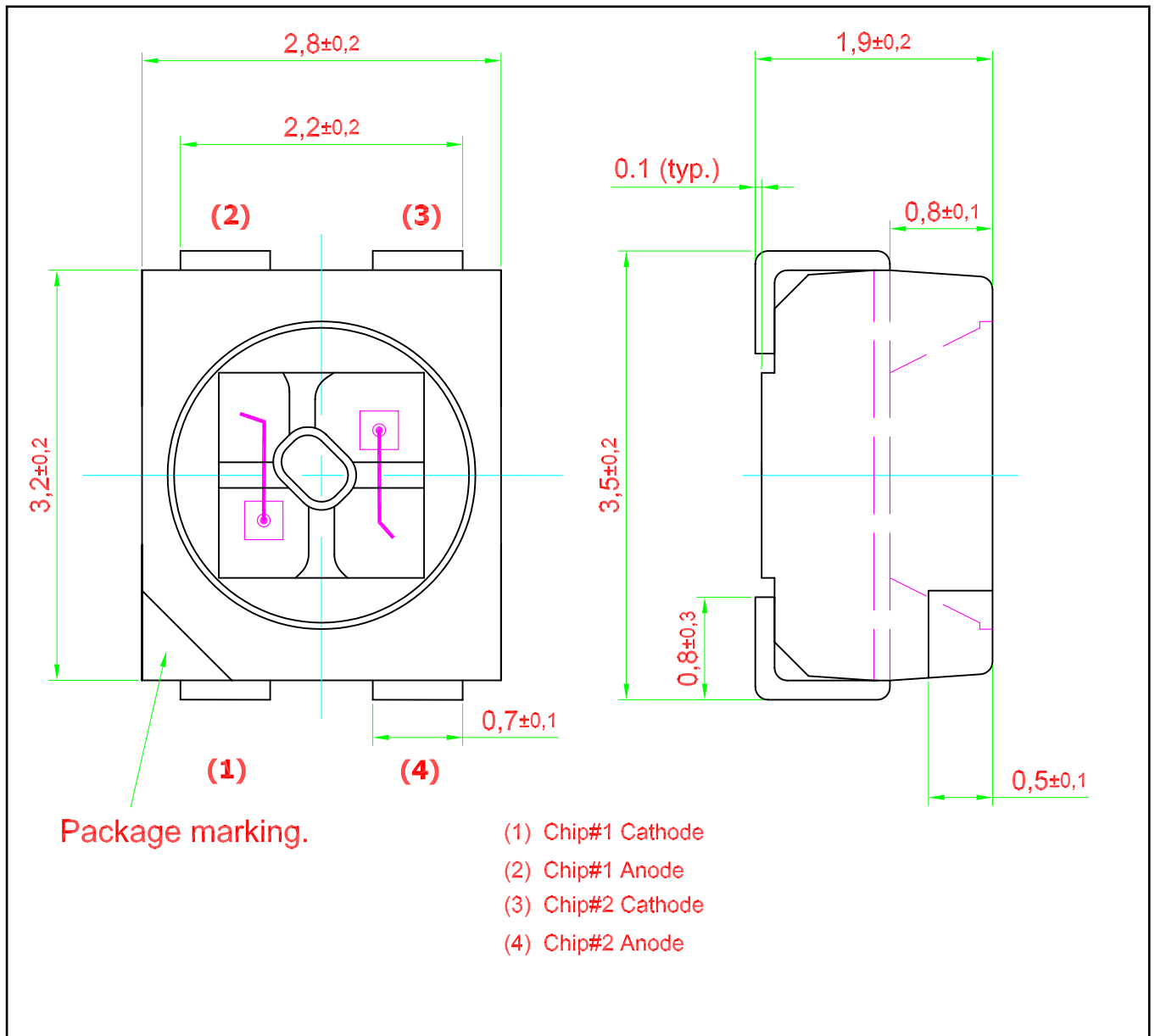

**Material**

Material	
Lead-frame	Cu Alloy With Ag Plating
Package	High Temperature Resistant Plastic, PPA
Encapsulant	Epoxy
Soldering Leads	Sn Plating

**Recommended Solder Pad**

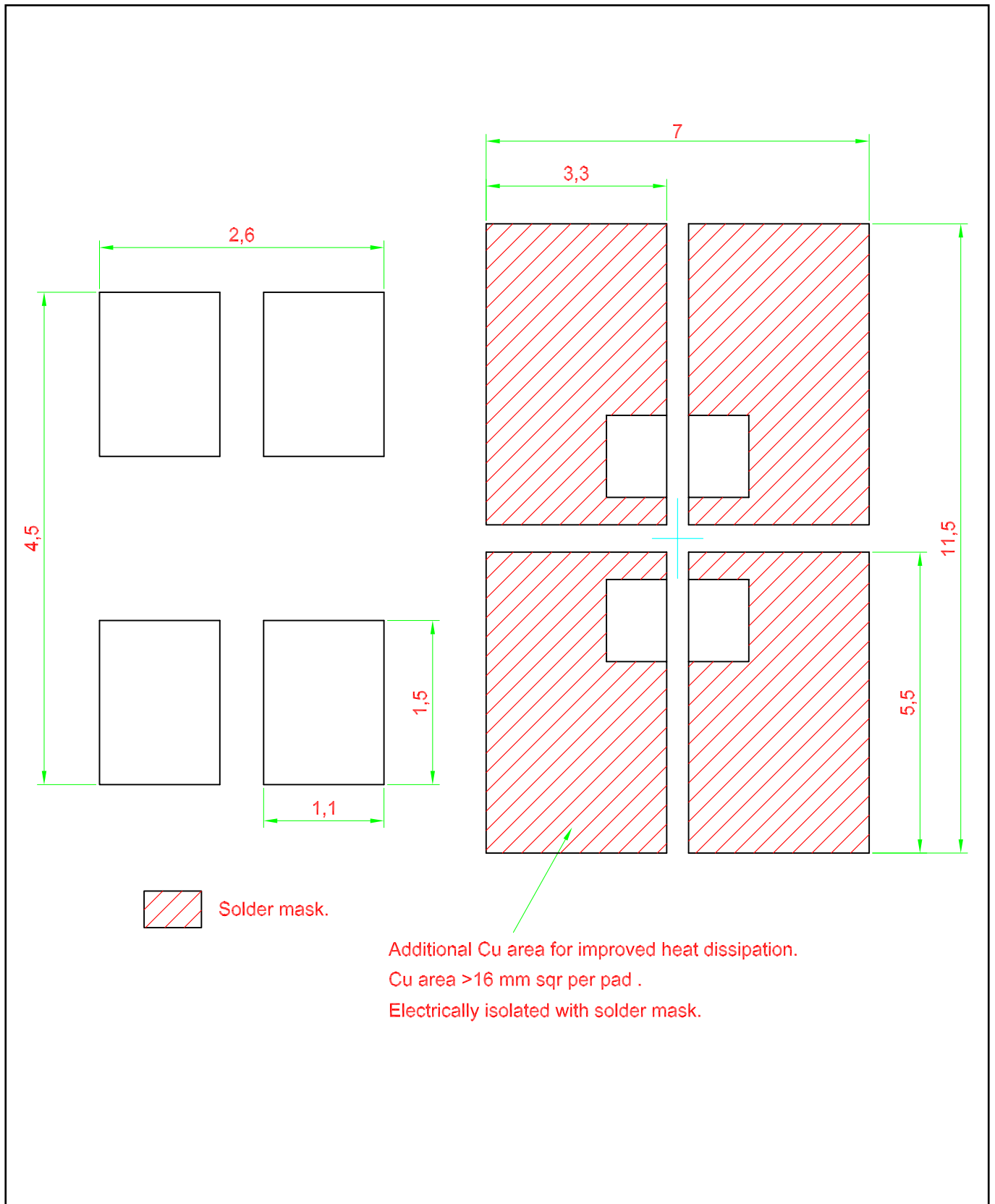

**Taping and orientation**

- Reels come in quantity of 2000 units.
- Reel diameter is 180 mm.

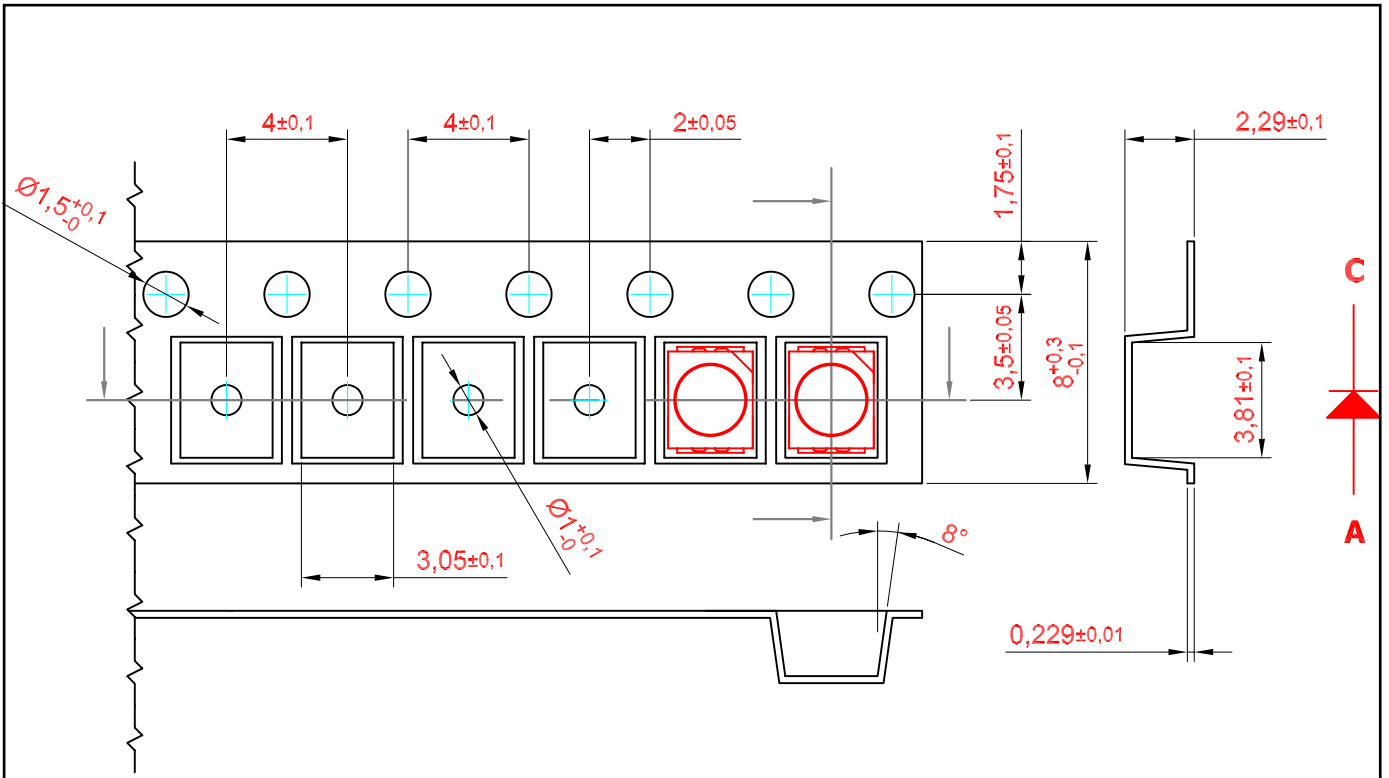

200 mm min. for Ø180 reel.  
 200 mm min. for Ø330 reel.

480 mm min. for Ø180 reel.  
 960 mm min. for Ø330 reel.

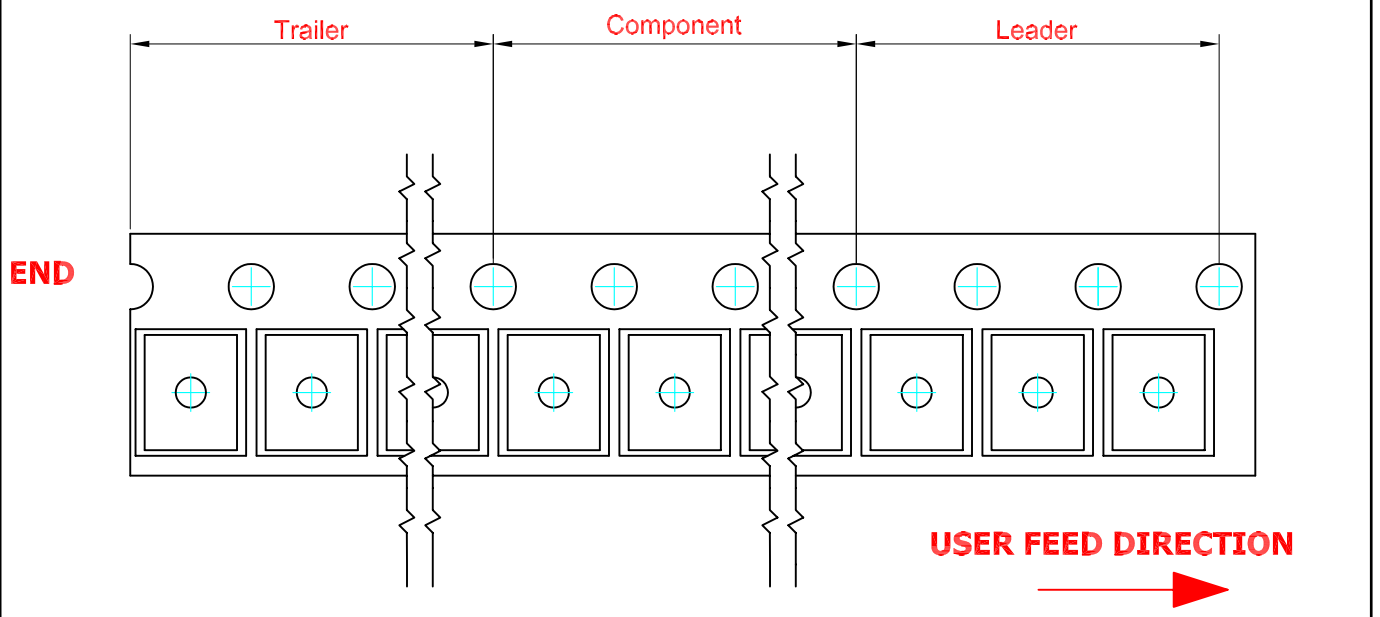

**Packaging Specification**

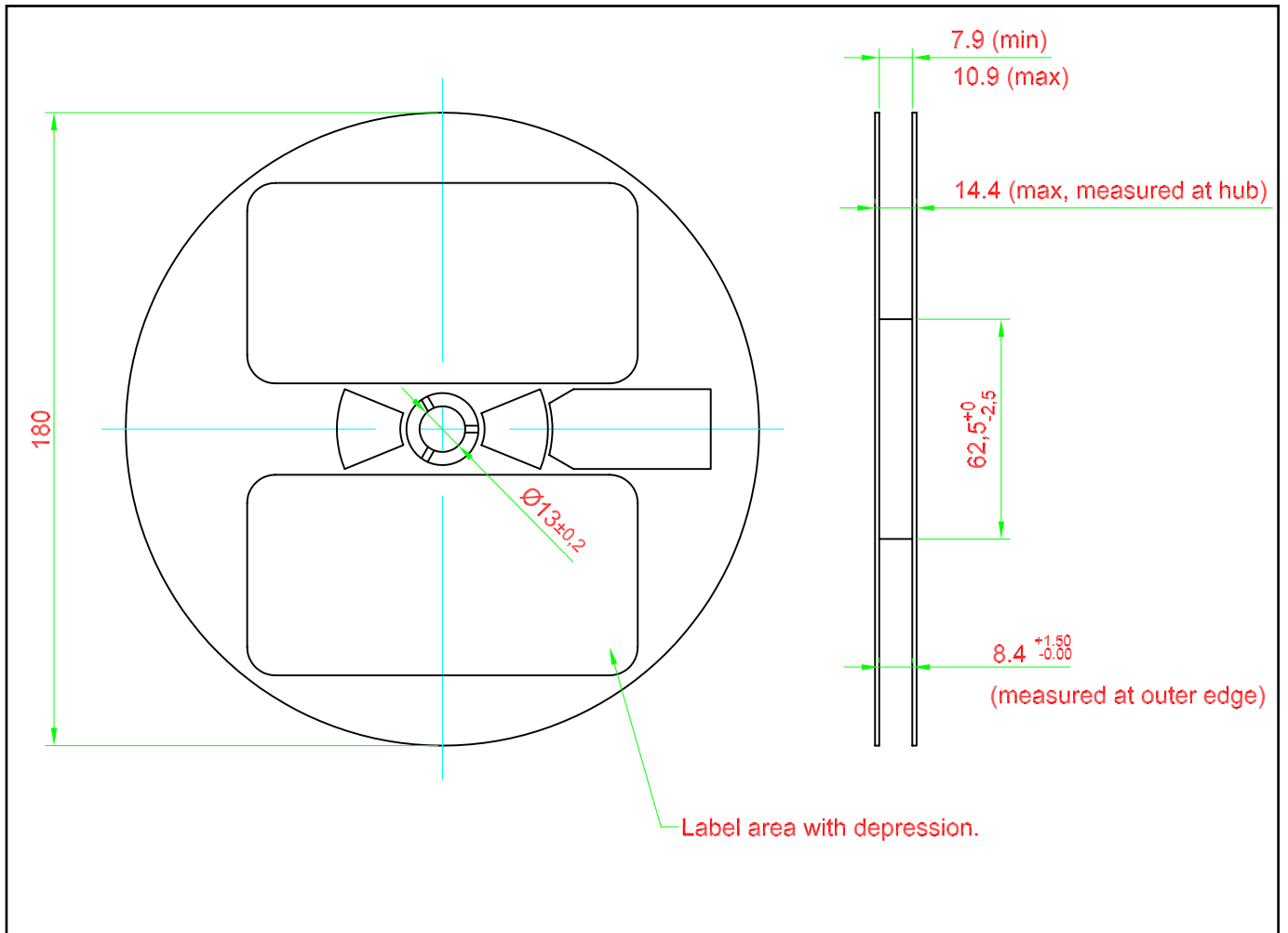



**Packaging Specification**

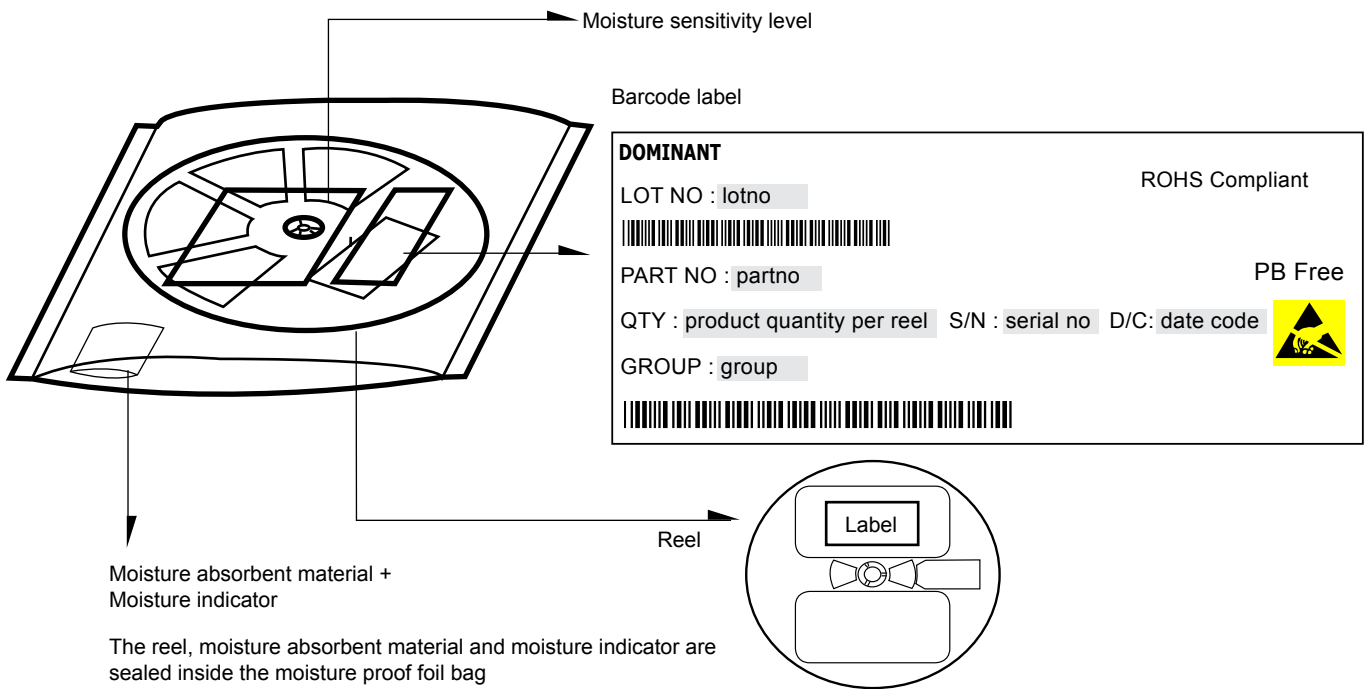

	Average 1pc DomiLED/Multi DomiLED	1 completed bag (2000pcs)
Weight (gram)	0.034	190 ± 10

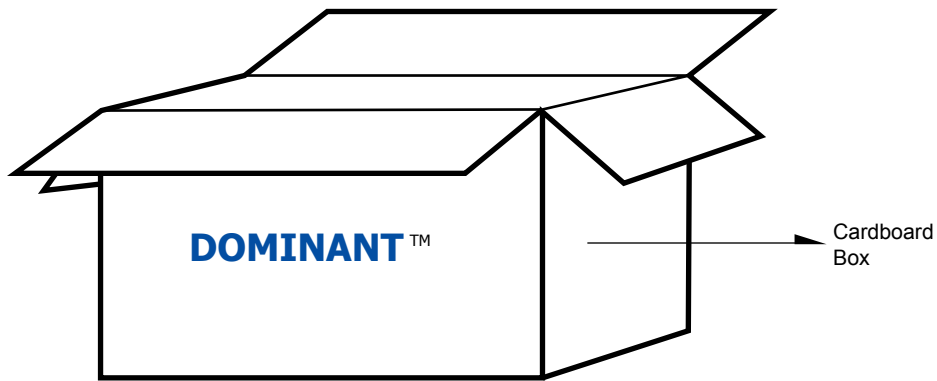

**For Multi DomiLED™**

Cardboard Box Size	Dimensions (mm)	Empty Box Weight (kg)	Reel / Box	Quantity / Box (pcs)
Small	300 x 250 x 250	0.58	15 reels MAX	30,000 MAX
Large	416 x 516 x 476	1.74	96 reels MAX	192,000 MAX

**Recommended Sn-Pb IR-Reflow Soldering Profile**

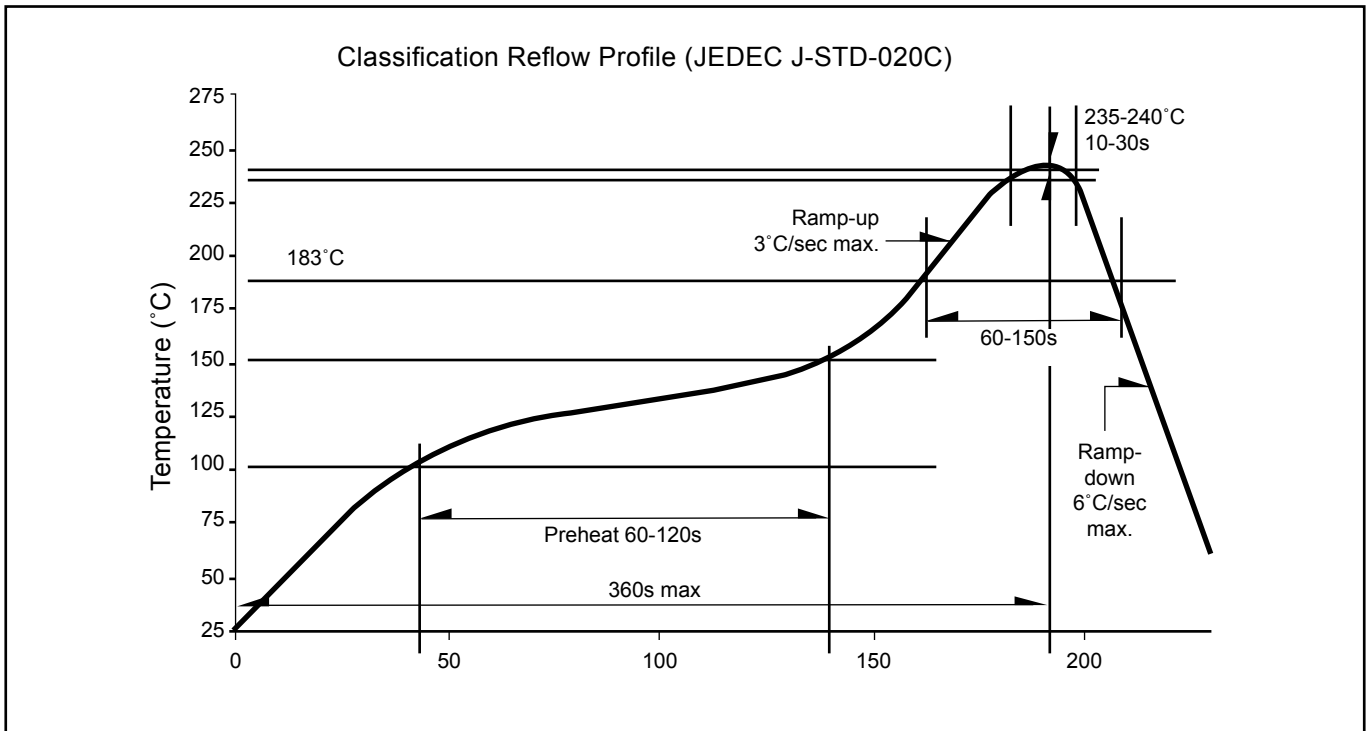

**Recommended Pb-free Soldering Profile**

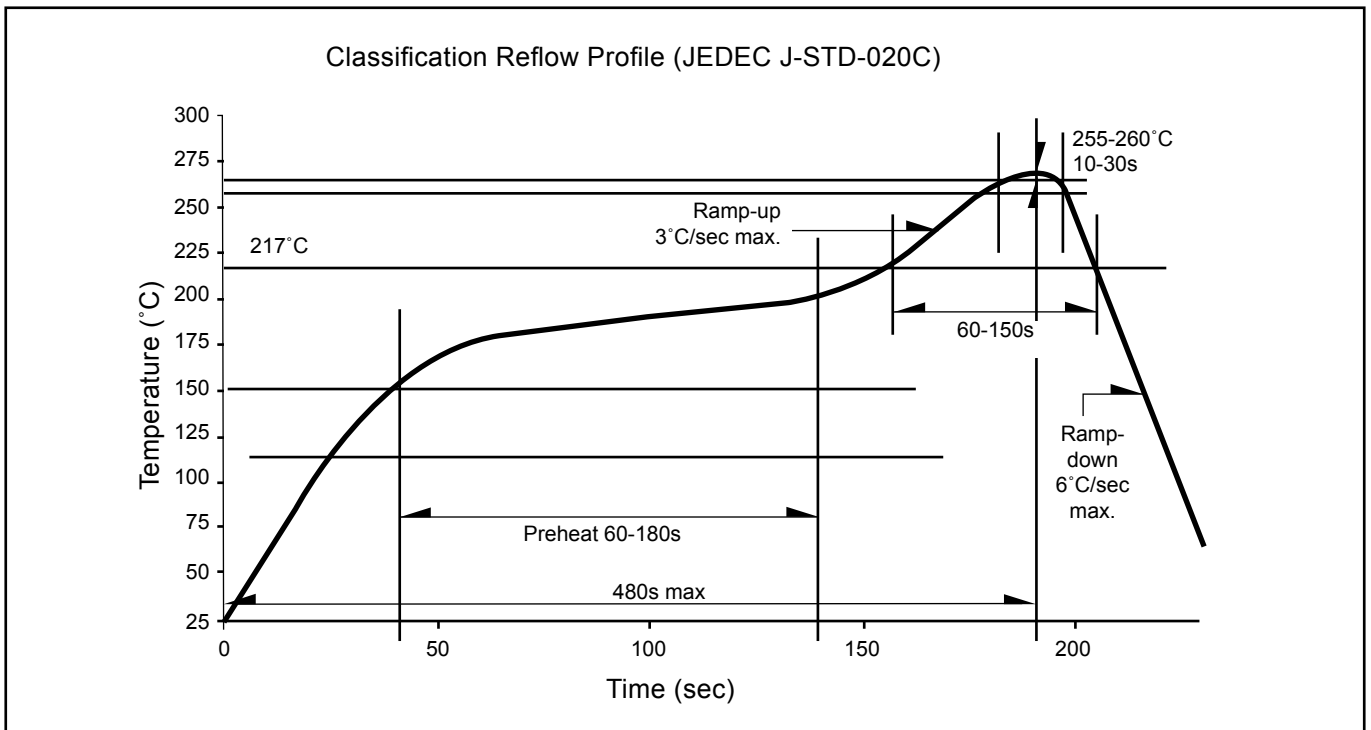

**Revision History**

Page	Subjects	Date of Modification
-	New Format	11 Aug 2006
-	Update company name	04 May 2010
-	Not for new design: DMRG-GJS-LM+LM-1, DMYG-GJS-LM+LM-1 Add new partno: DMRG-GJS-LM+MN-1, DMYG-GJS-LM+MN-1	21 Jul 2010

**NOTE**

All the information contained in this document is considered to be reliable at the time of publishing. However, DOMINANT Opto Technologies does not assume any liability arising out of the application or use of any product described herein.

DOMINANT Opto Technologies reserves the right to make changes at any time without prior notice to any products in order to improve reliability, function or design.

DOMINANT Opto Technologies products are not authorized for use as critical components in life support devices or systems without the express written approval from the Managing Director of DOMINANT Opto Technologies.

## About Us

DOMINANT Opto Technologies is a dynamic Malaysian Corporation that is among the world's leading SMT LED Manufacturers. An excellence – driven organization, it offers a comprehensive product range for diverse industries and applications. Featuring an internationally certified quality assurance acclaim, DOMINANT's extra bright LEDs are perfectly suited for various lighting applications in the automotive, consumer and communications as well as industrial sectors. With extensive industry experience and relentless pursuit of innovation, DOMINANT's state-of-art manufacturing, research and testing capabilities have become a trusted and reliable brand across the globe. More information about DOMINANT Opto Technologies can be found on the Internet at <http://www.dominant-semi.com>.

### **Please contact us for more information:**

#### Head Quarter

DOMINANT Opto Technologies Sdn. Bhd.  
Lot 6, Batu Berendam, FTZ Phase III, 75350 Melaka, Malaysia  
Tel: (606) 283 3566 Fax: (606) 283 0566  
E-mail: [sales@dominant-semi.com](mailto:sales@dominant-semi.com)

#### DOMINANT Semiconductors Malaysia Sdn. Bhd. Shanghai Representative Office

DOMINANT Semiconductors (Shenzhen) Co. Ltd.  
Rm 1007, DaZhong Building, No. 1515 Zhong Shan (W) Rd, Shanghai, China 200235  
Tel: +86 21 6428 6428 Fax: +86 21 6428 6880  
E-mail: [sales\\_china@dominant-semi.com](mailto:sales_china@dominant-semi.com)

#### DOMINANT Korea Sales Office

DOMINANT Semiconductors Korea Inc.  
RM 211 SUNTEAK CITY APT. 513-15 Sangdaewon-dong, Jungwon-gu, Seongnam-si, Gyeonggi-do, 462-725, Korea  
Tel: +82-31-701-5203 Fax: +82-31-701-5204  
E-mail: [sales\\_korea@dominant-semi.com](mailto:sales_korea@dominant-semi.com)

#### DOMINANT U.S.A Sales Office

25 Rockaway Road, 08833 Lebanon, New Jersey, USA  
Tel: (908) 439-9930 Cell: (908) 343-5810 Fax: (908) 439-9929  
E-mail: [don.wendel@dominant-semi.com](mailto:don.wendel@dominant-semi.com)

#### DOMINANT Europe Sales Office

DOMINANT Semiconductors Europe GmbH  
Raiffeisenstr. 38, 74906 Bad Rappenau Germany  
Tel: +49 (0) 7264-89010-10 / +49 (0) 7264-89010-11 Cell: +49 173-6907370 / +49 173-6907751  
Fax: +49 (0) 7264-89010-29  
E-mail: [gerd.wachno@dominant-semi.eu](mailto:gerd.wachno@dominant-semi.eu); [hartmut.wettengl@dominant-semi.eu](mailto:hartmut.wettengl@dominant-semi.eu)

#### DOMINANT India Sales Office

C-11,Vasanth Business Centre #86, TTK Road, Alwarpet Chennai - 600 018, INDIA  
Tel: 91-44-42030616 / 516 Cell: 91-9444920537 Fax: 91-9444920616  
E-mail: [pravat.behera@dominant-semi.com](mailto:pravat.behera@dominant-semi.com)

