

PQ1Lx3MSPQ Series

Compact Surface Mount Type
Low Power-Loss Voltage Regulators

■ Features

- 1.Compact surface mount package (4.5×4.3×1.5mm)
- 2.Output current : MAX.300mA
- 3.Power dissipation : MAX.900mW
(At mounting PCB shown in Fig.3)
- 4.Built-in ON/OFF control function
- 5.Built-in overcurrent, overheat protection functions
- 6.Use of ceramic capacitor is possible as output smooth capacitor
- 7.RoHS directive compliant

■ Applications

- 1.CD-ROM drives
- 2.DVD-ROM drives

■ Model Line-up

Output Voltage (TYP.)	Model No.
1.5V	PQ1LA153MSPQ
1.8V	PQ1LA183MSPQ
2.5V	PQ1LA253MSPQ
3.0V	PQ1LA303MSPQ
3.3V	PQ1LA333MSPQ
5.0V	PQ1LA503MSPQ
9.0V	PQ1LA903MSPQ

■ Absolute Maximum Ratings

(Ta=25°C)

Parameter	Symbol	Rating	Unit
*1 Input voltage	V _{IN}	15	V
*1 Output control voltage	V _C	15	V
Output current	I _O	300	mA
*2 Power dissipation	P _D	900	mW
*3 Junction temperature	T _J	150	°C
Operating temperature	T _{opr}	-40 to +85	°C
Storage temperature	T _{stg}	-55 to +150	°C
Soldering temperature	T _{sol}	270(10s)	°C

*1 All are open except GND and applicable terminals.
 *2 At surface-mounted condition
 *3 Overheat protection may operate at T_J:125°C to 150°C

■ Outline Dimensions

(Unit : mm)

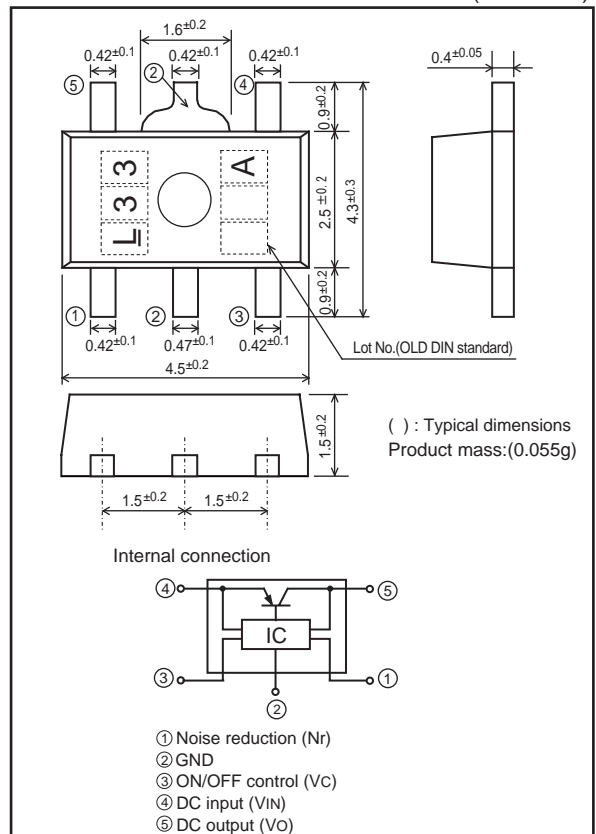

Lead finish:Lead-free solder plating
(Composition: Sn2Bi)

Notice The content of data sheet is subject to change without prior notice.

In the absence of confirmation by device specification sheets, SHARP takes no responsibility for any defects that may occur in equipment using any SHARP devices shown in catalogs, data books, etc. Contact SHARP in order to obtain the latest device specification sheets before using any SHARP device.

Electrical Characteristics

(Unless otherwise specified condition shall be $V_{IN}=V_o(\text{TYP.})+1.0\text{V}$, $I_o=30\text{mA}$, $V_c=1.8\text{V}$, $T_a=25^\circ\text{C}$)

Parameter	Symbol	Conditions	MIN.	TYP.	MAX.	Unit
Output voltage	V_o	—	Refer to list.1			V
Input voltage	V_{IN}	—	2.5	—	15	V
Load regulation	R_{regL}	$V_o < 3\text{V}$, $I_o = 5$ to 300mA	—	10	60	mV
		$V_o \geq 3\text{V}$, $I_o = 5$ to 300mA	—	0.2	2	%
Line regulation	R_{regL}	$V_o < 3\text{V}$, $V_{IN} = V_o(\text{TYP.}) + 1\text{V}$ to $V_o(\text{TYP.}) + 6\text{V}$	—	5	15	mV
		$V_o \geq 3\text{V}$, $V_{IN} = V_o(\text{TYP.}) + 1\text{V}$ to $V_o(\text{TYP.}) + 6\text{V}$	—	0.05	0.5	%
Temperature coefficient of output voltage	$T_C V_o$	$I_o = 10\text{mA}$, $T_j = 0$ to 100°C	—	± 0.5	—	%
⁴ Ripple rejection	RR	Refer to Fig.2	—	55	—	dB
⁴ Output noise voltage	$V_{\text{no(rms)}}$	$10\text{Hz} < f < 100\text{kHz}$, $C_n = 0.1\mu\text{F}$, $I_o = 30\text{mA}$	—	50	—	μV
Dropout voltage	V_{I-O}	$I_o = 300\text{mA}$, ^{5,6}	—	0.4	0.7	V
⁷ On-state voltage for control	$V_{C(\text{ON})}$	—	1.8	—	—	V
On-state current for control	$I_{C(\text{ON})}$	$V_c = 1.8\text{V}$	—	5	30	μA
Off-voltage for control	$V_{C(\text{OFF})}$	—	—	—	0.4	V
Quiescent current	I_q	$I_o = 0\text{mA}$	—	550	800	μA
Output off-state consumption current	I_{qs}	$V_c = 0.2\text{V}$	—	—	1	μA

⁴ Typical value of 3.3V output model.

⁵ Input voltage when output voltage falls 0.1V from that at $V_{IN}=V_o(\text{TYP.})+1.0\text{V}$.

⁶ $V_{IN(\text{MIN})}=2.5\text{V}$ (PQ1LA153MSPQ, PQ1LA183MSPQ)

⁷ In case that the control terminal (③ pin) is non-connection, output voltage should be OFF state.

List.1 Output voltage Line-up

Parameter	Symbol	Conditions	MIN.	TYP.	MAX.	Unit
PQ1LA153MSPQ	V_o	$V_{IN}=V_o(\text{TYP.})+1.0\text{V}$, $I_o=30\text{mA}$, $V_c=1.8\text{V}$, $T_a=25^\circ\text{C}$	1.440	1.5	1.560	V
PQ1LA183MSPQ			1.740	1.8	1.860	
PQ1LA253MSPQ			2.440	2.5	2.560	
PQ1LA303MSPQ			2.940	3.0	3.060	
PQ1LA333MSPQ			3.234	3.3	3.366	
PQ1LA503MSPQ			4.900	5.0	5.100	
PQ1LA903MSPQ			8.820	9.0	9.180	

Fig.1 Standard measuring circuit of Regulator portion

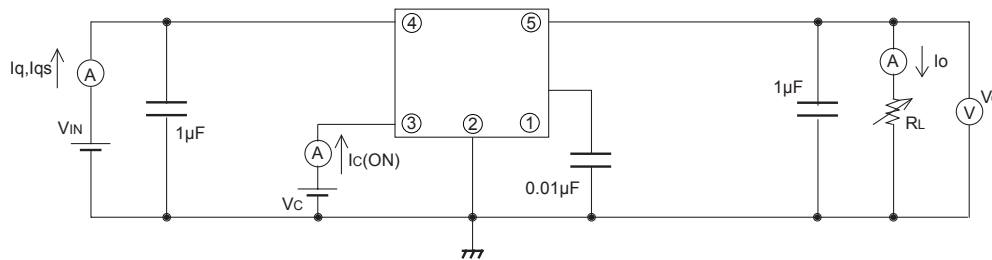

Fig.2 Standard measuring circuit of critical rate of ripple rejection

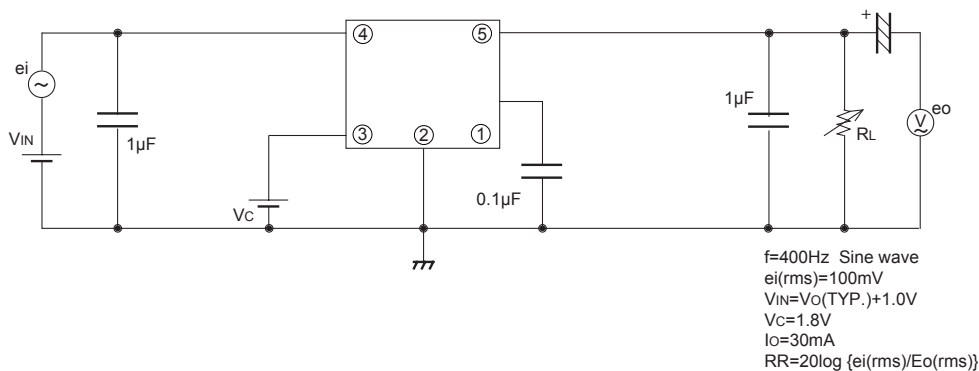
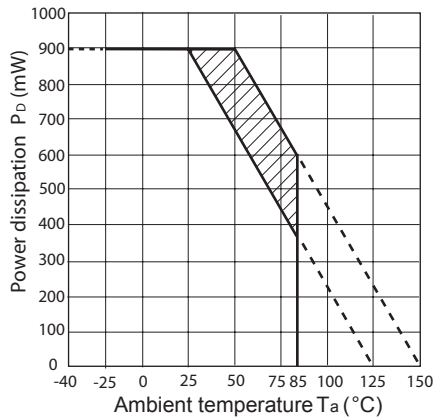
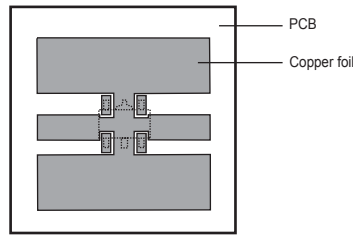

Fig.3 Power Dissipation vs. Ambient Temperature



Mounting PCB



Material : Glass-cloth epoxy resin
 PCB Size : 20mm × 20mm × 1.0mm
 Copper foil area : 180mm²
 Thickness of copper : 35μm

Note) Oblique line portion: Overheat protection may operate in this area.

Fig.4 Overcurrent Protection Characteristics

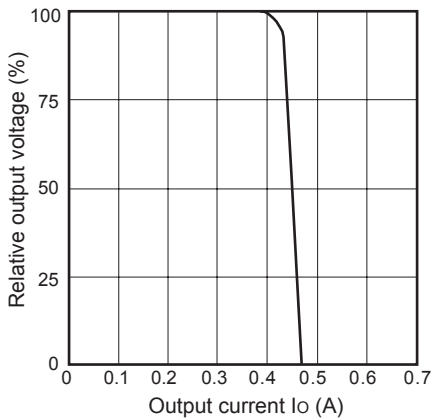

Fig.5 Output Voltage vs. Input Voltage (Typical Value) (PQ1LA333MSPQ)

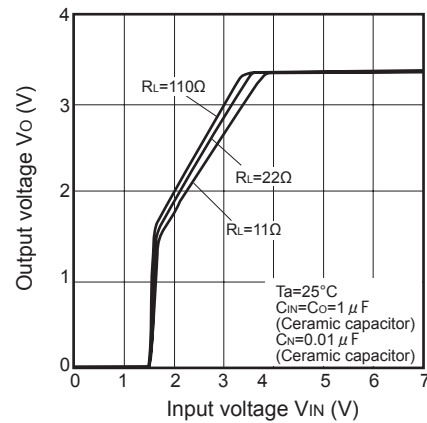

Fig.6 Circuit Operating Current vs. Input Voltage (Typical Value) (PQ1LA333MSPQ)

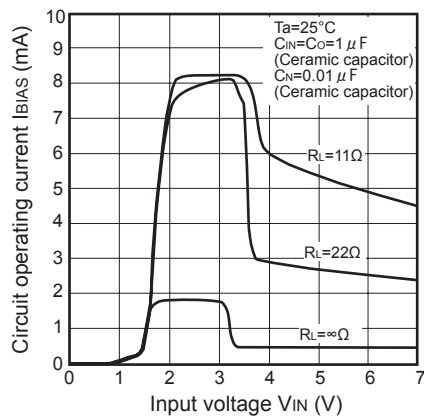

Fig.7 Quiescent Current vs. Junction Temperature (Typical Value)

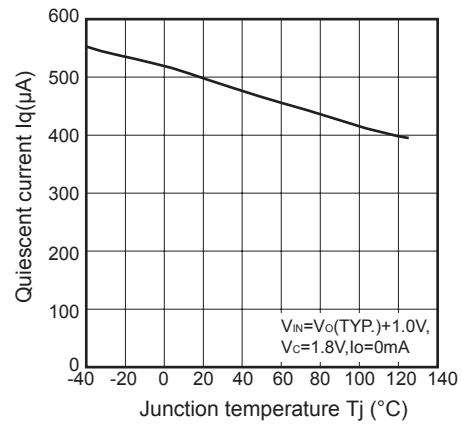

Fig.8 Dropout Voltage vs. Junction Temperature (Typical Value) (PQ1LA333MSPQ)

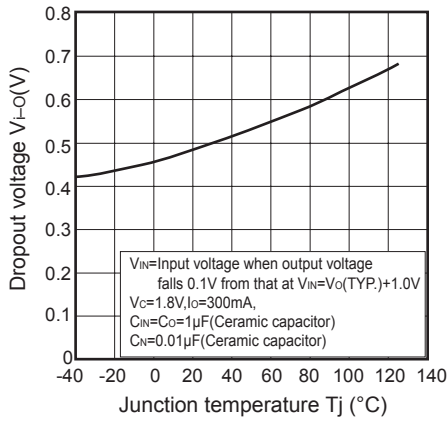

Fig.9 Output Voltage Deviation vs. Junction Temperature (Typical Value) (PQ1LA333MSPQ)

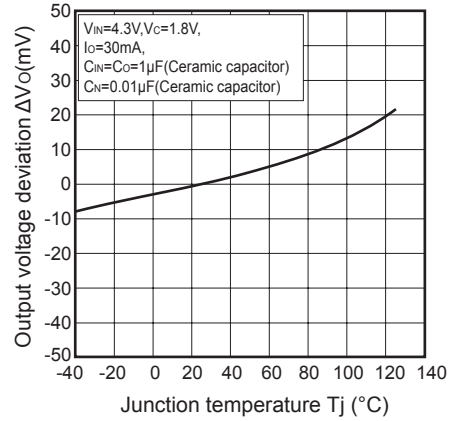

Fig.10 Dropout Voltage vs. Output Current (Typical Value)

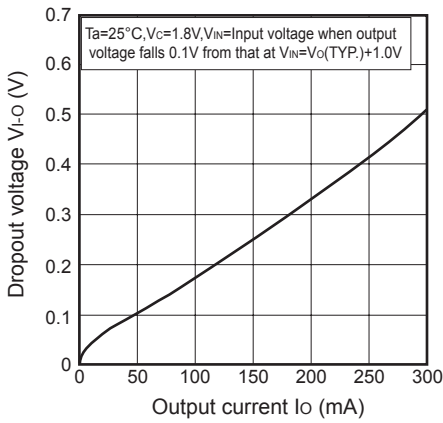

Fig.11 Ripple Rejection vs. Input Ripple Frequency (Typical Value) (PQ1LA333MSPQ)

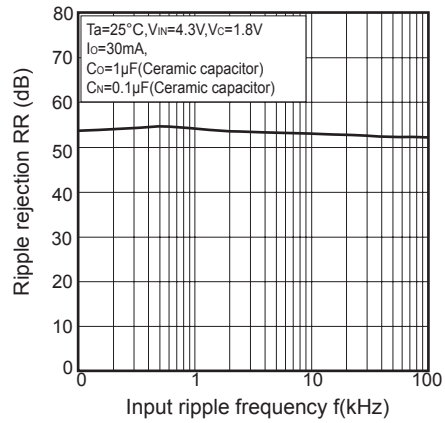
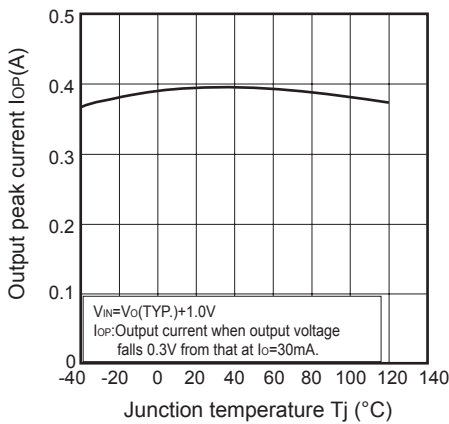

Fig.12 Output Peak Current vs. Junction Temperature (Typical Value)



■ Example of application

