

# PQxxxRDA2SZH Series

TO-220 Type, 2A Output Low Power-Loss Voltage Regulators

## ■ Features

1. Low power-loss  
Dropout voltage: MAX. 1.0V (I<sub>o</sub>=2.0A)
2. Output current: 2A
3. Low dissipation current  
(Dissipation current at no load: MAX. 8mA  
Output OFF-state dissipation current: MAX. 5μA)
4. Built-in ON/OFF function
5. Built-in overcurrent and overheat protection functions
6. Built-in ASO protect function
7. RoHS directive compliant

## ■ Applications

1. Power supplies for various electronic equipment such as AV, OA

## ■ Model Line-up

| Output voltage | Model No.           | Output voltage | Model No.           |
|----------------|---------------------|----------------|---------------------|
| 3.3V           | <b>PQ033RDA2SZH</b> | 9.0V           | <b>PQ090RDA2SZH</b> |
| 5.0V           | <b>PQ050RDA2SZH</b> | 12.0V          | <b>PQ120RDA2SZH</b> |

## ■ Absolute Maximum Ratings

(Ta=25°C)

| Parameter                          | Symbol           | Rating      | Unit |
|------------------------------------|------------------|-------------|------|
| *1 Input voltage                   | V <sub>IN</sub>  | 20          | V    |
| *1 ON/OFF control terminal voltage | V <sub>C</sub>   | 20          | V    |
| Output current                     | I <sub>o</sub>   | 2.0         | A    |
|                                    |                  |             |      |
| *2 Power dissipation               | P <sub>D1</sub>  | 1.4         | W    |
|                                    | P <sub>D2</sub>  | 15          |      |
| *3 Junction temperature            | T <sub>j</sub>   | 150         | °C   |
| Operating temperature              | T <sub>opr</sub> | -40 to +85  | °C   |
| Storage temperature                | T <sub>stg</sub> | -40 to +150 | °C   |
| Soldering temperature              | T <sub>sol</sub> | 260(10s)    | °C   |

\*1 All are open except GND and applicable terminals.  
 \*2 P<sub>D1</sub>: No heat sink, P<sub>D2</sub>: With infinite heat sink.  
 \*3 Overheat protection may operate at T<sub>j</sub>=125°C to 150°C

## ■ Outline Dimensions

(Unit : mm)

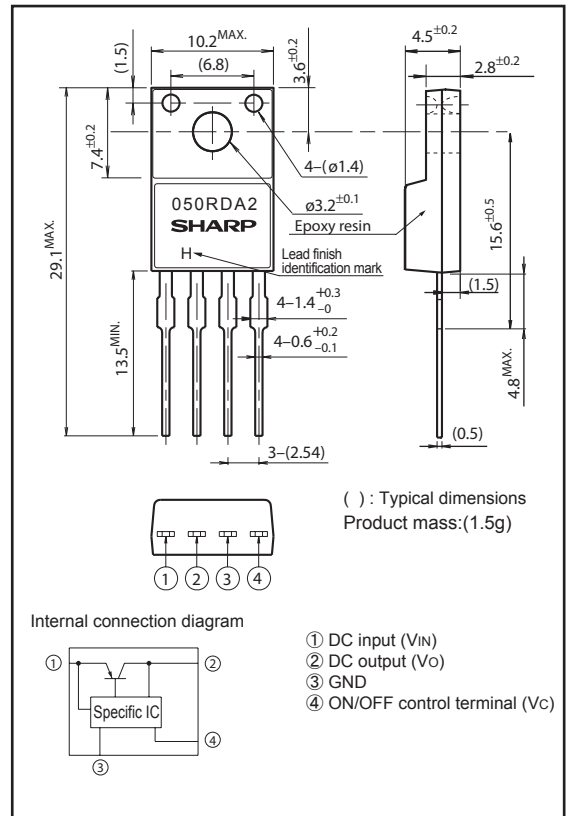

Lead finish: Lead-free solder plating  
 (Composition: Sn2Cu)

Notice The content of data sheet is subject to change without prior notice.

In the absence of confirmation by device specification sheets, SHARP takes no responsibility for any defects that may occur in equipment using any SHARP devices shown in catalogs, data books, etc. Contact SHARP in order to obtain the latest device specification sheets before using any SHARP device.

### Electrical Characteristics

(Unless otherwise specified, condition shall be  $V_{IN}=V_O(TYP.)+2V, I_O=1.0A, V_C=2.7V, T_a=25^\circ C$ )

| Parameter                                 | Symbol       | Conditions                                       | MIN.                     | TYP.       | MAX. | Unit          |
|---|--------------|--|--------------------------|------------|------|---------------|
| Output voltage                            | $V_O$        | -  | Refer to the table below |            |      | V             |
| Load regulation                           | $Reg_L$      | $I_O=5mA$ to 2A                                  | -                        | 0.1        | 1.0  | %             |
| Line regulation                           | $Reg_L$      | $V_{IN}=V_O(TYP.)+1V$ to $V_O(TYP.)+7V, I_O=5mA$ | -                        | 0.1        | 1.0  | %             |
| Temperature coefficient of output voltage | $T_C V_O$    | $T_j=0$ to $+125^\circ C, I_O=5mA$               | -                        | $\pm 0.01$ | -    | %/ $^\circ C$ |
| Ripple rejection                          | RR           | -  | -                        | 60         | -    | dB            |
| Dropout voltage                           | $V_{I-O}$    | $I_O=2.0A$                                       | -                        | -          | 1.0  | V             |
| *5 ON-state voltage for control           | $V_{C(ON)}$  | -  | 2.0                      | -          | -    | V             |
| ON-state current for control              | $I_{C(ON)}$  | $V_C=2.7V$                                       | -                        | -          | 200  | $\mu A$       |
| OFF-state voltage for control             | $V_{C(OFF)}$ | -  | -                        | -          | 0.8  | V             |
| OFF-state current for control             | $I_{C(OFF)}$ | $V_C=0.4V$                                       | -                        | -          | 2    | $\mu A$       |
| Quiescent current                         | $I_q$        | $I_O=0A$   | -                        | -          | 8    | mA            |
| Output OFF-state dissipation current      | $I_{qs}$     | $I_O=0A, V_C=0.4V$                               | -                        | -          | 5    | $\mu A$       |

\*4  $V_{IN}=3.8V$ (PQ033RDA2SZH), Input voltage shall be the value when output voltage is 95% in comparison with the initial value(PQ050RDA2SZH,PQ090RDA2SZH,PQ120RDA2SZH).

\*5 In case of opening control terminal ④, output voltage turns off.

Table.1 Output Voltage Line-up

| Model No.    | Symbol | Conditions  | MIN.  | TYP. | MAX.  | Unit |
|--------------|--------|---|-------|------|-------|------|
| PQ033RDA2SZH | $V_O$  | $V_{IN}=V_O(TYP.)+2V, I_O=1.0A, V_C=2.7V, T_a=25^\circ C$ | 3.218 | 3.3  | 3.382 | V    |
| PQ050RDA2SZH |        |   | 4.875 | 5.0  | 5.125 |      |
| PQ090RDA2SZH |        |   | 8.775 | 9.0  | 9.225 |      |
| PQ120RDA2SZH |        |   | 11.70 | 12.0 | 12.30 |      |

Fig.1 Test Circuit

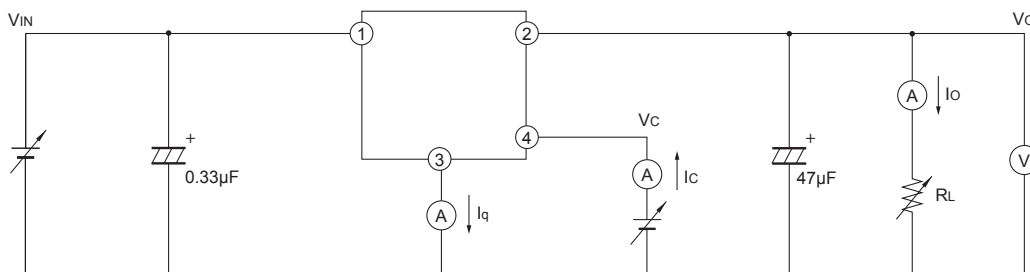

Fig.2 Test Circuit of Ripple Rejection

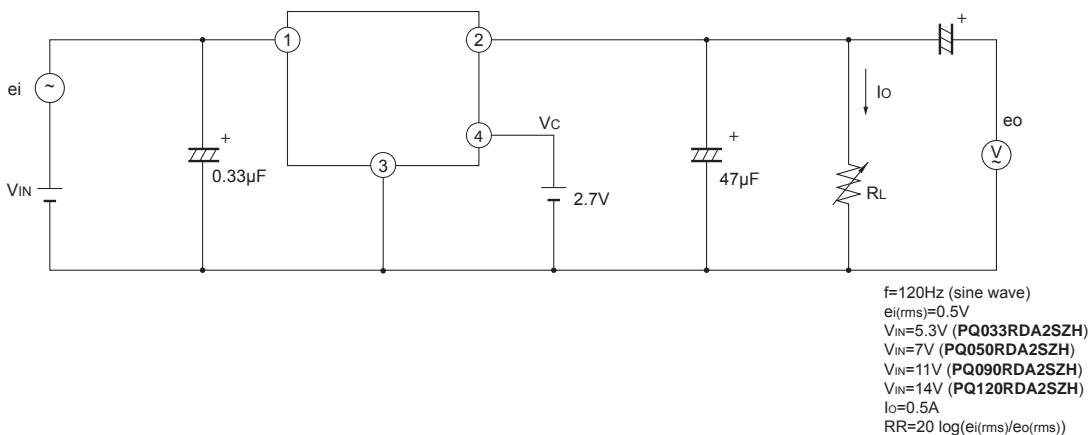
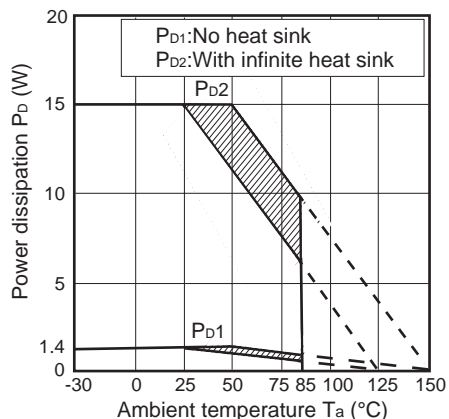

Fig.3 Power Dissipation vs. Ambient Temperature



Note) Oblique line portion: Overheat protection may operate in this area.

Fig.4 Overcurrent Protection Characteristics (PQ033RDA2SZH)

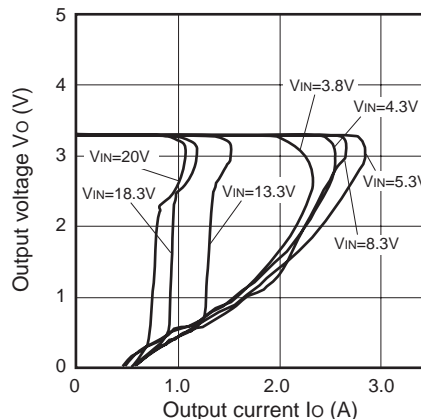

Fig.5 Overcurrent Protection Characteristics (PQ050RDA2SZH)

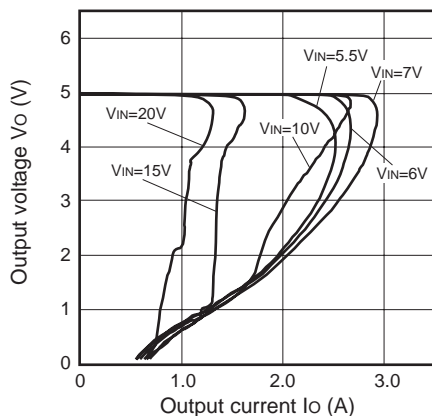

Fig.6 Overcurrent Protection Characteristics (PQ090RDA2SZH)

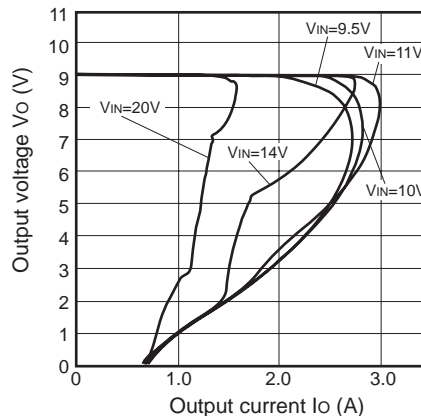

Fig.7 Overcurrent Protection Characteristics (PQ120RDA2SZH)

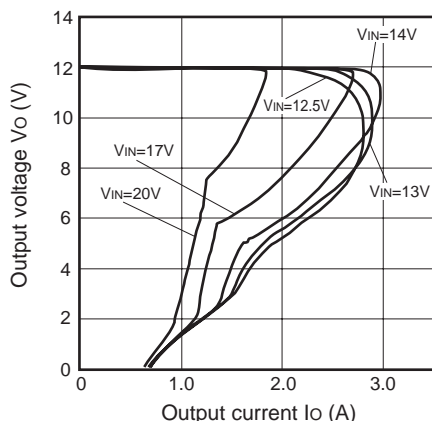

Fig.8 Output Voltage vs. Input Voltage (PQ033RDA2SZH)

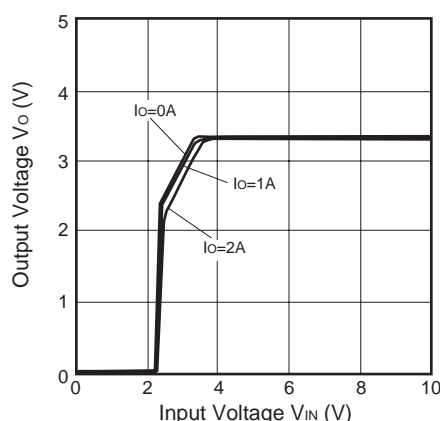

Fig.9 Output Voltage vs. Input Voltage (PQ050RDA2SZH)

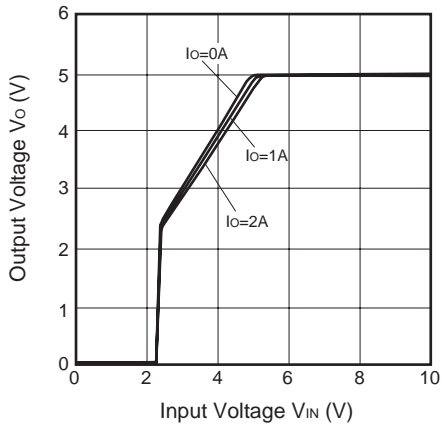

Fig.10 Output Voltage vs. Input Voltage (PQ090RDA2SZH)

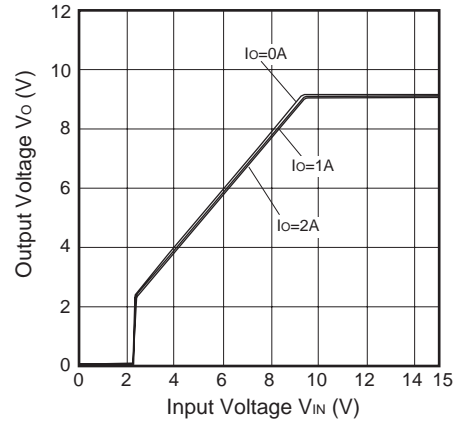

Fig.11 Output Voltage vs. Input Voltage (PQ120RDA2SZH)

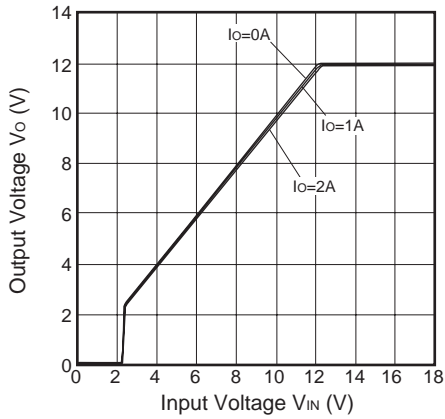

Fig.12 Circuit Operating Current vs. Input Voltage (PQ033RDA2SZH)

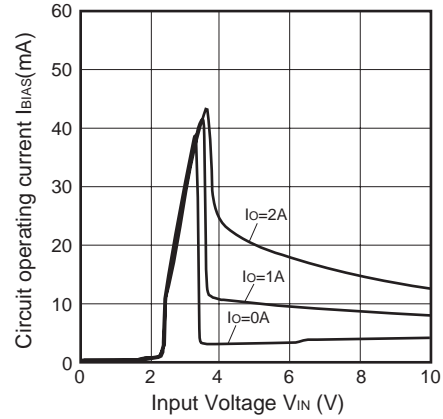

Fig.13 Circuit Operating Current vs. Input Voltage (PQ050RDA2SZH)

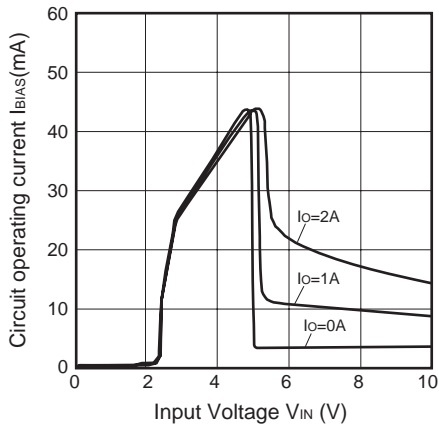

Fig.14 Circuit Operating Current vs. Input Voltage (PQ090RDA2SZH)

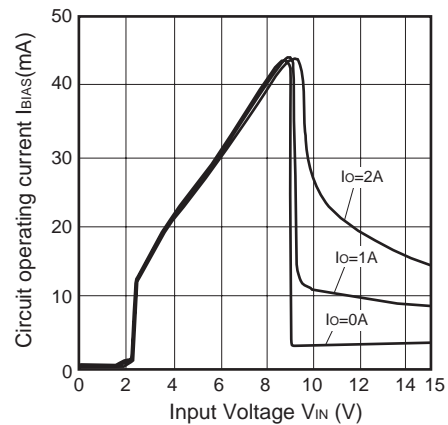

Fig.15 Circuit Operating Current vs. Input Voltage (PQ120RDA2SZH)

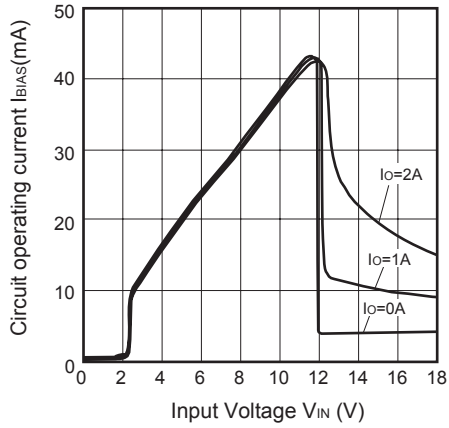

Fig.16 Dropout Voltage vs. Output Current (PQxxxRDA2SZH)

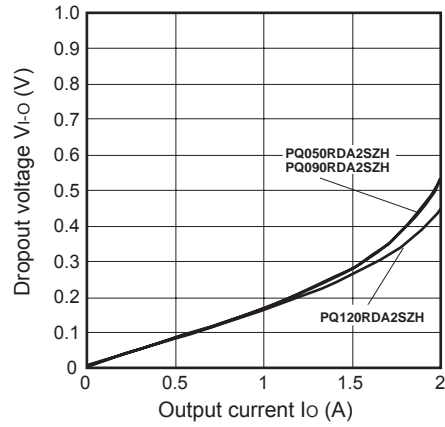

Fig.17 Output Voltage Fluctuation vs. Junction Temperature (PQ033RDA2SZH)

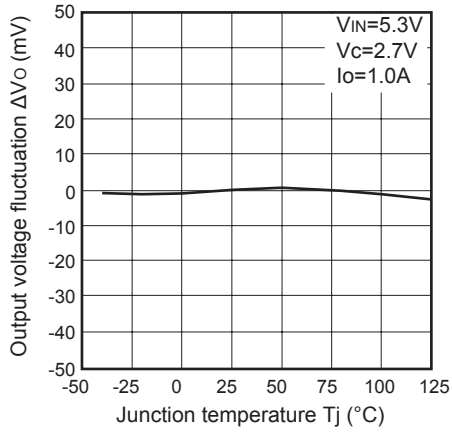

Fig.18 Output Voltage Fluctuation vs. Junction Temperature (PQ050RDA2SZH)

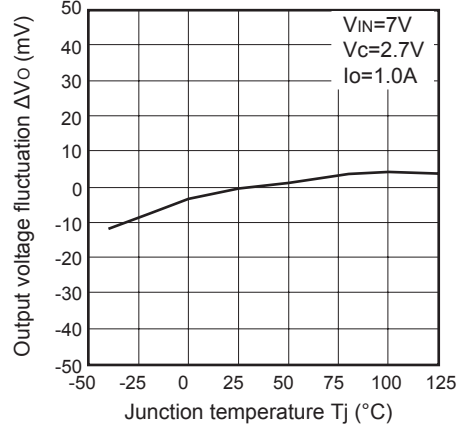

Fig.19 Output Voltage Fluctuation vs. Junction Temperature (PQ090RDA2SZH)

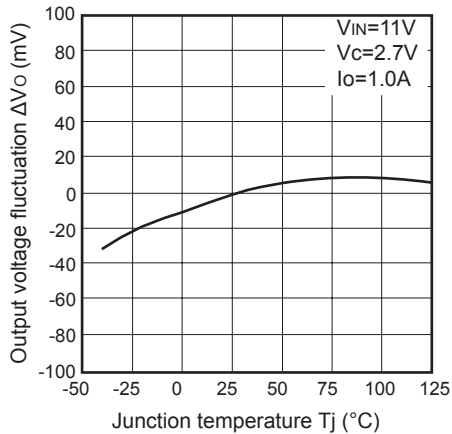

Fig.20 Output Voltage Fluctuation vs. Junction Temperature (PQ120RDA2SZH)

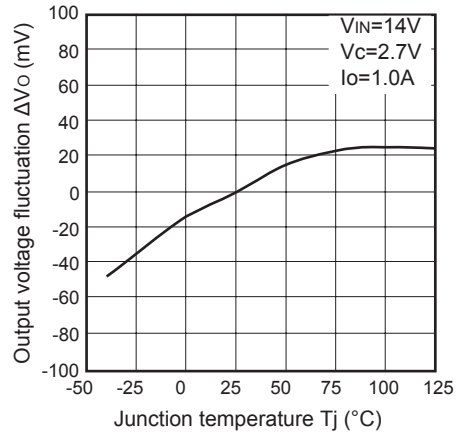

Fig.21 Dropout Voltage vs. Junction Temperature (PQxxxRDA2SZH)

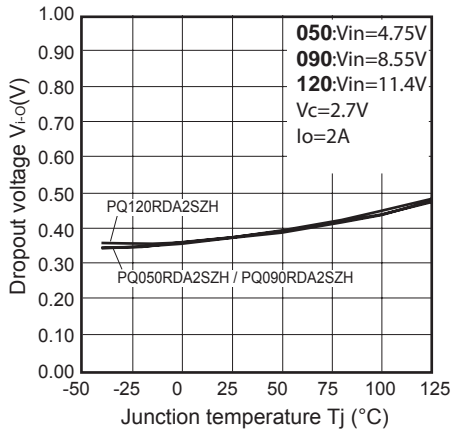

Fig.22 Quiescent Current vs. Junction Temperature (PQxxxRDA2SZH)

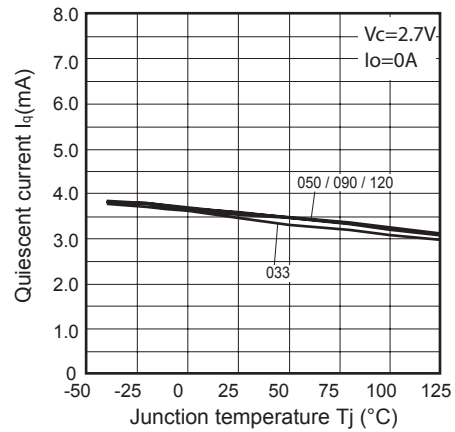

Fig.23 ON/OFF Threshold Voltage vs. Junction Temperature (PQ090RDA2SZH)

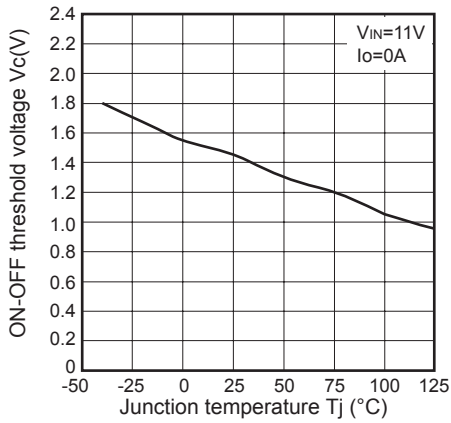

Fig.24 Ripple Rejection vs. Input Ripple Frequency (PQxxxRDA2SZH)

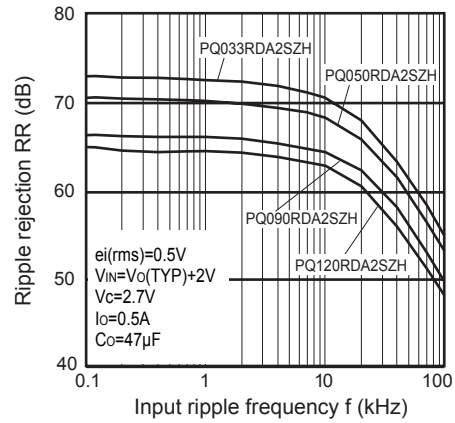
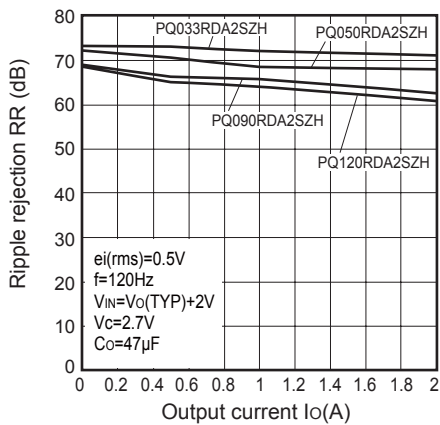

Fig.25 Ripple Rejection vs. Output Current (PQxxxRDA2SZH)



### ■ Typical Application

