

## HIGH RIPPLE-REJECTION LOW DROPOUT HIGH OUTPUT CURRENT CMOS VOLTAGE REGULATOR

## S-1170 Series

The S-1170 Series is a positive voltage regulator with a low dropout voltage, high output voltage accuracy, and low current consumption developed based on CMOS technology.

A built-in low on-resistance transistor provides a low dropout voltage and large output current, a built-in overcurrent protector prevents the load current from exceeding the current capacitance of the output transistor, and a built-in thermal shutdown circuit prevents damage caused by the heat. An ON/OFF circuit ensures a long battery life. Compared with the voltage regulators using the conventional CMOS process, a larger variety of capacitors are available, including small ceramic capacitors. Small SOT-89-5 and 6-Pin HSON(A) packages realize high-density mounting.

### ■ Features

- Output voltage: 1.5 V to 5.5 V, selectable in 0.1 V steps.
- High-accuracy output voltage:  $\pm 1.0\%$
- Low dropout voltage: 120 mV typ. (3.0 V output product,  $I_{OUT} = 300$  mA)
- Low current consumption: During operation: 80  $\mu$ A typ., 160  $\mu$ A max.  
During shutdown: 0.1  $\mu$ A typ., 1.0  $\mu$ A max.
- High peak current capability: 800 mA output is possible (at  $V_{IN} \geq V_{OUT(S)} + 1.0$  V)<sup>\*1</sup>
- Built-in ON/OFF circuit: Ensures long battery life.
- Low ESR capacitor can be used: A ceramic capacitor of 4.7  $\mu$ F or more can be used for the output capacitor.
- High ripple rejection: 70 dB typ. (at 1.0 kHz)
- Built-in overcurrent protector: Overcurrent of output transistor can be restricted.
- Built-in thermal shutdown circuit: Damage caused by heat can be prevented.
- Small package: SOT-89-5, 6-Pin HSON(A)

\*1. Attention should be paid to the power dissipation of the package when the output current is large.

### ■ Applications

- Power supply for DVD and CD-ROM drives
- Power supply for battery-powered devices
- Power supply for personal communication devices
- Power supply for note PCs

### ■ Packages

Package Name	Drawing Code		
	Package	Tape	Reel
SOT-89-5	UP005-A	UP005-A	UP005-A
6-Pin HSON(A)	PD006-A	PD006-A	PD006-A

■ Block Diagram

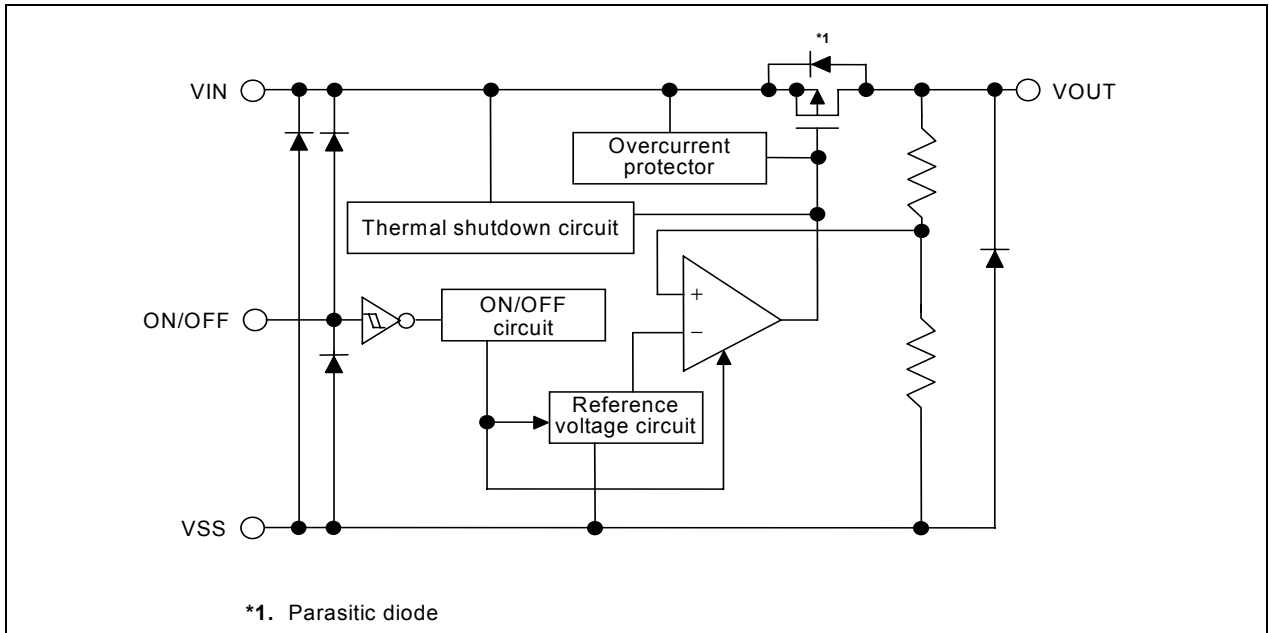
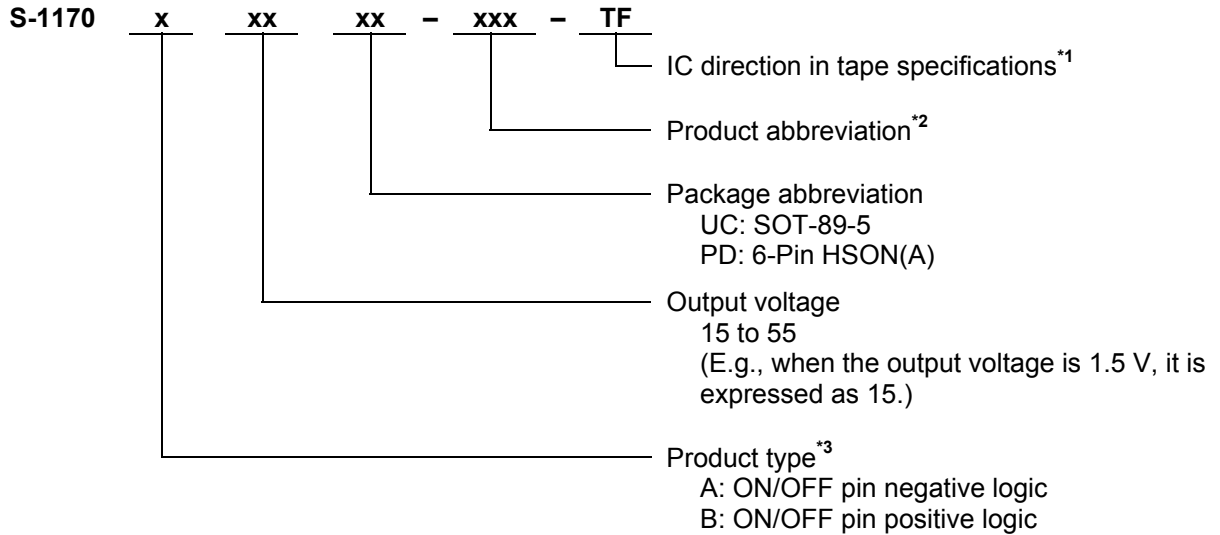


Figure 1

■ **Product Name Structure**

- The product types, output voltage, and package types for the S-1170 Series can be selected at the user's request. Refer to the "Product name" for the meanings of the characters in the product name and "Product name list" for the full product names.

1. Product name



\*1. Refer to the taping specifications at the end of this book.  
 \*2. Refer to the product name list.  
 \*3. Refer to 3. Shutdown pin (ON/OFF pin) under the Operation.

2. Product name list

**Table 1**

Output Voltage	SOT-89-5	6-Pin HSON(A)
1.5 V $\pm$ 1.0%	S-1170B15UC-OTA-TF	S-1170B15PD-OTA-TF
1.6 V $\pm$ 1.0%	S-1170B16UC-OTB-TF	S-1170B16PD-OTB-TF
1.7 V $\pm$ 1.0%	S-1170B17UC-OTC-TF	S-1170B17PD-OTC-TF
1.8 V $\pm$ 1.0%	S-1170B18UC-OTD-TF	S-1170B18PD-OTD-TF
1.9 V $\pm$ 1.0%	S-1170B19UC-OTE-TF	S-1170B19PD-OTE-TF
2.0 V $\pm$ 1.0%	S-1170B20UC-OTF-TF	S-1170B20PD-OTF-TF
2.1 V $\pm$ 1.0%	S-1170B21UC-OTG-TF	S-1170B21PD-OTG-TF
2.2 V $\pm$ 1.0%	S-1170B22UC-OTH-TF	S-1170B22PD-OTH-TF
2.3 V $\pm$ 1.0%	S-1170B23UC-OTI-TF	S-1170B23PD-OTI-TF
2.4 V $\pm$ 1.0%	S-1170B24UC-OTJ-TF	S-1170B24PD-OTJ-TF
2.5 V $\pm$ 1.0%	S-1170B25UC-OTK-TF	S-1170B25PD-OTK-TF
2.6 V $\pm$ 1.0%	S-1170B26UC-OTL-TF	S-1170B26PD-OTL-TF
2.7 V $\pm$ 1.0%	S-1170B27UC-OTM-TF	S-1170B27PD-OTM-TF
2.8 V $\pm$ 1.0%	S-1170B28UC-OTN-TF	S-1170B28PD-OTN-TF
2.9 V $\pm$ 1.0%	S-1170B29UC-OTO-TF	S-1170B29PD-OTO-TF
3.0 V $\pm$ 1.0%	S-1170B30UC-OTP-TF	S-1170B30PD-OTP-TF
3.1 V $\pm$ 1.0%	S-1170B31UC-OTQ-TF	S-1170B31PD-OTQ-TF
3.2 V $\pm$ 1.0%	S-1170B32UC-OTR-TF	S-1170B32PD-OTR-TF
3.3 V $\pm$ 1.0%	S-1170B33UC-OTS-TF	S-1170B33PD-OTS-TF
3.4 V $\pm$ 1.0%	S-1170B34UC-OTT-TF	S-1170B34PD-OTT-TF
3.5 V $\pm$ 1.0%	S-1170B35UC-OTU-TF	S-1170B35PD-OTU-TF
3.6 V $\pm$ 1.0%	S-1170B36UC-OTV-TF	S-1170B36PD-OTV-TF
3.7 V $\pm$ 1.0%	S-1170B37UC-OTW-TF	S-1170B37PD-OTW-TF
3.8 V $\pm$ 1.0%	S-1170B38UC-OTX-TF	S-1170B38PD-OTX-TF
3.9 V $\pm$ 1.0%	S-1170B39UC-OTY-TF	S-1170B39PD-OTY-TF
4.0 V $\pm$ 1.0%	S-1170B40UC-OTZ-TF	S-1170B40PD-OTZ-TF
4.1 V $\pm$ 1.0%	S-1170B41UC-OUA-TF	S-1170B41PD-OUA-TF
4.2 V $\pm$ 1.0%	S-1170B42UC-OUB-TF	S-1170B42PD-OUB-TF
4.3 V $\pm$ 1.0%	S-1170B43UC-OUC-TF	S-1170B43PD-OUC-TF
4.4 V $\pm$ 1.0%	S-1170B44UC-OUA-TF	S-1170B44PD-OUA-TF
4.5 V $\pm$ 1.0%	S-1170B45UC-OUE-TF	S-1170B45PD-OUE-TF
4.6 V $\pm$ 1.0%	S-1170B46UC-OUF-TF	S-1170B46PD-OUF-TF
4.7 V $\pm$ 1.0%	S-1170B47UC-OUG-TF	S-1170B47PD-OUG-TF
4.8 V $\pm$ 1.0%	S-1170B48UC-OUH-TF	S-1170B48PD-OUH-TF
4.9 V $\pm$ 1.0%	S-1170B49UC-OUI-TF	S-1170B49PD-OUI-TF
5.0 V $\pm$ 1.0%	S-1170B50UC-OUI-TF	S-1170B50PD-OUI-TF
5.1 V $\pm$ 1.0%	S-1170B51UC-OUI-TF	S-1170B51PD-OUI-TF
5.2 V $\pm$ 1.0%	S-1170B52UC-OUI-TF	S-1170B52PD-OUI-TF
5.3 V $\pm$ 1.0%	S-1170B53UC-OUI-TF	S-1170B53PD-OUI-TF
5.4 V $\pm$ 1.0%	S-1170B54UC-OUI-TF	S-1170B54PD-OUI-TF
5.5 V $\pm$ 1.0%	S-1170B55UC-OUI-TF	S-1170B55PD-OUI-TF

**Remark** Please contact the SII marketing department for products with an output voltage other than those specified above or type A products.

■ Pin Configuration

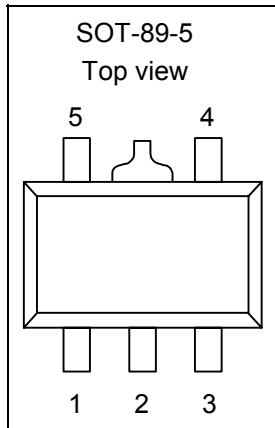


Figure 2

Table 2

Pin No.	Symbol	Description
1	ON/OFF	Shutdown pin
2	VSS	GND pin
3	NC*1	No connection
4	VIN	Input voltage pin
5	VOUT	Output voltage pin

\*1. The NC pin is electrically open.  
 The NC pin can be connected to VIN and VSS.

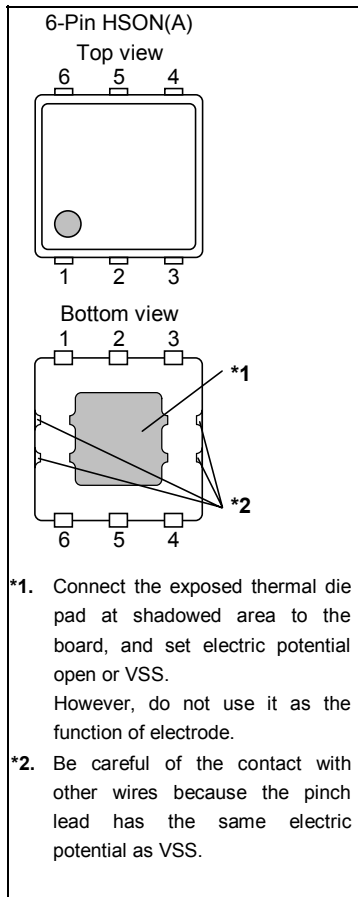


Figure 3

Table 3

Pin No.	Symbol	Description
1	VOUT*1	Output voltage pin
2	VOUT*1	Output voltage pin
3	ON/OFF	Shutdown pin
4	VSS	GND pin
5	VIN*2	Input voltage pin
6	VIN*2	Input voltage pin

\*1. Short pins 1 and 2.  
 \*2. Short pins 5 and 6.

■ **Absolute Maximum Ratings**

**Table 4**

(Ta = 25°C unless otherwise specified)

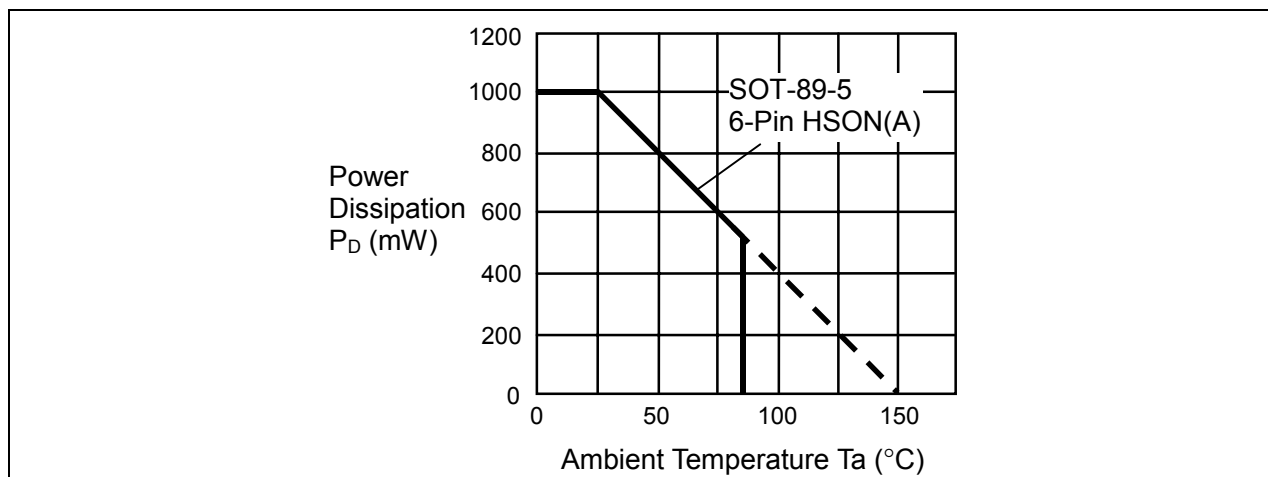
Parameter	Symbol	Absolute Maximum Rating		Unit
Input voltage	V <sub>IN</sub>	V <sub>SS</sub> - 0.3 to V <sub>SS</sub> + 7		V
	V <sub>ON/OFF</sub>	V <sub>SS</sub> - 0.3 to V <sub>IN</sub> + 0.3		
Output voltage	V <sub>OUT</sub>	V <sub>SS</sub> - 0.3 to V <sub>IN</sub> + 0.3		
Power dissipation	P <sub>D</sub>	SOT-89-5	1000 <sup>*1</sup>	mW
		6-Pin HSON(A)	1000 <sup>*1</sup>	
Operating ambient temperature	T <sub>opr</sub>	-40 to +85		°C
Storage ambient temperature	T <sub>stg</sub>	-40 to +125		

\*1. At mounted on printed circuit board

**[Mounted board]**

- (1) Board size : 40 mm × 40 mm × 1.6t mm
- (2) Cu wiring shear : 180 % at both sides

**Caution** The absolute maximum ratings are rated values exceeding which the product could suffer physical damage. These values must therefore not be exceeded under any conditions.



**Figure 4 Power Dissipation of Package (Mounted on Printed Circuit Board)**

**Caution** Thermal shutdown circuit may operate when junction temperature is 150 °C.

■ Electrical Characteristics

Table 5

(Ta = 25°C unless otherwise specified)

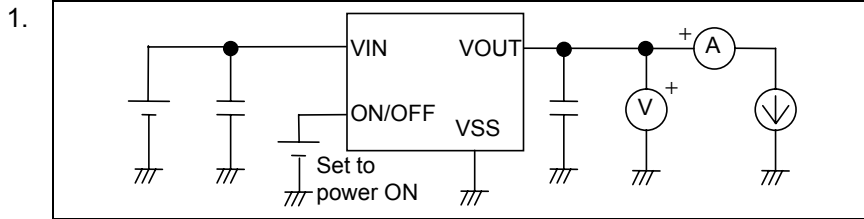
Parameter	Symbol	Conditions	Min.	Typ.	Max.	Unit	Test Circuit	
Output voltage*1	$V_{OUT(E)}$	$V_{IN} = V_{OUT(S)} + 1.0 \text{ V}$ , $I_{OUT} = 100 \text{ mA}$	$V_{OUT(S)} \times 0.99$	$V_{OUT(S)}$	$V_{OUT(S)} \times 1.01$	V	1	
Output current*2	$I_{OUT}$	$V_{IN} \geq V_{OUT(S)} + 1.0 \text{ V}$	800*5	—	—	mA	3	
Dropout voltage*3	$V_{drop}$	$I_{OUT} = 300 \text{ mA}$	$V_{OUT(S)} = 1.5 \text{ V}$	—	0.35	0.45	V	1
			$V_{OUT(S)} = 1.6 \text{ V}$	—	0.30	0.35		
			$V_{OUT(S)} = 1.7 \text{ V}$	—	0.25	0.30		
			$1.8 \text{ V} \leq V_{OUT(S)} \leq 2.0 \text{ V}$	—	0.20	0.26		
			$2.1 \text{ V} \leq V_{OUT(S)} \leq 2.9 \text{ V}$	—	0.15	0.22		
		$3.0 \text{ V} \leq V_{OUT(S)} \leq 5.5 \text{ V}$	—	0.12	0.18			
Line regulation	$\frac{\Delta V_{OUT1}}{\Delta V_{IN} \cdot V_{OUT}}$	$V_{OUT(S)} + 0.5 \text{ V} \leq V_{IN} \leq 6.5 \text{ V}$ , $I_{OUT} = 100 \text{ mA}$	—	0.05	0.3	% / V		
Load regulation	$\Delta V_{OUT2}$	$V_{IN} = V_{OUT(S)} + 1.0 \text{ V}$ , $1.0 \text{ mA} \leq I_{OUT} \leq 300 \text{ mA}$	—	30	100	mV		
Output voltage temperature coefficient*4	$\frac{\Delta V_{OUT}}{\Delta T_a \cdot V_{OUT}}$	$V_{IN} = V_{OUT(S)} + 1.0 \text{ V}$ , $I_{OUT} = 10 \text{ mA}$ , $-40^\circ\text{C} \leq T_a \leq 85^\circ\text{C}$	—	$\pm 150$	—	ppm / °C		
Current consumption during operation	$I_{SS1}$	$V_{IN} = V_{OUT(S)} + 1.0 \text{ V}$ , ON/OFF pin = ON, no load	—	80	160	μA	2	
Current consumption during shutdown	$I_{SS2}$	$V_{IN} = V_{OUT(S)} + 1.0 \text{ V}$ , ON/OFF pin = OFF, no load	—	0.1	1.0			
Input voltage	$V_{IN}$	—	2.0	—	6.5	V	—	
Shutdown pin input voltage "H"	$V_{SH}$	$V_{IN} = V_{OUT(S)} + 1.0 \text{ V}$ , $R_L = 1.0 \text{ k}\Omega$	1.5	—	—			4
Shutdown pin input voltage "L"	$V_{SL}$	$V_{IN} = V_{OUT(S)} + 1.0 \text{ V}$ , $R_L = 1.0 \text{ k}\Omega$	—	—	0.3			
Shutdown pin input current "H"	$I_{SH}$	$V_{IN} = 6.5 \text{ V}$ , $V_{ON/OFF} = 6.5 \text{ V}$	-0.1	—	0.1	μA		
Shutdown pin input current "L"	$I_{SL}$	$V_{IN} = 6.5 \text{ V}$ , $V_{ON/OFF} = 0 \text{ V}$	-0.1	—	0.1			
Ripple rejection	RR	$V_{IN} = V_{OUT(S)} + 1.0 \text{ V}$ , $f = 1.0 \text{ kHz}$ , $\Delta V_{rip} = 0.5 \text{ V}_{rms}$ , $I_{OUT} = 100 \text{ mA}$	$1.5 \text{ V} \leq V_{OUT(S)} \leq 3.0 \text{ V}$	—	70	—	dB	5
			$3.1 \text{ V} \leq V_{OUT(S)} \leq 5.5 \text{ V}$	—	65	—		
Short-circuit current	$I_{short}$	$V_{IN} = V_{OUT(S)} + 1.0 \text{ V}$ , ON/OFF pin = ON, $V_{OUT} = 0 \text{ V}$	—	350	—	mA	3	
Thermal shutdown detection temperature	$T_{SD}$	Junction temperature	—	150	—	°C	—	
Thermal shutdown release temperature	$T_{SR}$	Junction temperature	—	120	—			

- \*1.  $V_{OUT(S)}$ : Specified output voltage  
 $V_{OUT(E)}$ : Actual output voltage at the fixed load  
 The output voltage when fixing  $I_{OUT}(= 100 \text{ mA})$  and inputting  $V_{OUT(S)} + 1.0 \text{ V}$
- \*2. The output current at which the output voltage becomes 95% of  $V_{OUT(E)}$  after gradually increasing the output current.
- \*3.  $V_{drop} = V_{IN1} - (V_{OUT3} \times 0.98)$   
 $V_{OUT3}$  is the output voltage when  $V_{IN} = V_{OUT(S)} + 1.0 \text{ V}$  and  $I_{OUT} = 300 \text{ mA}$ .  
 $V_{IN1}$  is the input voltage at which the output voltage becomes 98% of  $V_{OUT3}$  after gradually decreasing the input voltage.
- \*4. The change in temperature [ $\text{mV}/^\circ\text{C}$ ] is calculated using the following equation.  

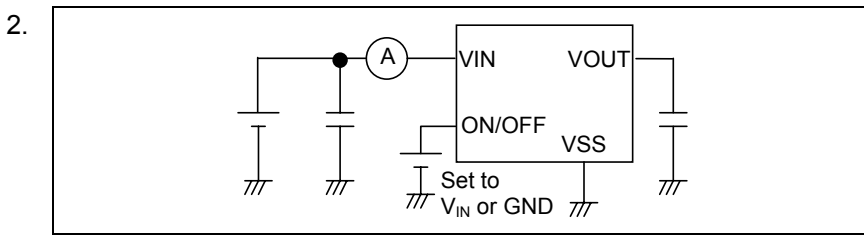
$$\frac{\Delta V_{OUT}}{\Delta T_a} [\text{mV}/^\circ\text{C}]^{\ast 1} = V_{OUT(S)} [\text{V}]^{\ast 2} \times \frac{\Delta V_{OUT}}{\Delta T_a \bullet V_{OUT}} [\text{ppm}/^\circ\text{C}]^{\ast 3} \div 1000$$
  - \*1. The change in temperature of the output voltage
  - \*2. Specified output voltage
  - \*3. Output voltage temperature coefficient
- \*5. The output current can be at least this value.  
 Due to restrictions on the package power dissipation, this value may not be satisfied. Attention should be paid to the power dissipation of the package when the output current is large.  
 This specification is guaranteed by design.



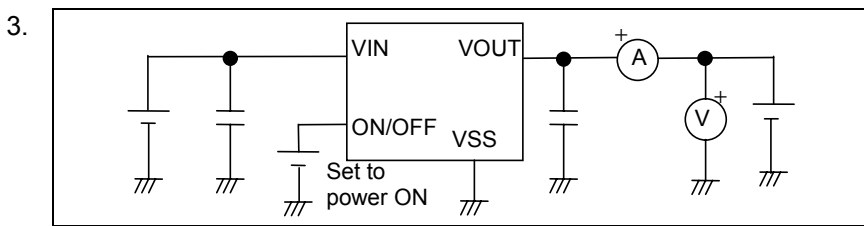
■ **Test Circuits**



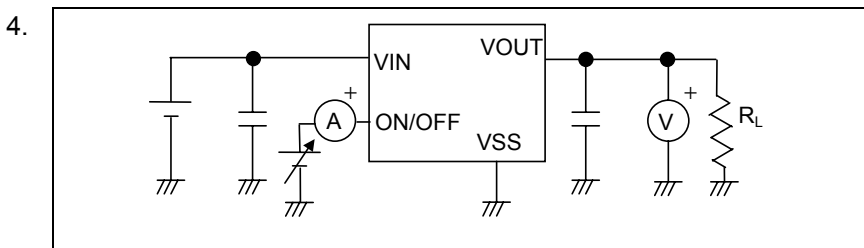
**Figure 5**



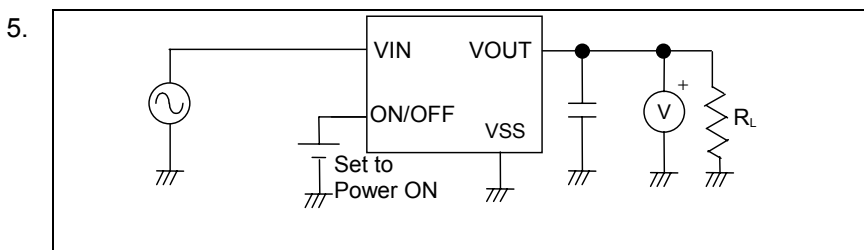
**Figure 6**



**Figure 7**

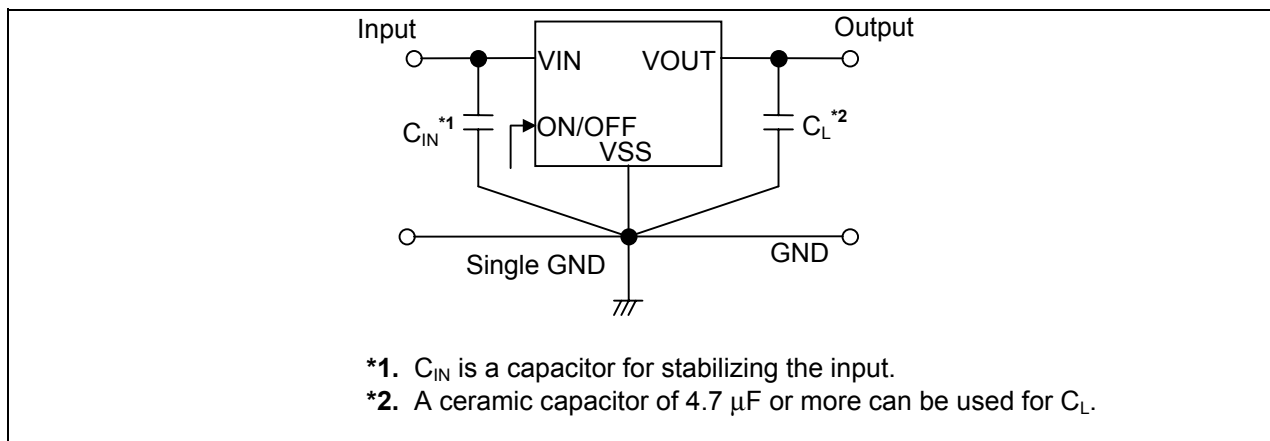


**Figure 8**



**Figure 9**

■ **Standard Circuit**



**Figure 10**

**Caution** The above connection diagram and constant will not guarantee successful operation. Perform thorough evaluation using the actual application to set the constant.

■ **Application Conditions**

Input capacitor ( $C_{IN}$ ): 4.7  $\mu\text{F}$  or more  
 Output capacitor ( $C_L$ ): 4.7  $\mu\text{F}$  or more  
 ESR of output capacitor: 0.5  $\Omega$  or less

**Caution** A general series regulator may oscillate, depending on the external components selected. Check that no oscillation occurs with the application using the above capacitor.

■ **Selection of Input and Output Capacitors ( $C_{IN}$ ,  $C_L$ )**

The S-1170 Series requires an output capacitor between the VOUT and VSS pins for phase compensation. A ceramic capacitor with a capacitance of 4.7  $\mu\text{F}$  or more provides a stable operation in all temperature ranges. When using an OS capacitor, tantalum capacitor, or aluminum electrolytic capacitor, a ceramic capacitor with a capacitance of 4.7  $\mu\text{F}$  or more and an ESR of 0.5  $\Omega$  or less is required.

The output overshoot and undershoot values, which are transient response characteristics, vary depending on the output capacitor value. The required capacitance value for the input capacitor differs depending on the application.

The recommended application values are,  $C_{IN} = 4.7 \mu\text{F}$  or more and  $C_L = 4.7 \mu\text{F}$  or more, however, perform a thorough evaluation using the actual device, including evaluation of temperature characteristics.

## ■ Explanation of Terms

### 1. Low dropout voltage regulator

The low dropout voltage regulator is a voltage regulator whose dropout voltage is low due to its built-in low on-resistance transistor.

### 2. Low ESR

A capacitor whose ESR (Equivalent Series Resistance) is low. The S-1170 Series enables use of a low ESR capacitor, such as a ceramic capacitor, for the output-side capacitor  $C_L$ . A capacitor whose ESR is  $0.5 \Omega$  or less can be used.

### 3. Output voltage ( $V_{OUT}$ )

The accuracy of the output voltage is ensured at  $\pm 1.0\%$  under the specified conditions of fixed input voltage<sup>\*1</sup>, fixed output current, and fixed temperature.

\*1. Differs depending the product.

**Caution** If the above conditions change, the output voltage value may vary and exceed the accuracy range of the output voltage. Please see the electrical characteristics and attached characteristics data for details.

### 4. Line regulation $\left( \frac{\Delta V_{OUT1}}{\Delta V_{IN} \bullet V_{OUT}} \right)$

Indicates the dependency of the output voltage on the input voltage. That is, the values show how much the output voltage changes due to a change in the input voltage with the output current remaining unchanged.

### 5. Load regulation ( $\Delta V_{OUT2}$ )

Indicates the dependency of the output voltage on the output current. That is, the values show how much the output voltage changes due to a change in the output current with the input voltage remaining unchanged.

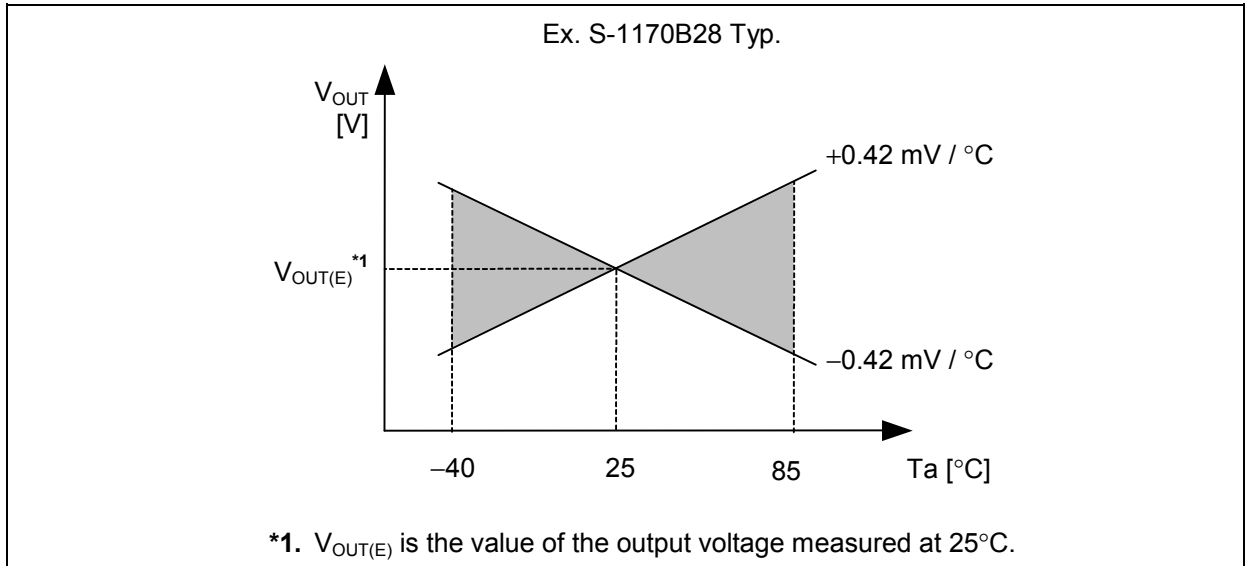
### 6. Dropout voltage ( $V_{drop}$ )

Indicates the difference between the input voltage  $V_{IN1}$ , which is the input voltage ( $V_{IN}$ ) at the point where the output voltage has fallen to 98% of the output voltage value  $V_{OUT3}$  after  $V_{IN}$  was gradually decreased from  $V_{IN} = V_{OUT(S)} + 1.0 \text{ V}$ , and the output voltage at that point ( $V_{OUT3} \times 0.98$ ).

$$V_{drop} = V_{IN1} - (V_{OUT3} \times 0.98)$$

7. Temperature coefficient of output voltage  $\left( \frac{\Delta V_{OUT}}{\Delta T_a \bullet V_{OUT}} \right)$

The shadowed area in **Figure 11** is the range where  $V_{OUT}$  varies in the operating temperature range when the temperature coefficient of the output voltage is  $\pm 150$  ppm/ $^{\circ}\text{C}$ .



**Figure 11**

A change in the temperature of the output voltage [mV/ $^{\circ}\text{C}$ ] is calculated using the following equation.

$$\frac{\Delta V_{OUT}}{\Delta T_a} [\text{mV}/^{\circ}\text{C}]^{*1} = V_{OUT(S)} [\text{V}]^{*2} \times \frac{\Delta V_{OUT}}{\Delta T_a \bullet V_{OUT}} [\text{ppm}/^{\circ}\text{C}]^{*3} \div 1000$$

- \*1. Change in temperature of output voltage
- \*2. Specified output voltage
- \*3. Output voltage temperature coefficient

■ Operation

1. Basic operation

Figure 12 shows the block diagram of the S-1170 Series.

The error amplifier compares the reference voltage ( $V_{ref}$ ) with  $V_{fb}$ , which is the output voltage resistance-divided by feedback resistors  $R_s$  and  $R_f$ . It supplies the output transistor with the gate voltage necessary to ensure a certain output voltage free of any fluctuations of input voltage and temperature.

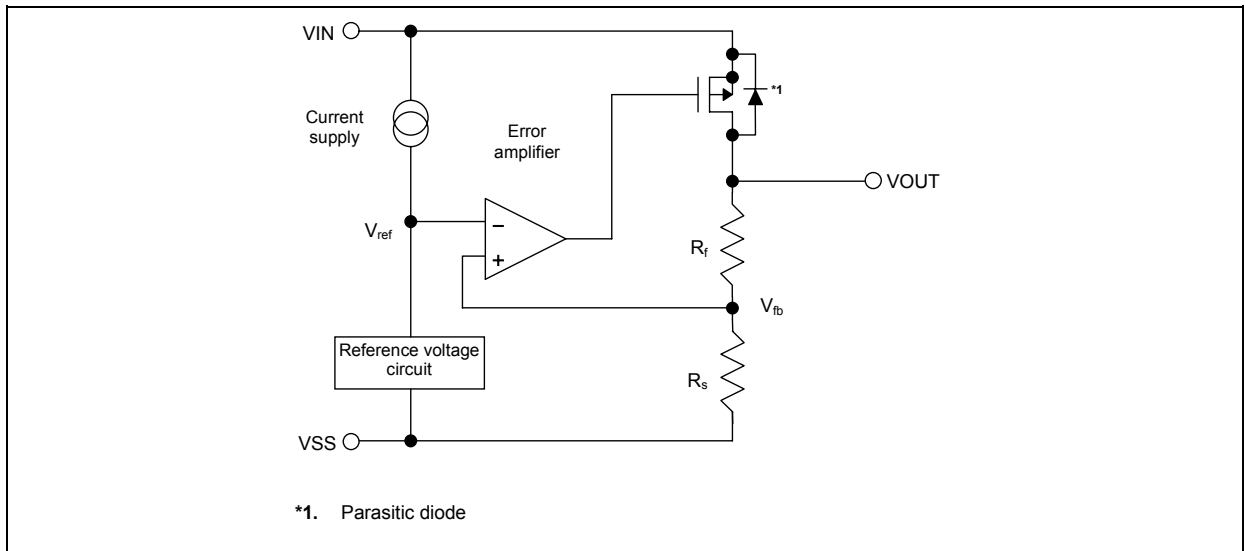


Figure 12

2. Output transistor

The S-1170 Series uses a low on-resistance P-channel MOS FET as the output transistor. Be sure that  $V_{OUT}$  does not exceed  $V_{IN} + 0.3$  V to prevent the voltage regulator from being damaged due to inverse current flowing from VOUT pin through a parasitic diode to VIN pin.

3. Shutdown pin (ON/OFF pin)

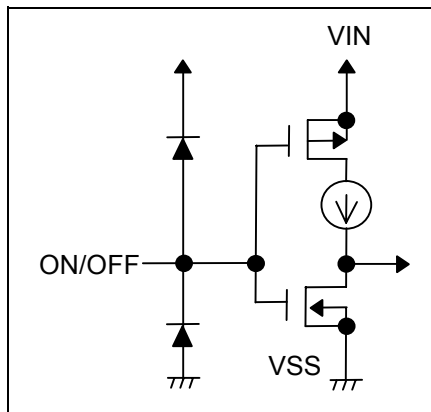
This pin starts and stops the regulator.

When the ON/OFF pin is set to the shutdown level, the operation of all internal circuits stops, and the built-in P-channel MOS FET output transistor between the VIN pin and VOUT pin is turned off to substantially reduce the current consumption. The VOUT pin becomes the V<sub>SS</sub> level due to the internally divided resistance of several hundreds kΩ between the VOUT pin and VSS pin.

The structure of the ON/OFF pin is as shown in **Figure 13**. Since the ON/OFF pin is neither pulled down nor pulled up internally, do not use it in the floating state. In addition, note that the current consumption increases if a voltage of 0.3 V to V<sub>IN</sub> – 0.3 V is applied to the ON/OFF pin. When the ON/OFF pin is not used, connect it to the VSS pin if the logic type is “A” and to the VIN pin if it is “B”.

**Table 6**

Logic Type	ON/OFF Pin	Internal Circuits	VOUT Pin Voltage	Current Consumption
A	“L”: Power on	Operating	Set value	I <sub>SS1</sub>
A	“H”: Power off	Stopped	V <sub>SS</sub> level	I <sub>SS2</sub>
B	“L”: Power off	Stopped	V <sub>SS</sub> level	I <sub>SS2</sub>
B	“H”: Power on	Operating	Set value	I <sub>SS1</sub>



**Figure 13**

#### 4. Thermal shutdown circuit

The S-1170 Series implements a thermal shutdown circuit to protect the device from damage due to overheating. When the junction temperature rises to 150°C (typ.), the thermal shutdown circuit operates and the regulator operation stops. When the junction temperature drops to 120°C (typ.), the thermal shutdown circuit is released and the regulator operation resumes.

If the thermal shutdown circuit starts operating due to self-heating, the regulator operation stops and the output voltage falls. When the regulator operation has stopped, no self-heat is generated and the temperature of the IC is lowered. When the temperature has dropped, the thermal shutdown circuit is released, the regulator operation resumes, and self-heat is generated again. By repeating this procedure, the output voltage waveform forms pulses. This phenomenon, stopping and resuming the regulator operation, continues until the internal power consumption is reduced by reducing either the input voltage or output current or both, or the ambient temperature is lowered.

**Table 7**

Thermal Shutdown Circuit	VOUT Pin Voltage
Operating: 150°C (typ.)	V <sub>SS</sub> level
Released: 120°C (typ.)	Set value

## ■ Precautions

- Wiring patterns for the VIN, VOUT and GND pins should be designed so that the impedance is low. When mounting an output capacitor between the VOUT and VSS pins ( $C_L$ ) and a capacitor for stabilizing the input between VIN and VSS pins ( $C_{IN}$ ), the distance from the capacitors to these pins should be as short as possible.
- Note that the output voltage may increase when a series regulator is used at low load current (1.0 mA or less).
- Generally a series regulator may cause oscillation, depending on the selection of external parts. The following conditions are recommended for this IC. However, be sure to perform sufficient evaluation under the actual usage conditions for selection, including evaluation of temperature characteristics.

Input capacitor ( $C_{IN}$ ):	4.7 $\mu$ F or more
Output capacitor ( $C_L$ ):	4.7 $\mu$ F or more
Equivalent series resistance (ESR):	0.5 $\Omega$ or less

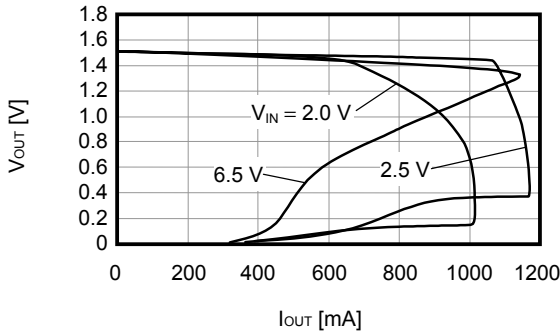
- The voltage regulator may oscillate when the impedance of the power supply is high and the input capacitor is small or an input capacitor is not connected.
- The application conditions for the input voltage, output voltage, and load current should not exceed the package power dissipation.
- Do not apply an electrostatic discharge to this IC that exceeds the performance ratings of the built-in electrostatic protection circuit.
- In determining the output current, attention should be paid to the output current value specified in **Table 5** in the electrical characteristics and footnote \*5) of the table.
- SII claims no responsibility for any disputes arising out of or in connection with any infringement by products including this IC of patents owned by a third party.



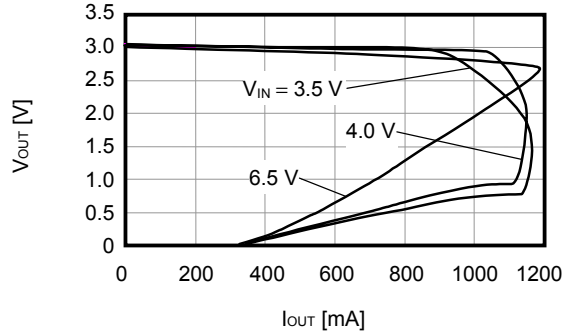
■ Typical Characteristics

(1) Output Voltage vs. Output current (when load current increases)

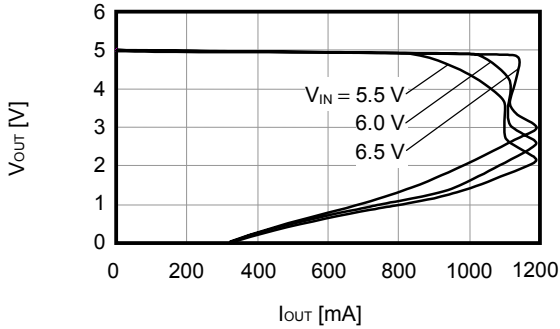
S-1170B15 (Ta = 25°C)



S-1170B30 (Ta = 25°C)



S-1170B50 (Ta = 25°C)

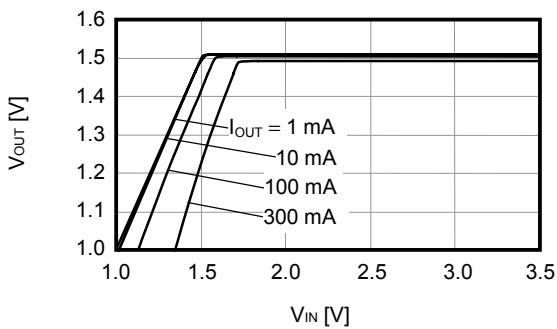


**Remark** In determining the output current, attention should be paid to the following.

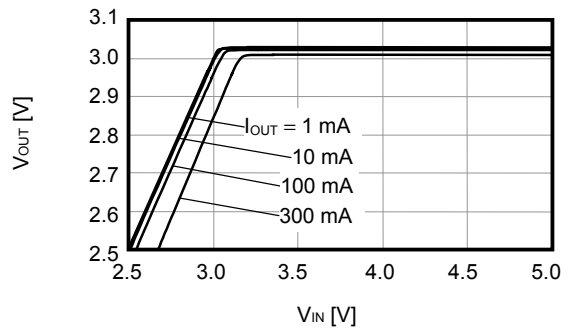
- 1) The minimum output current value and footnote \*5 in the electrical characteristics
- 2) The package power dissipation

(2) Output voltage vs. Input voltage

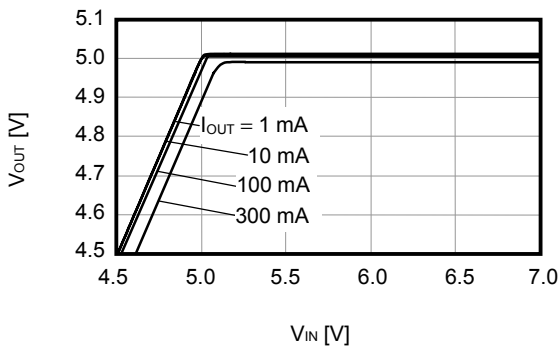
S-1170B15 (Ta = 25°C)



S-1170B30 (Ta = 25°C)

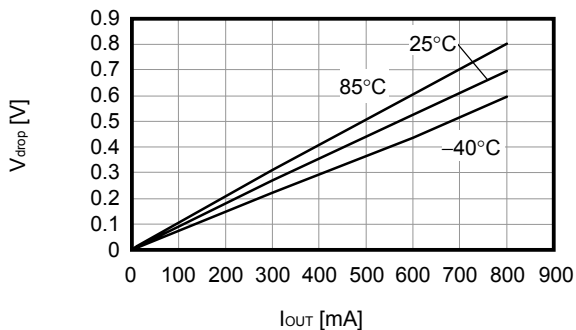


S-1170B50 (Ta = 25°C)

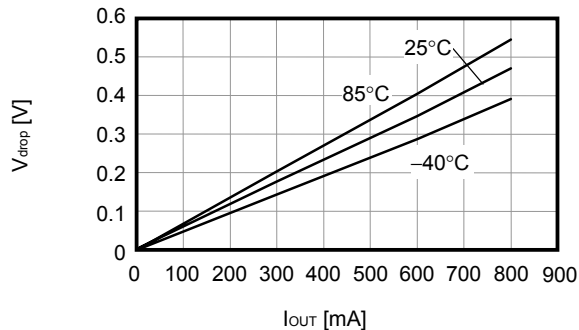


(3) Dropout voltage vs. Output current

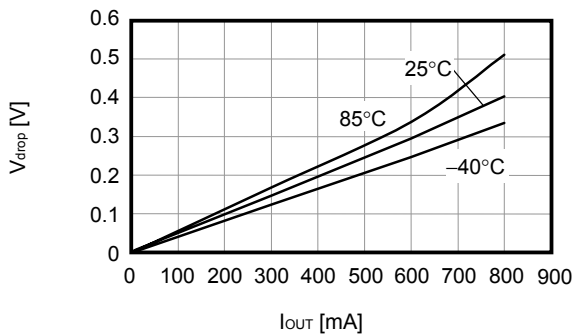
S-1170B15



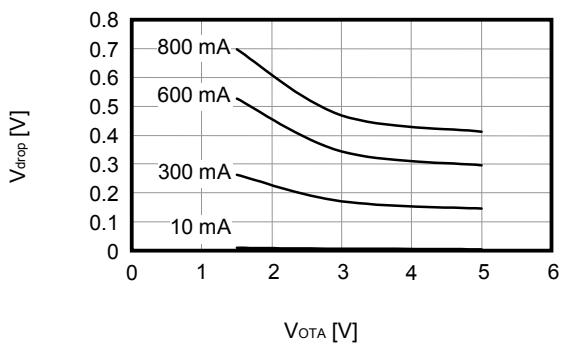
S-1170B30



S-1170B50

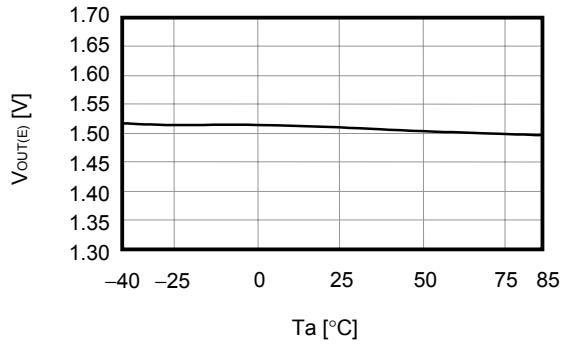


(4) Dropout voltage vs. Set output voltage

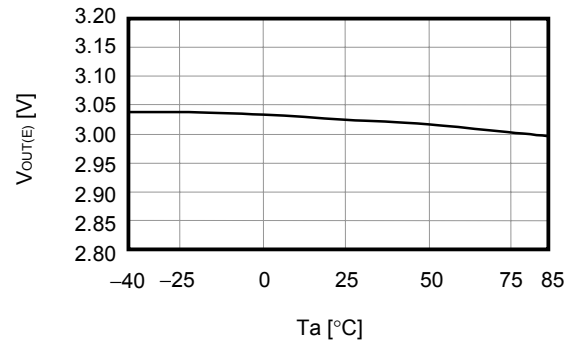


(5) Output voltage vs. Ambient temperature

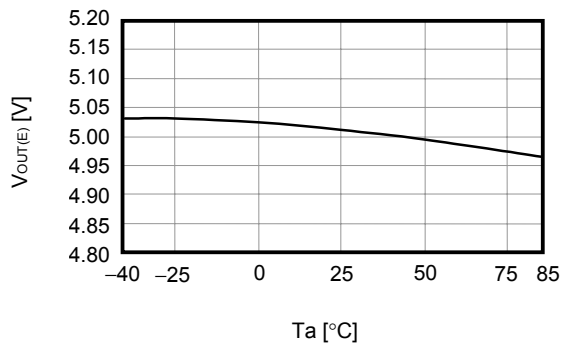
S-1170B15 ( $I_{OUT} = 10 \text{ mA}$ )



S-1170B30 ( $I_{OUT} = 10 \text{ mA}$ )

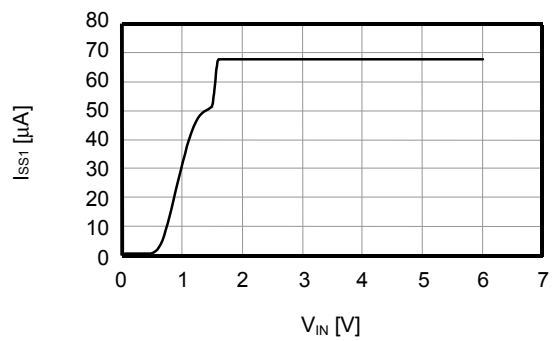


S-1170B50 ( $I_{OUT} = 10 \text{ mA}$ )

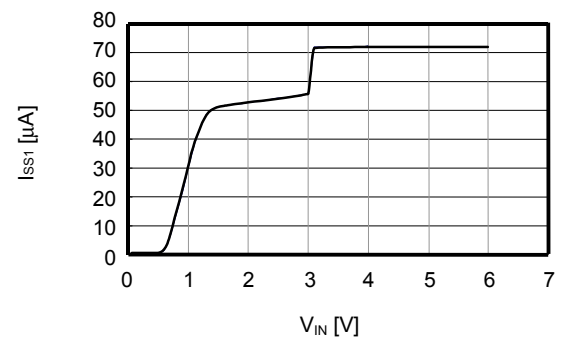


(6) Current consumption vs. Input voltage

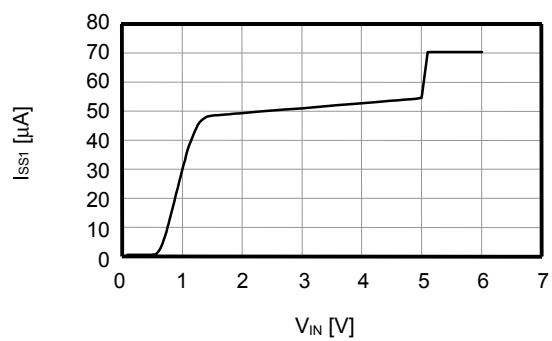
S-1170B15 ( $T_a = 25^\circ\text{C}$ )



S-1170B30 ( $T_a = 25^\circ\text{C}$ )



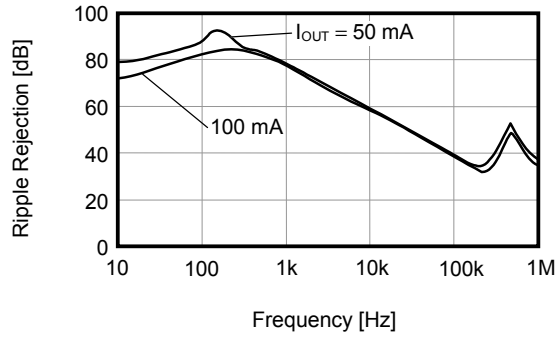
S-1170B50 ( $T_a = 25^\circ\text{C}$ )



(7) Ripple rejection

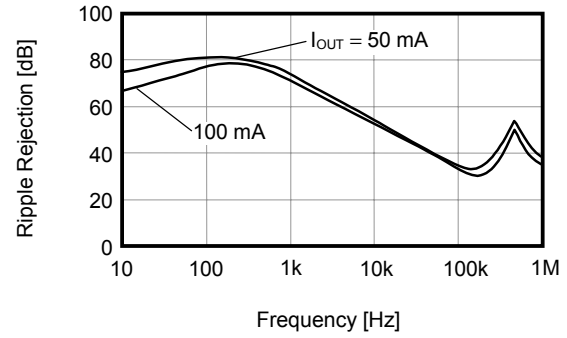
S-1170B15 ( $T_a = 25^\circ\text{C}$ )

$V_{IN} = 2.5\text{ V}$ ,  $C_{OUT} = 4.7\ \mu\text{F}$



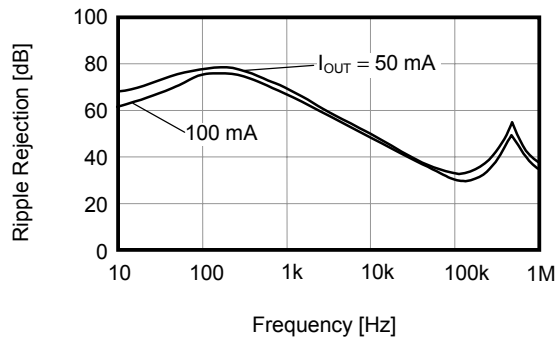
S-1170B30 ( $T_a = 25^\circ\text{C}$ )

$V_{IN} = 4.0\text{ V}$ ,  $C_{OUT} = 4.7\ \mu\text{F}$



S-1170B50 ( $T_a = 25^\circ\text{C}$ )

$V_{IN} = 6.0\text{ V}$ ,  $C_{OUT} = 4.7\ \mu\text{F}$

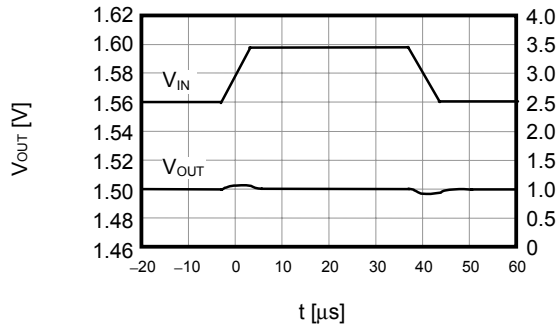


■ Reference Data

(1) Input transient response characteristics

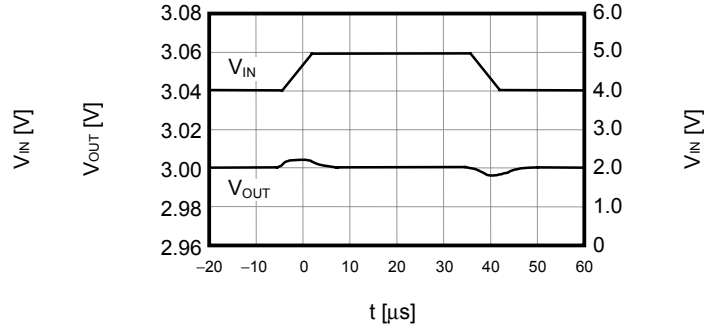
S-1170B15

$I_{OUT} = 100\text{ mA}$ ,  $t_r = t_f = 5.0\ \mu\text{s}$ ,  $C_{OUT} = 4.7\ \mu\text{F}$ ,  $C_{IN} = 4.7\ \mu\text{F}$



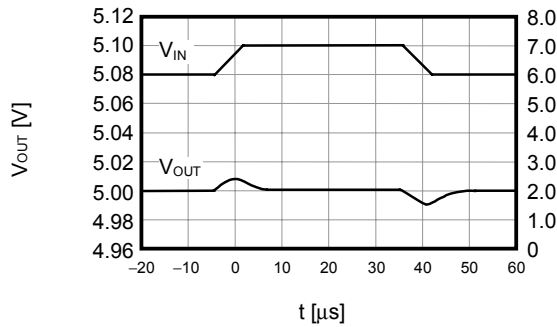
S-1170B30

$I_{OUT} = 100\text{ mA}$ ,  $t_r = t_f = 5.0\ \mu\text{s}$ ,  $C_{OUT} = 4.7\ \mu\text{F}$ ,  $C_{IN} = 4.7\ \mu\text{F}$



S-1170B50

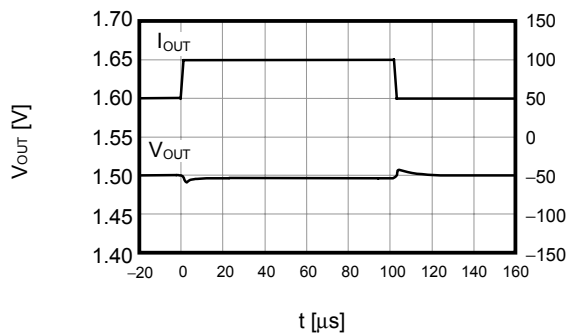
$I_{OUT} = 100\text{ mA}$ ,  $t_r = t_f = 5.0\ \mu\text{s}$ ,  $C_{OUT} = 4.7\ \mu\text{F}$ ,  $C_{IN} = 4.7\ \mu\text{F}$



(2) Load transient response characteristics

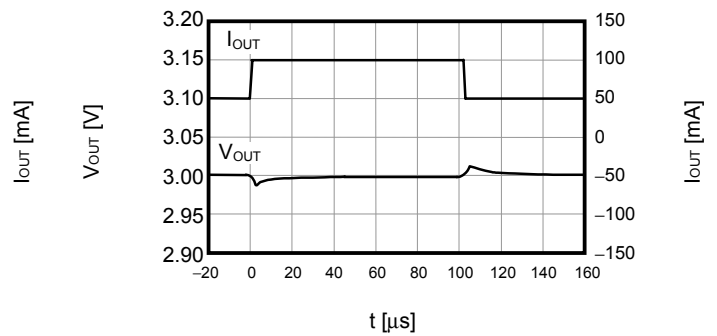
S-1170B15 ( $T_a = 25^\circ\text{C}$ )

$V_{IN} = 2.5\text{ V}$ ,  $C_{OUT} = 4.7\ \mu\text{F}$ ,  $C_{IN} = 4.7\ \mu\text{F}$ ,  $I_{OUT} = 50 \leftrightarrow 100\text{ mA}$



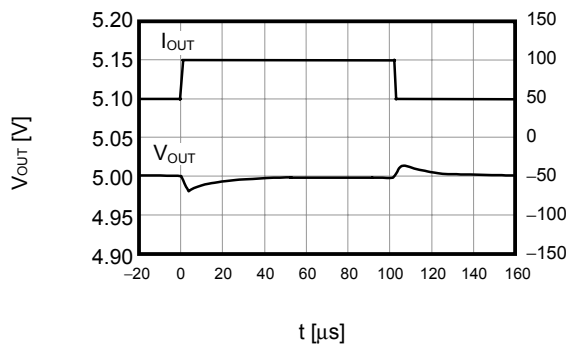
S-1170B30 ( $T_a = 25^\circ\text{C}$ )

$V_{IN} = 4.0\text{ V}$ ,  $C_{OUT} = 4.7\ \mu\text{F}$ ,  $C_{IN} = 4.7\ \mu\text{F}$ ,  $I_{OUT} = 50 \leftrightarrow 100\text{ mA}$



S-1170B50 ( $T_a = 25^\circ\text{C}$ )

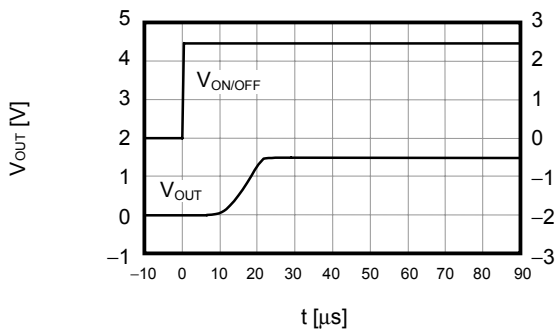
$V_{IN} = 6.0\text{ V}$ ,  $C_{OUT} = 4.7\ \mu\text{F}$ ,  $C_{IN} = 4.7\ \mu\text{F}$ ,  $I_{OUT} = 50 \leftrightarrow 100\text{ mA}$



(3) Shutdown pin transient response characteristics

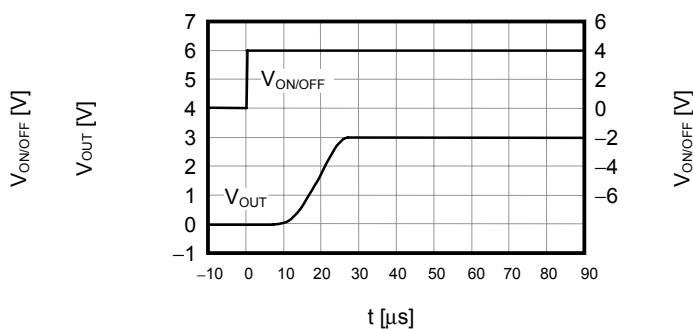
S-1170B15 (Ta = 25°C)

V<sub>IN</sub> = 2.5 V, C<sub>OUT</sub> = 4.7 μF, C<sub>IN</sub> = 4.7 μF, I<sub>OUT</sub> = 100 mA



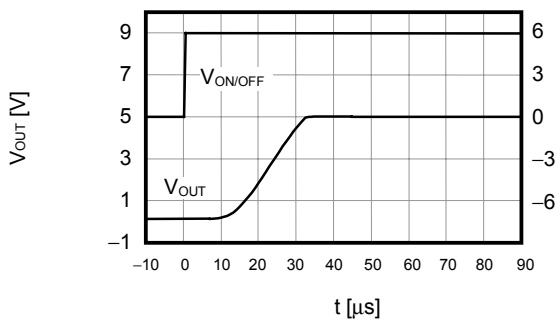
S-1170B30 (Ta = 25°C)

V<sub>IN</sub> = 4.0 V, C<sub>OUT</sub> = 4.7 μF, C<sub>IN</sub> = 4.7 μF, I<sub>OUT</sub> = 100 mA



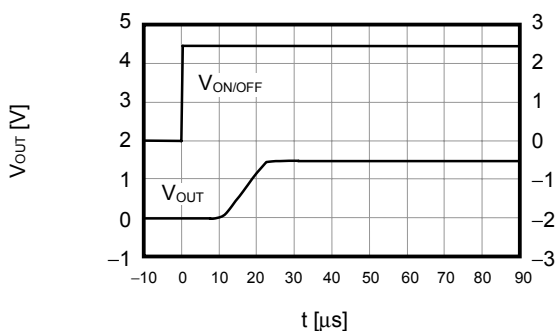
S-1170B50 (Ta = 25°C)

V<sub>IN</sub> = 6.0 V, C<sub>OUT</sub> = 4.7 μF, C<sub>IN</sub> = 4.7 μF, I<sub>OUT</sub> = 100 mA



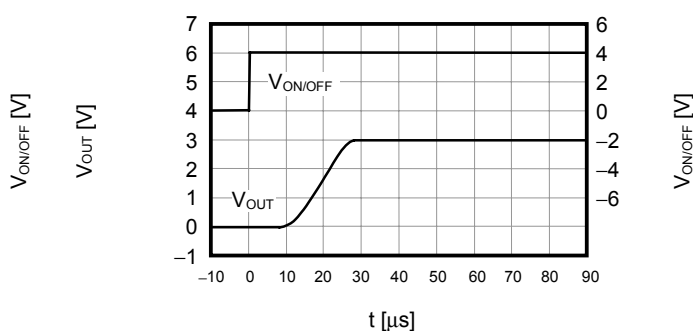
S-1170B15 (Ta = 25°C)

V<sub>IN</sub> = 2.5 V, C<sub>OUT</sub> = 4.7 μF, C<sub>IN</sub> = 4.7 μF, I<sub>OUT</sub> = 300 mA



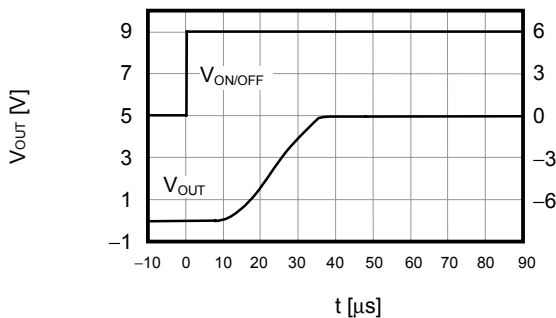
S-1170B30 (Ta = 25°C)

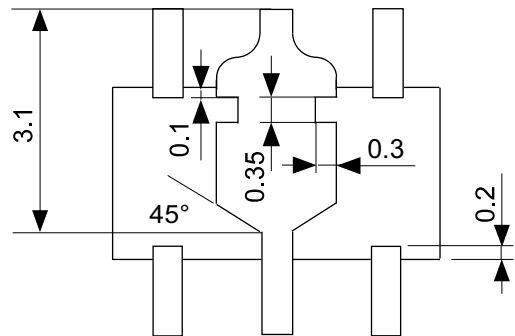
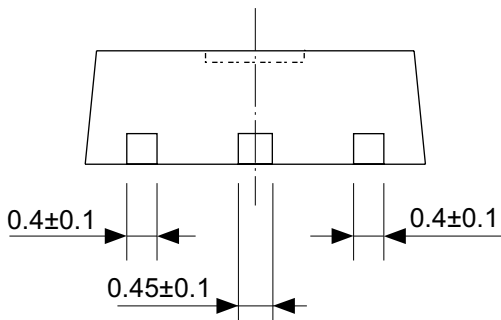
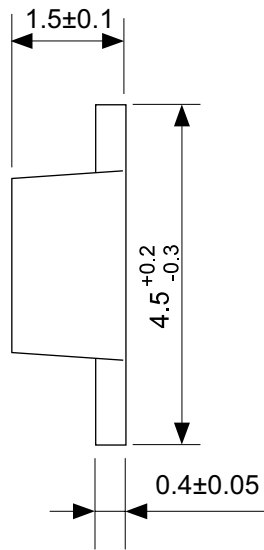
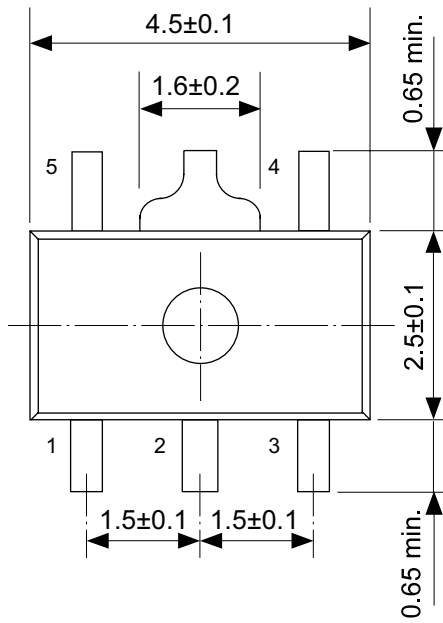
V<sub>IN</sub> = 4.0 V, C<sub>OUT</sub> = 4.7 μF, C<sub>IN</sub> = 4.7 μF, I<sub>OUT</sub> = 300 mA



S-1170B50 (Ta = 25°C)

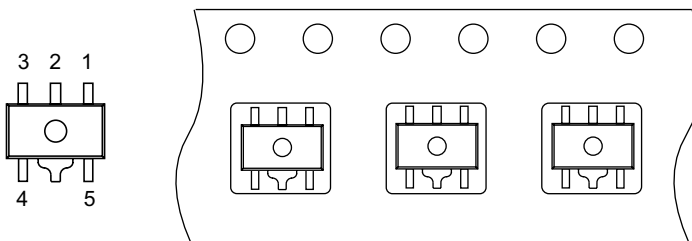
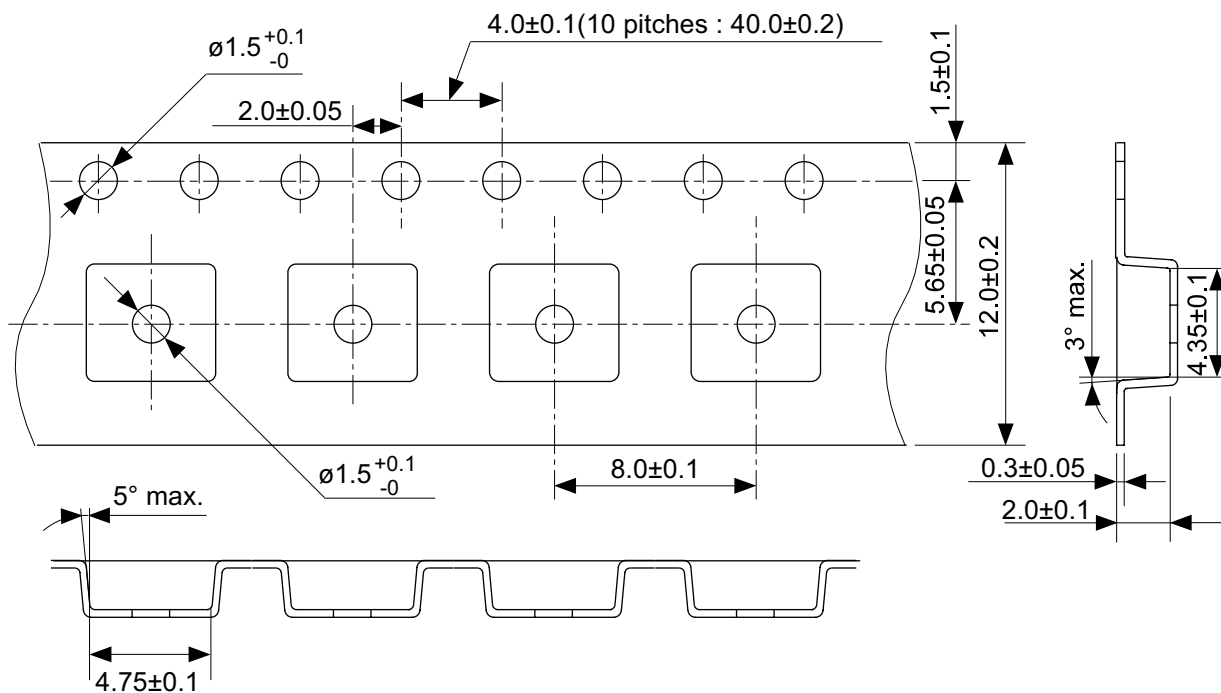
V<sub>IN</sub> = 6.0 V, C<sub>OUT</sub> = 4.7 μF, C<sub>IN</sub> = 4.7 μF, I<sub>OUT</sub> = 300 mA





No. UP005-A-P-SD-1.1

TITLE	SOT895-A-PKG Dimensions
No.	UP005-A-P-SD-1.1
SCALE	
UNIT	mm
Seiko Instruments Inc.	

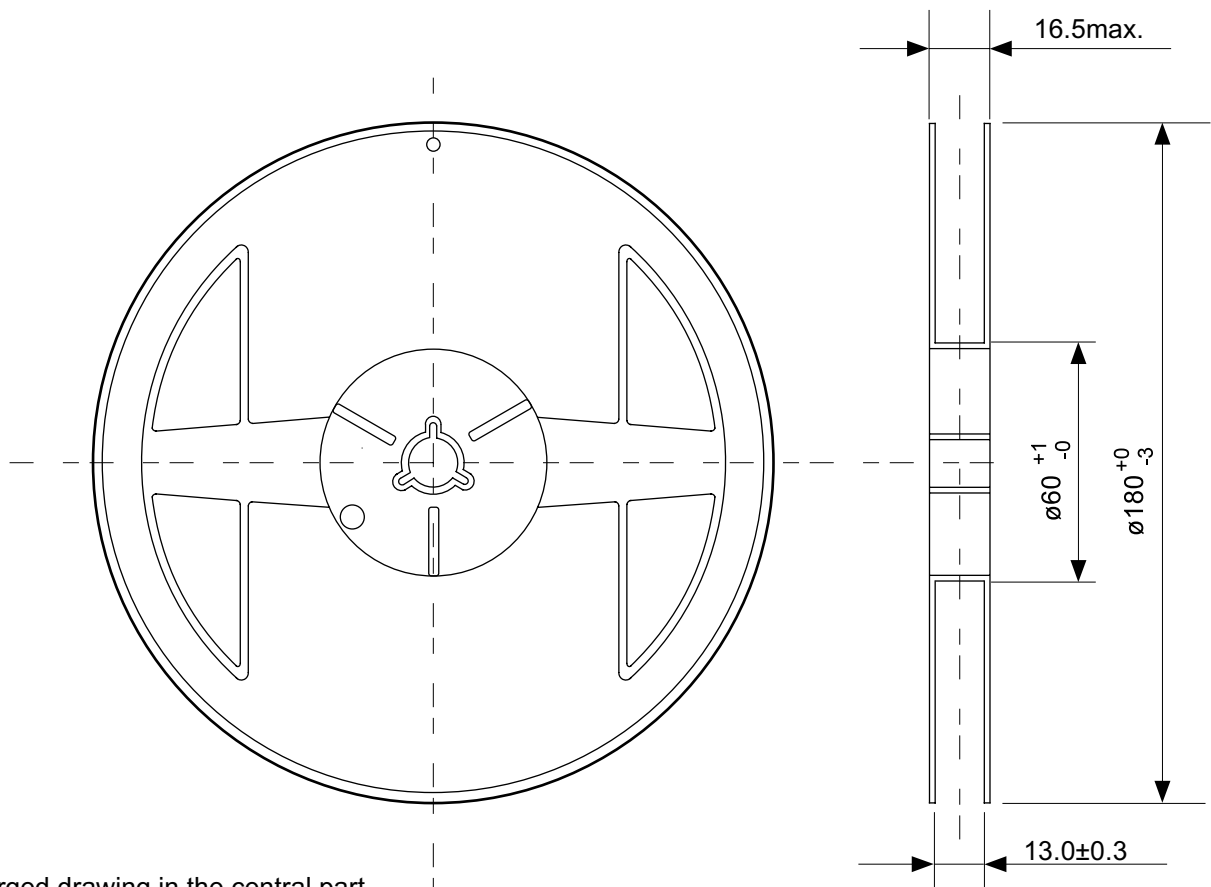


→  
Feed direction

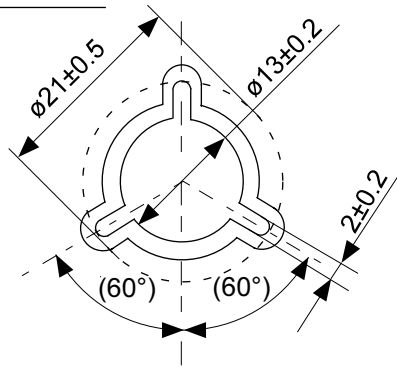
No. UP005-A-C-SD-1.1

TITLE	SOT895-A-Carrier Tape
No.	UP005-A-C-SD-1.1
SCALE	
UNIT	mm
Seiko Instruments Inc.	



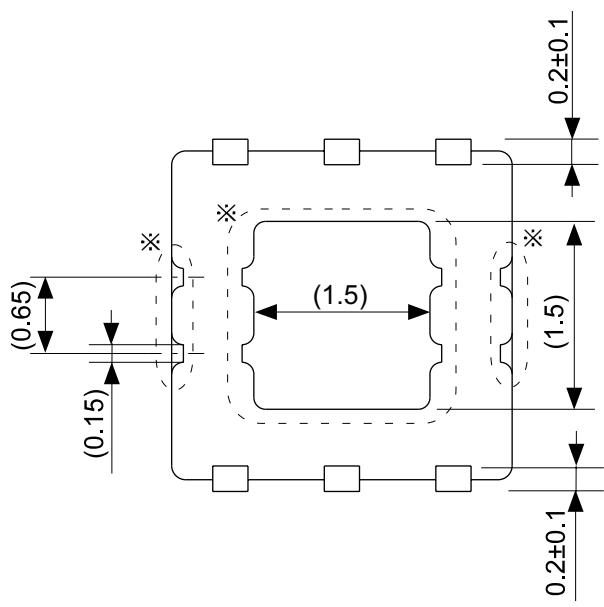
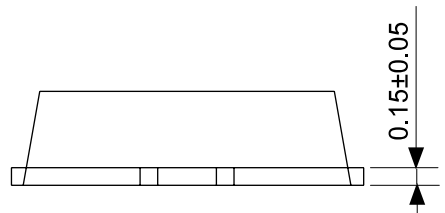
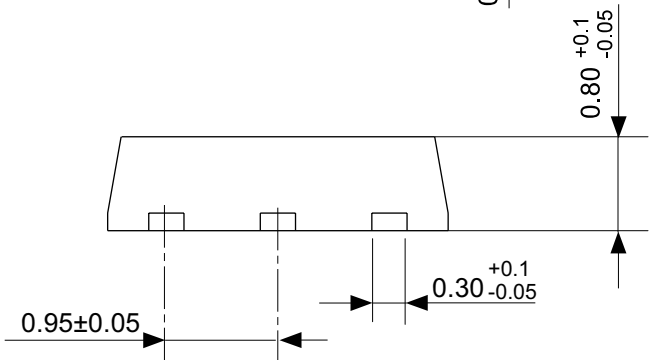
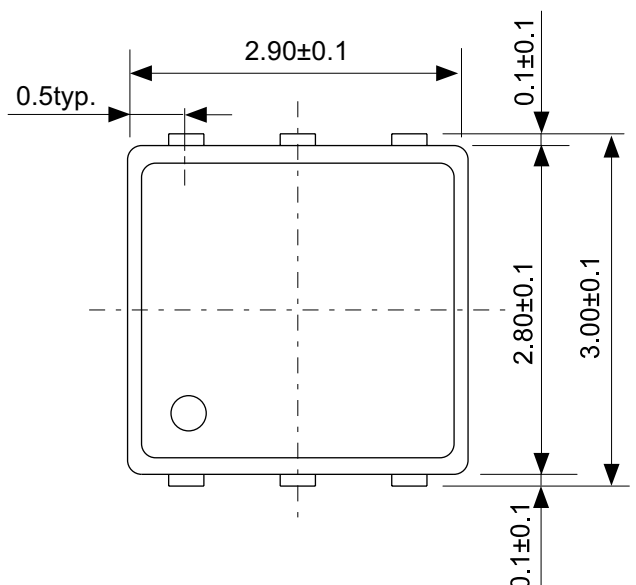


Enlarged drawing in the central part



No. UP005-A-R-SD-1.1

TITLE	SOT895-A-Reel		
No.	UP005-A-R-SD-1.1		
SCALE		QTY.	1,000
UNIT	mm		
Seiko Instruments Inc.			

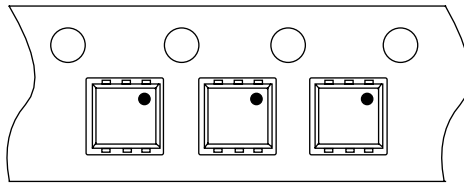
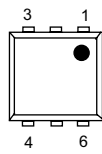
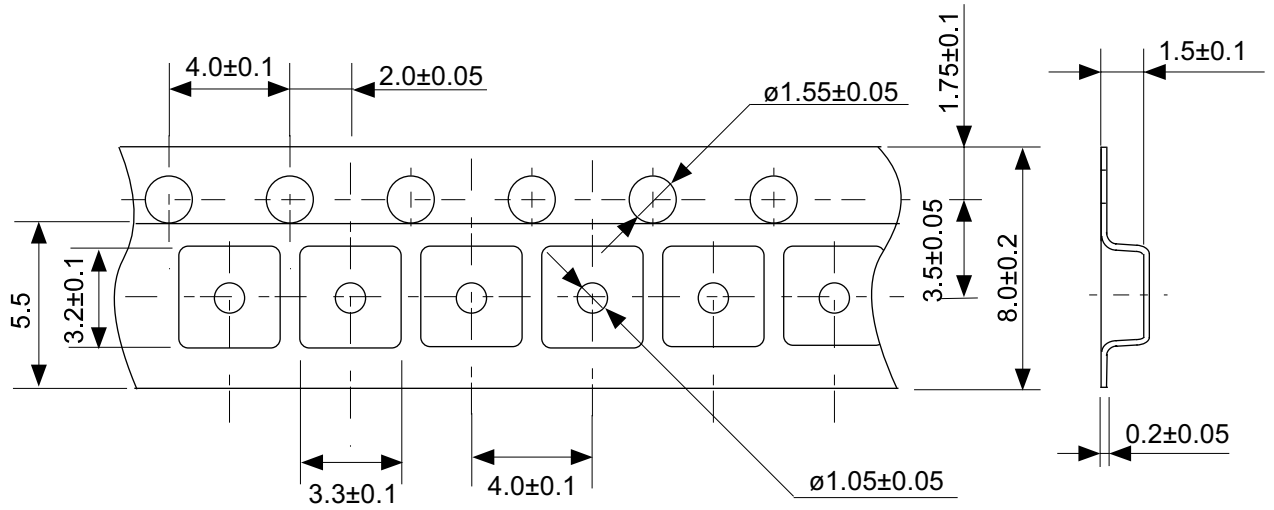


No. PD006-A-P-SD-4.0

※ The exposed thermal die pad has different electric potential depending on the product. Confirm specifications of each product. Do not use it as the function of electrode.

TITLE	HSON6A-A-PKG Dimensions
No.	PD006-A-P-SD-4.0
SCALE	
UNIT	mm

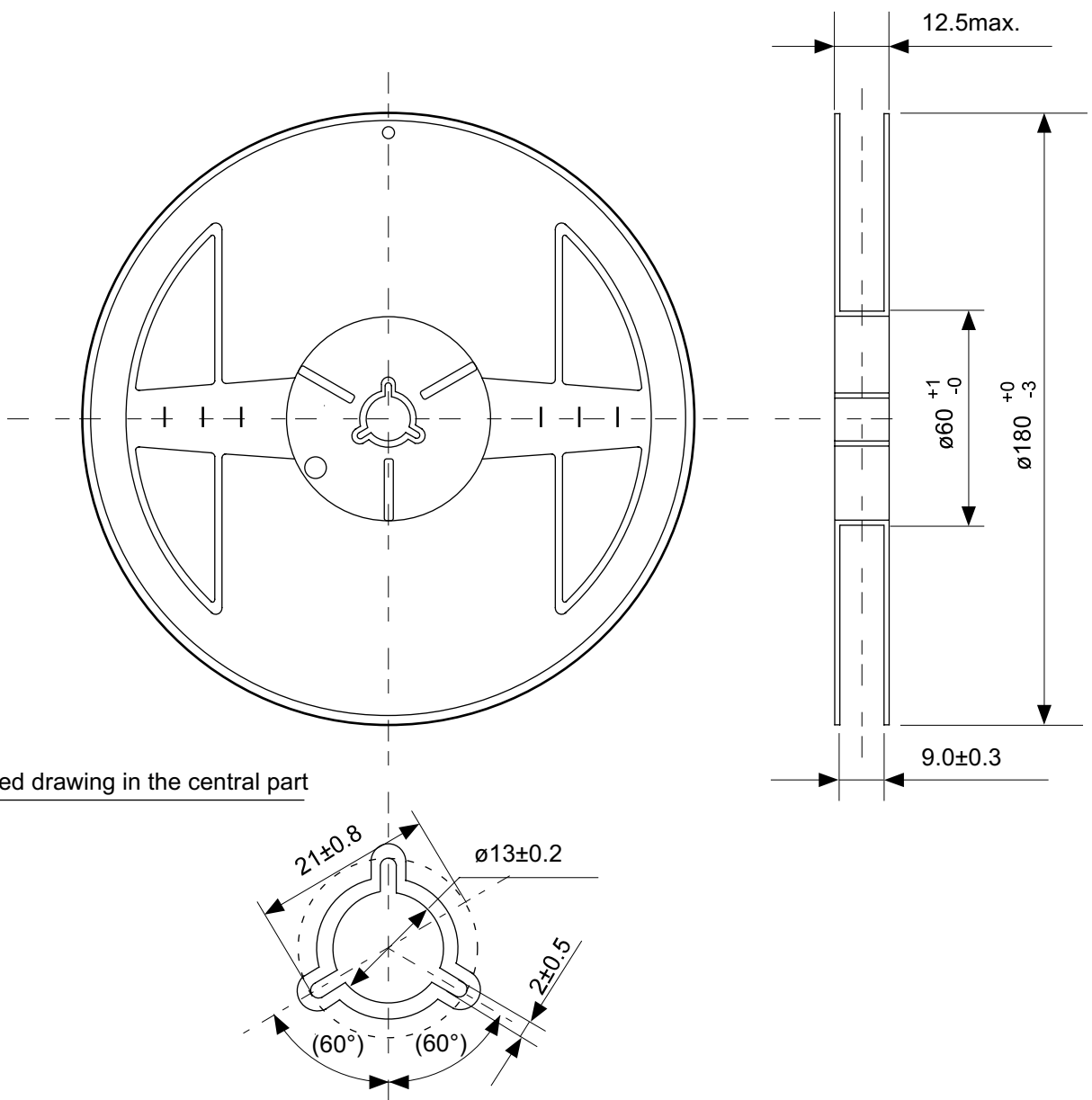
Seiko Instruments Inc.



→  
Feed direction

No. PD006-A-C-SD-2.0

TITLE	HSO6A-A-Carrier Tape
No.	PD006-A-C-SD-2.0
SCALE	
UNIT	mm
Seiko Instruments Inc.	



Enlarged drawing in the central part

No. PD006-A-R-SD-1.0

TITLE	HSON6A-A-Reel		
No.	PD006-A-R-SD-1.0		
SCALE		QTY.	3000
UNIT	mm		
Seiko Instruments Inc.			

- The information described herein is subject to change without notice.
- Seiko Instruments Inc. is not responsible for any problems caused by circuits or diagrams described herein whose related industrial properties, patents, or other rights belong to third parties. The application circuit examples explain typical applications of the products, and do not guarantee the success of any specific mass-production design.
- When the products described herein are regulated products subject to the Wassenaar Arrangement or other agreements, they may not be exported without authorization from the appropriate governmental authority.
- Use of the information described herein for other purposes and/or reproduction or copying without the express permission of Seiko Instruments Inc. is strictly prohibited.
- The products described herein cannot be used as part of any device or equipment affecting the human body, such as exercise equipment, medical equipment, security systems, gas equipment, or any apparatus installed in airplanes and other vehicles, without prior written permission of Seiko Instruments Inc.
- Although Seiko Instruments Inc. exerts the greatest possible effort to ensure high quality and reliability, the failure or malfunction of semiconductor products may occur. The user of these products should therefore give thorough consideration to safety design, including redundancy, fire-prevention measures, and malfunction prevention, to prevent any accidents, fires, or community damage that may ensue.