

Dual Enhancement Mode MOSFET (N- and P-Channel)

Features

- N-Channel
20V/3A,
 $R_{DS(ON)}=50m\Omega(\text{typ.}) @ V_{GS}=4.5V$
 $R_{DS(ON)}=65m\Omega(\text{typ.}) @ V_{GS}=2.5V$
- P-Channel
-20V/-2A,
 $R_{DS(ON)}=90m\Omega(\text{typ.}) @ V_{GS}=-4.5V$
 $R_{DS(ON)}=130m\Omega(\text{typ.}) @ V_{GS}=-2.5V$
- Super High Dense Cell Design
- Reliable and Rugged
- Lead Free and Green Devices Available (RoHS Compliant)

Applications

- Power Management in Notebook Computer, Portable Equipment and Battery Powered Systems

Pin Description



Top View of JSOT-6

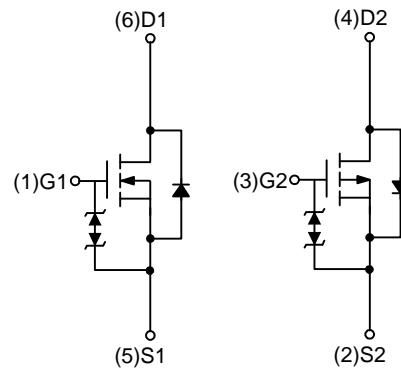

N-Channel MOSFET

P-Channel MOSFET

Ordering and Marking Information

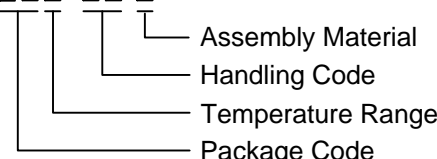
<p>APM2701 □□□-□□□</p>  <p>Assembly Material Handling Code Temperature Range Package Code</p>	<p>Package Code CG : JSOT-6 Operating Junction Temperature Range C : -55 to 150 °C Handling Code TR : Tape & Reel Assembly Material G : Halogen and Lead Free Device</p>
<p>APM2701 CG : M2701 XXXXX</p>	<p>XXXXX - Date Code</p>

Note: ANPEC lead-free products contain molding compounds/die attach materials and 100% matte tin plate termination finish; which are fully compliant with RoHS. ANPEC lead-free products meet or exceed the lead-free requirements of IPC/JEDEC J-STD-020D for MSL classification at lead-free peak reflow temperature. ANPEC defines "Green" to mean lead-free (RoHS compliant) and halogen free (Br or Cl does not exceed 900ppm by weight in homogeneous material and total of Br and Cl does not exceed 1500ppm by weight).

ANPEC reserves the right to make changes to improve reliability or manufacturability without notice, and advise customers to obtain the latest version of relevant information to verify before placing orders.

Absolute Maximum Ratings ($T_A = 25^\circ\text{C}$ unless otherwise noted)

Symbol	Parameter	Rating		Unit
		N Channel	P Channel	
V_{DSS}	Drain-Source Voltage	20	-20	V
V_{GSS}	Gate-Source Voltage	± 12	± 12	
I_D^*	Continuous Drain Current	3	-2	A
I_{DM}^*	300 μs Pulsed Drain Current			
$V_{GS}=\pm 4.5\text{V}$		12	-8	
I_S^*	Diode Continuous Forward Current	1	-1	A
T_J	Maximum Junction Temperature	150		$^\circ\text{C}$
T_{STG}	Storage Temperature Range	-55 to 150		
P_D^*	Power Dissipation	$T_A=25^\circ\text{C}$	0.83	W
		$T_A=100^\circ\text{C}$	0.3	
$R_{\theta JA}^*$	Thermal Resistance-Junction to Ambient	150		$^\circ\text{C}/\text{W}$

Note : *Surface Mounted on 1in² pad area, $t \leq 10\text{sec}$.

Electrical Characteristics ($T_A = 25^\circ\text{C}$ unless otherwise noted)

Symbol	Parameter	Test Conditions	APM2701CG			Unit		
			Min.	Typ.	Max.			
Static Characteristics								
BV_{DSS}	Drain-Source Breakdown Voltage	$V_{GS}=0\text{V}, I_{DS}=250\mu\text{A}$	N-Ch	20	-	-	V	
		$V_{GS}=0\text{V}, I_{DS}=-250\mu\text{A}$	P-Ch	-20	-	-		
I_{DSS}	Zero Gate Voltage Drain Current	$V_{DS}=16\text{V}, V_{GS}=0\text{V}$	N-Ch	$T_J=85^\circ\text{C}$	-	-	1	μA
				$T_J=85^\circ\text{C}$	-	-	30	
		$V_{DS}=-16\text{V}, V_{GS}=0\text{V}$	P-Ch	$T_J=85^\circ\text{C}$	-	-	-1	
				$T_J=85^\circ\text{C}$	-	-	-30	
$V_{GS(th)}$	Gate Threshold Voltage	$V_{DS}=V_{GS}, I_{DS}=250\mu\text{A}$	N-Ch	0.45	0.6	1	V	
		$V_{DS}=V_{GS}, I_{DS}=-250\mu\text{A}$	P-Ch	-0.45	-0.6	-1		
I_{GSS}	Gate Leakage Current	$V_{GS}=\pm 10\text{V}, V_{DS}=0\text{V}$	N-Ch	-	-	± 10	μA	
			P-Ch	-	-	± 10		
$R_{DS(ON)}^a$	Drain-Source On-State Resistance	$V_{GS}=4.5\text{V}, I_{DS}=3\text{A}$	N-Ch	-	50	65	m Ω	
		$V_{GS}=-4.5\text{V}, I_{DS}=-2\text{A}$	P-Ch	-	90	120		
		$V_{GS}=2.5\text{V}, I_{DS}=1.7\text{A}$	N-Ch	-	65	90		
		$V_{GS}=-2.5\text{V}, I_{DS}=-1\text{A}$	P-Ch	-	130	180		

Electrical Characteristics (Cont.) ($T_A = 25^\circ\text{C}$ unless otherwise noted)

Symbol	Parameter	Test Conditions	APM2701CG			Unit	
			Min.	Typ.	Max.		
Static Characteristics (Cont.)							
V_{SD}^a	Diode Forward Voltage	$I_{SD}=0.5\text{A}, V_{GS}=0\text{V}$	N-Ch	-	0.7	1.3	V
		$I_{SD}=-0.5\text{A}, V_{GS}=0\text{V}$	P-Ch	-	-0.7	-1.3	
Dynamic Characteristics ^b							
C_{iss}	Input Capacitance	N-Channel $V_{GS}=0\text{V},$ $V_{DS}=10\text{V},$ Frequency=1.0MHz	N-Ch	-	300	-	pF
			P-Ch	-	375	-	
C_{oss}	Output Capacitance	P-Channel $V_{GS}=0\text{V},$ $V_{DS}=-10\text{V},$ Frequency=1.0MHz	N-Ch	-	70	-	
			P-Ch	-	70	-	
C_{rss}	Reverse Transfer Capacitance	N-Channel $V_{GS}=0\text{V},$ $V_{DS}=-10\text{V},$ Frequency=1.0MHz	N-Ch	-	50	-	
			P-Ch	-	50	-	
$t_{d(ON)}$	Turn-on Delay Time	N-Channel $V_{DD}=10\text{V}, R_L=10\Omega,$ $I_{DS}=1\text{A}, V_{GEN}=4.5\text{V},$ $R_G=6\Omega$	N-Ch	-	6	12	ns
			P-Ch	-	6	12	
T_r	Turn-on Rise Time	P-Channel $V_{DD}=-10\text{V}, R_L=10\Omega,$ $I_{DS}=-1\text{A}, V_{GEN}=-4.5\text{V},$ $R_G=6\Omega$	N-Ch	-	14	26	
			P-Ch	-	14	26	
$t_{d(OFF)}$	Turn-off Delay Time	N-Channel $V_{DD}=10\text{V}, R_L=10\Omega,$ $I_{DS}=1\text{A}, V_{GEN}=4.5\text{V},$ $R_G=6\Omega$	N-Ch	-	21	39	
			P-Ch	-	27	50	
T_f	Turn-off Fall Time	P-Channel $V_{DD}=-10\text{V}, R_L=10\Omega,$ $I_{DS}=-1\text{A}, V_{GEN}=-4.5\text{V},$ $R_G=6\Omega$	N-Ch	-	6	12	
			P-Ch	-	5	10	
Gate Charge Characteristics ^b							
Q_g	Total Gate Charge	N-Channel $V_{DS}=10\text{V}, V_{GS}=4.5\text{V},$ $I_{DS}=3\text{A}$	N-Ch	-	5	6.5	nC
			P-Ch	-	4	6	
Q_{gs}	Gate-Source Charge	P-Channel $V_{DS}=-10\text{V}, V_{GS}=-4.5\text{V},$ $I_{DS}=-1.5\text{A}$	N-Ch	-	0.5	-	
			P-Ch	-	0.6	-	
Q_{gd}	Gate-Drain Charge	N-Channel $V_{DS}=10\text{V}, V_{GS}=4.5\text{V},$ $I_{DS}=3\text{A}$	N-Ch	-	1.6	-	
			P-Ch	-	1	-	

Note a : Pulse test ; pulse width $\leq 300\mu\text{s}$, duty cycle $\leq 2\%$.

Note b : Guaranteed by design, not subject to production testing.

Typical Operating Characteristics

N-Channel

Power Dissipation

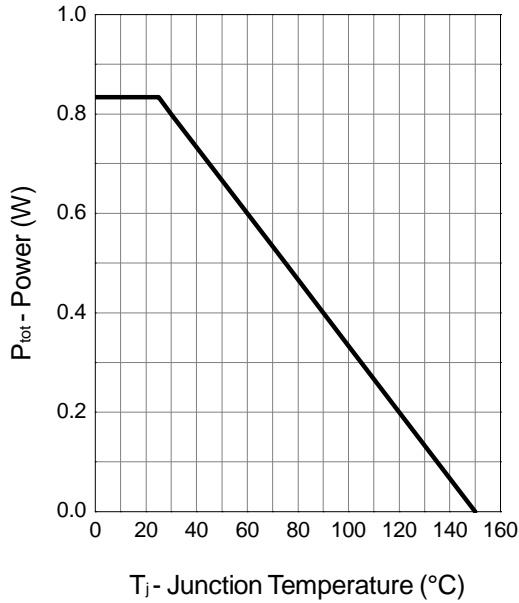

Drain Current

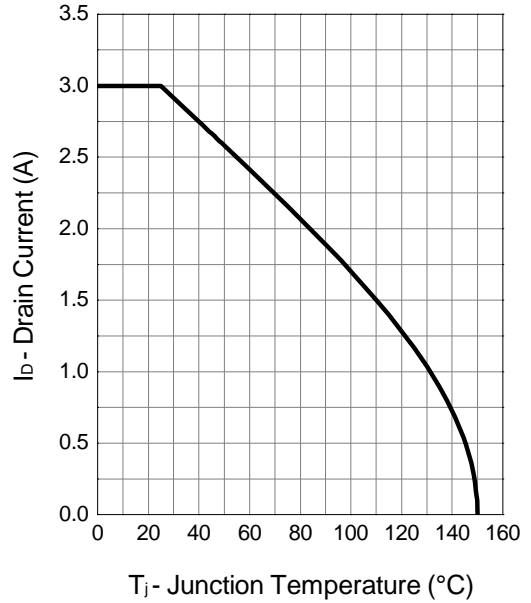

Safe Operation Area

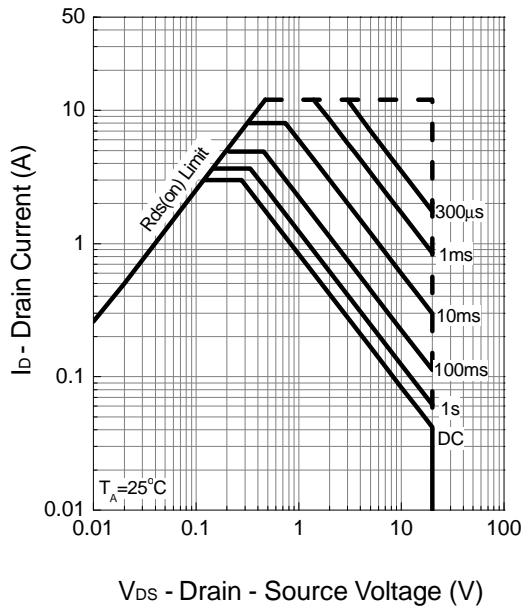

Thermal Transient Impedance

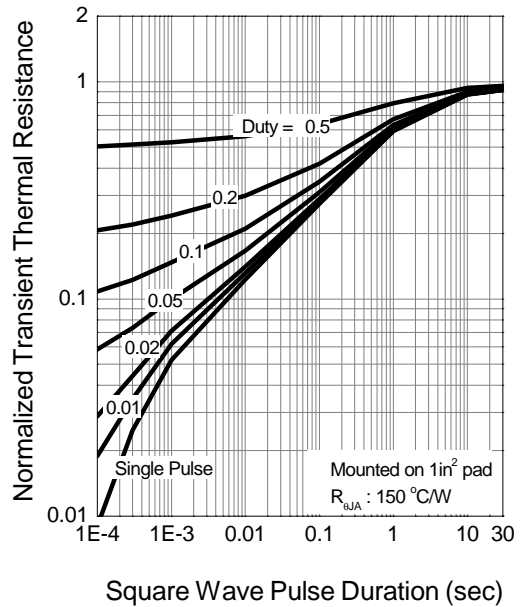

Typical Operating Characteristics (Cont.)

N-Channel

Output Characteristics

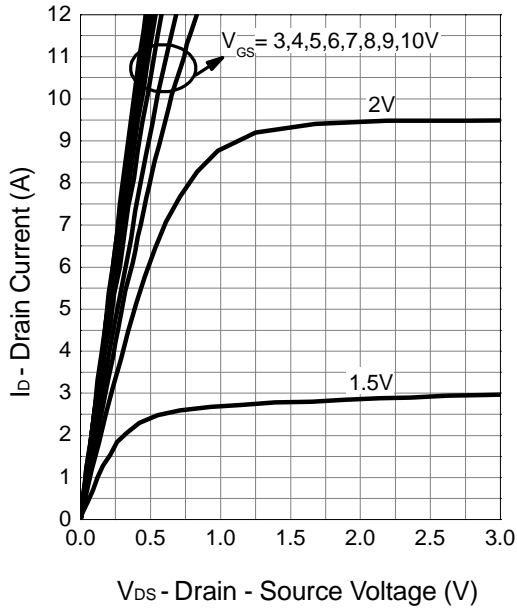

Drain-Source On Resistance

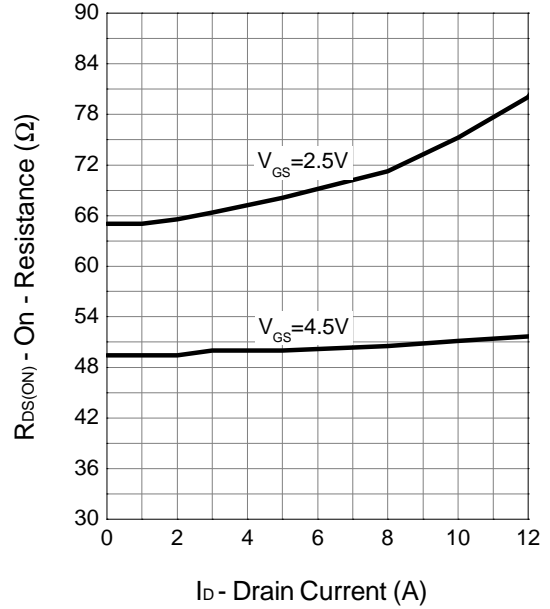

Gate-Source On Resistance

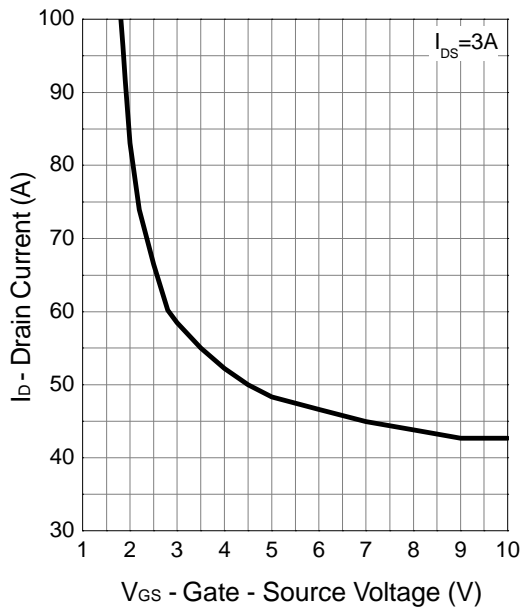

Gate Threshold Voltage

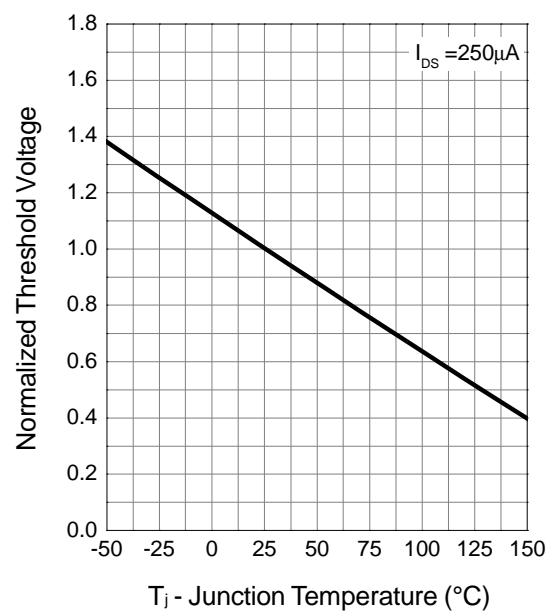

Typical Operating Characteristics (Cont.)

N-Channel

Drain-Source On Resistance

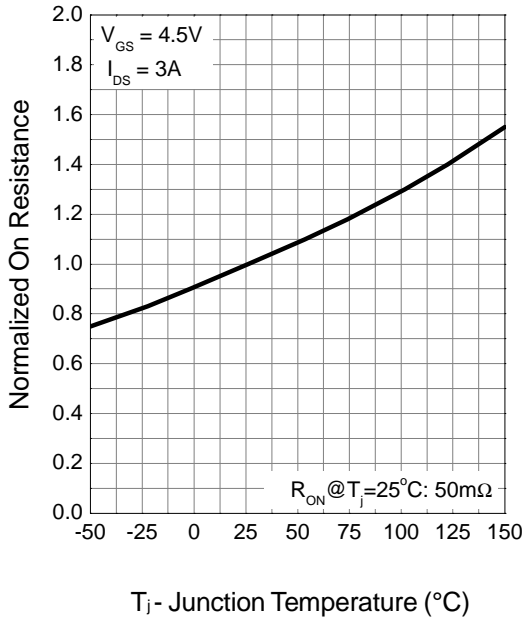

Source-Drain Diode Forward

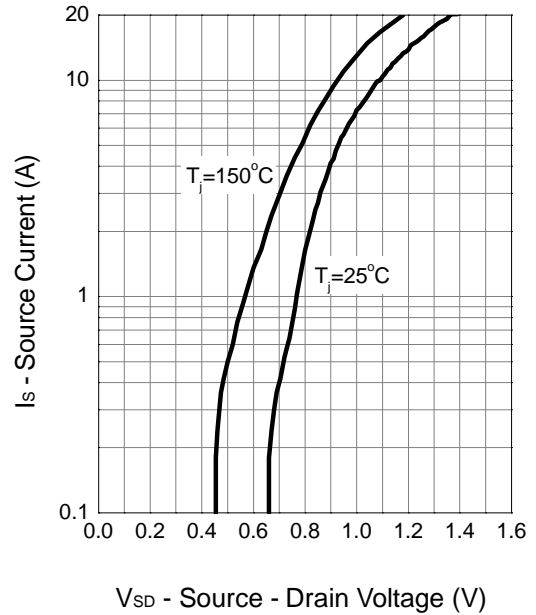

Capacitance

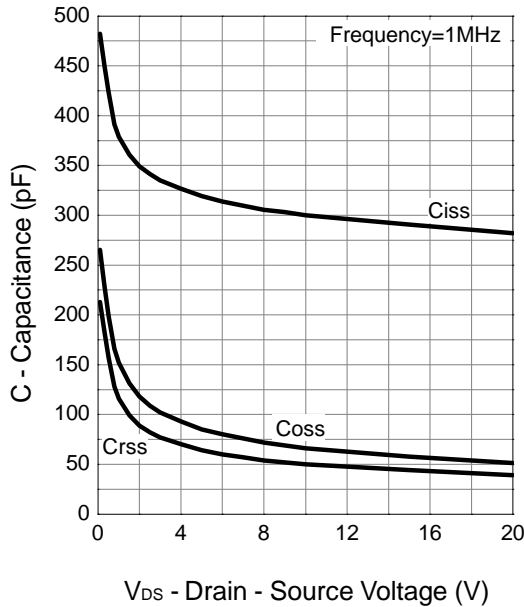

Gate Charge

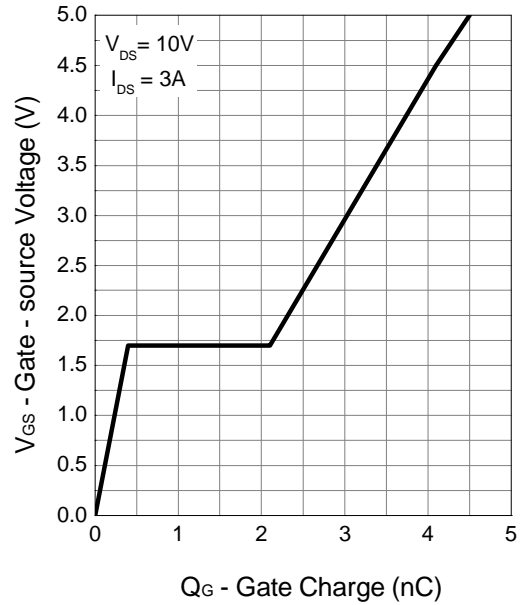

Typical Operating Characteristics (Cont.)

P-Channel

Power Dissipation

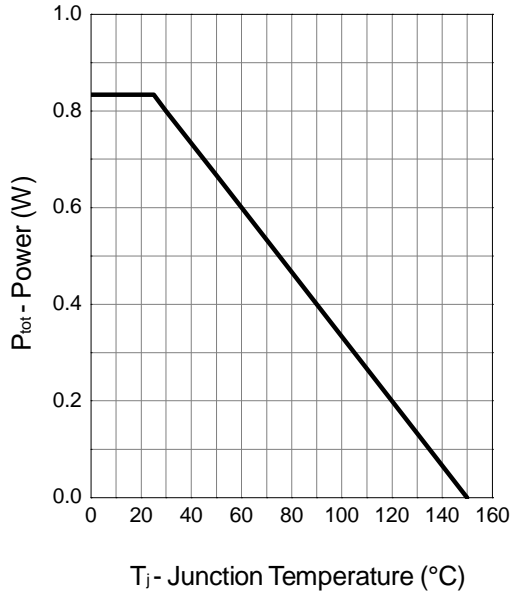

Drain Current

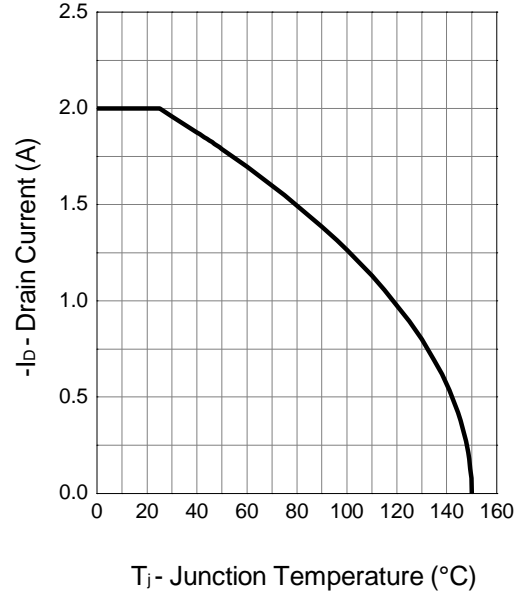

Safe Operation Area

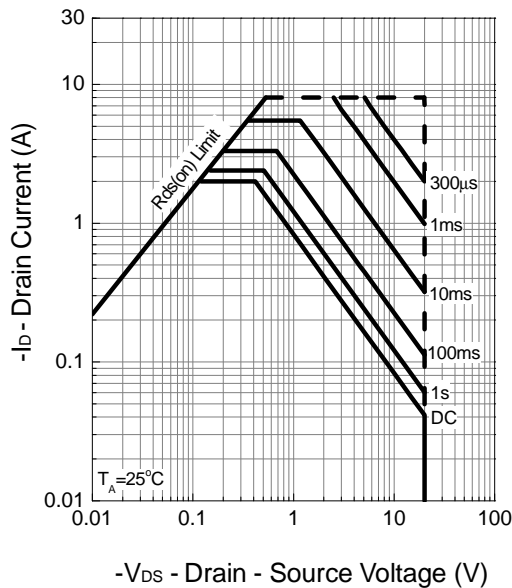

Thermal Transient Impedance

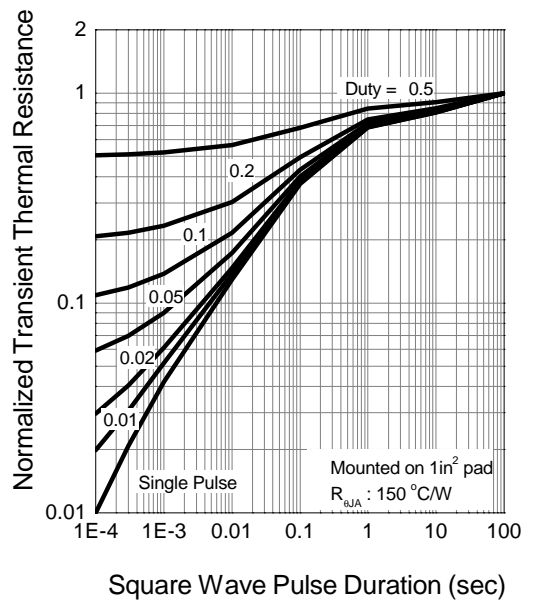

Typical Operating Characteristics (Cont.)

P-Channel

Output Characteristics

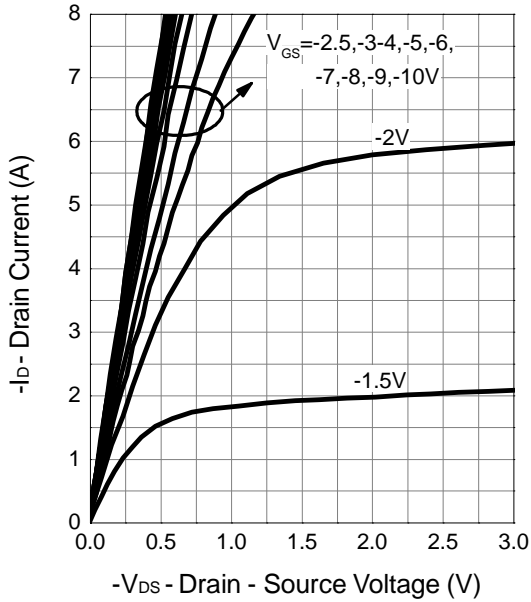

Drain-Source On Resistance

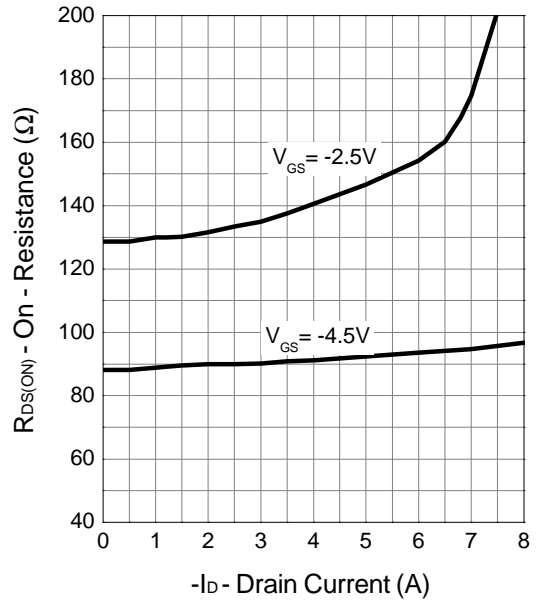

Gate-Source On Resistance

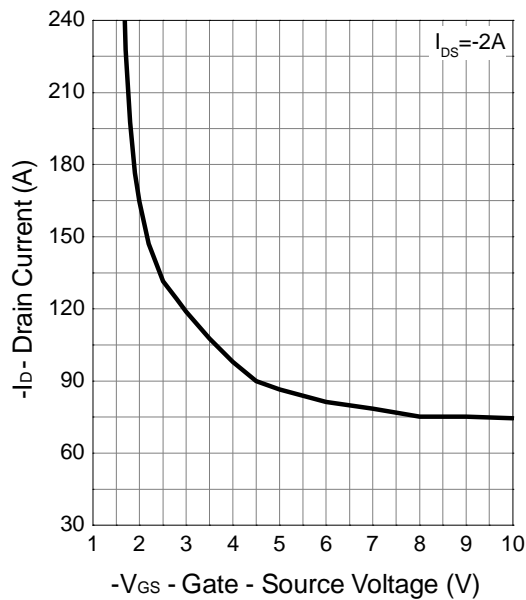

Gate Threshold Voltage

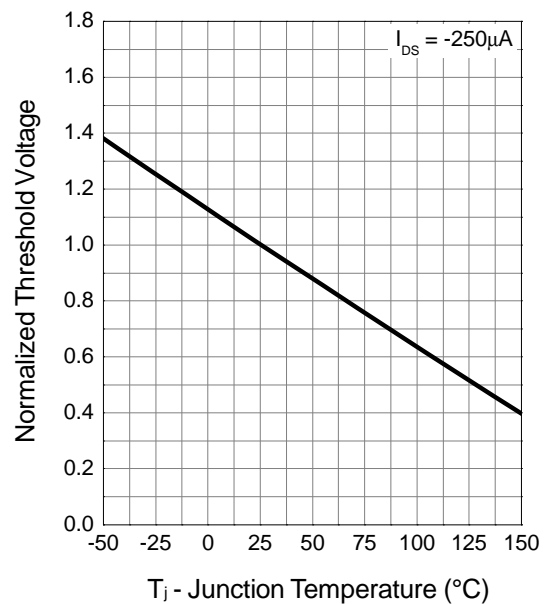

Typical Operating Characteristics (Cont.)

P-Channel

Drain-Source On Resistance

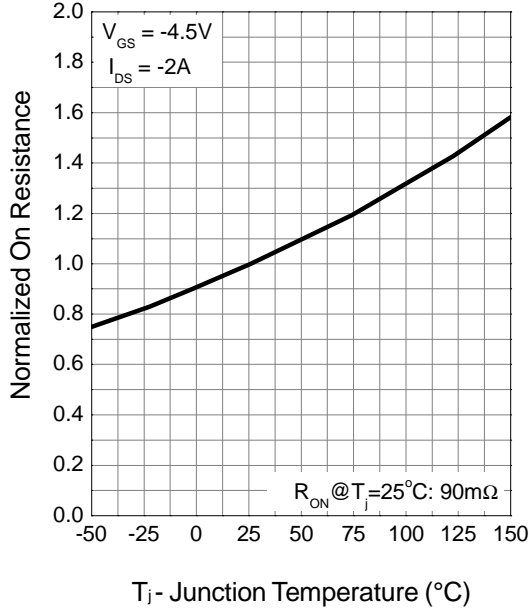

Source-Drain Diode Forward

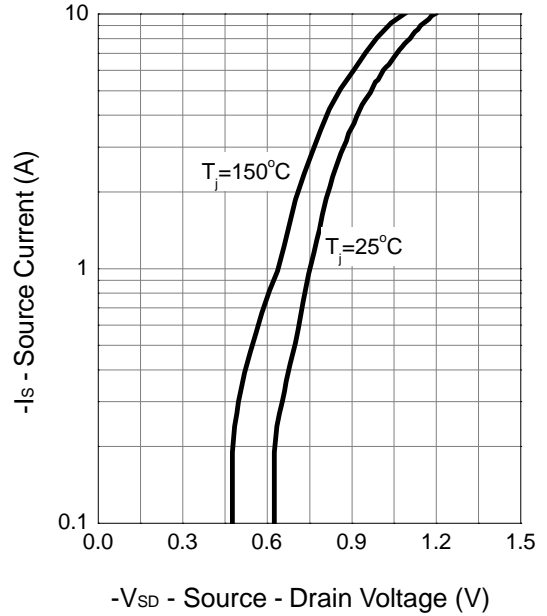

Capacitance

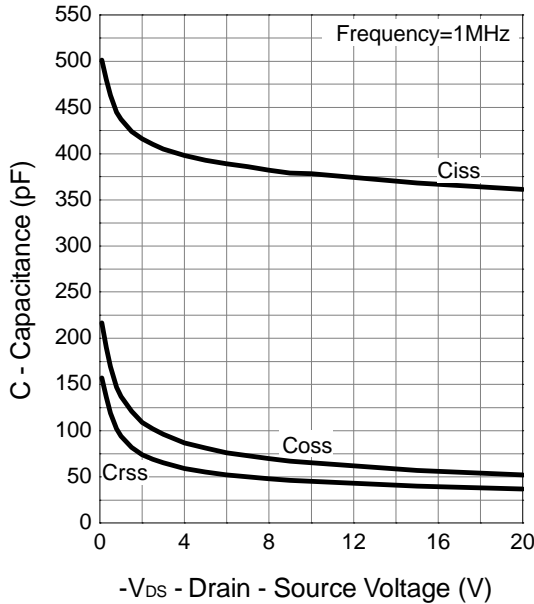

Gate Charge

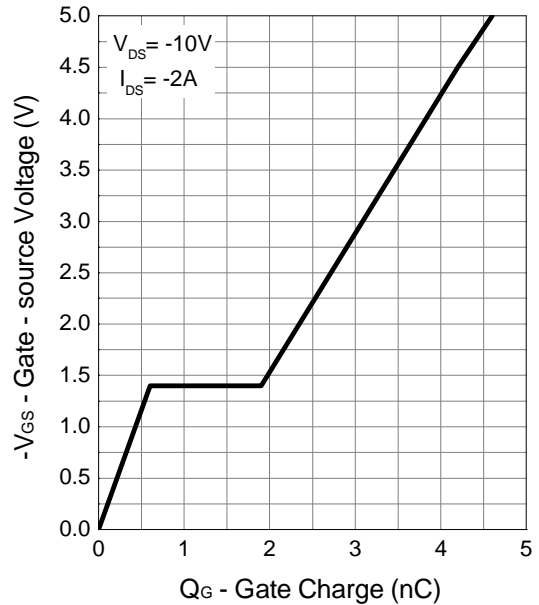

Package Information

JSOT-6

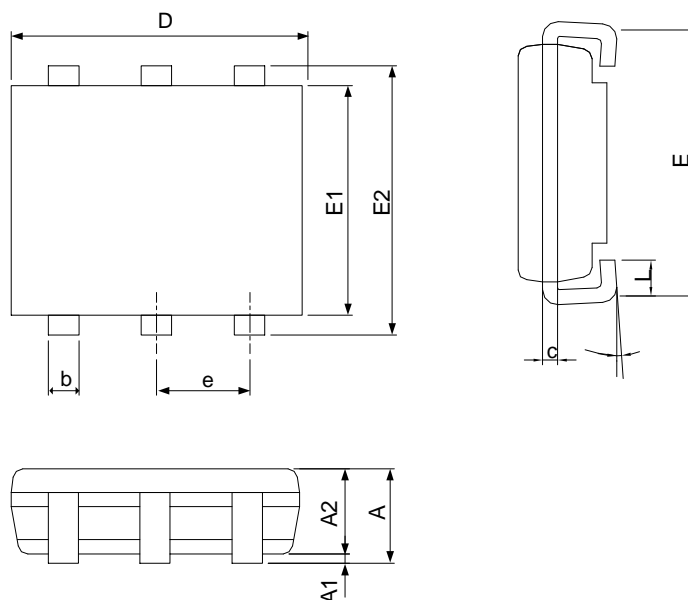

L O D E S	JSOT-6			
	MILLIMETERS		INCHES	
	MIN.	MAX.	MIN.	MAX.
A	0.93	1.10	0.037	0.043
A1	0.01	0.10	0.000	0.004
A2	0.92	1.00	0.036	0.039
b	0.25	0.40	0.010	0.016
c	0.10	0.20	0.004	0.008
D	2.95	3.10	0.116	0.122
E	2.50	3.00	0.098	0.118
E1	2.30	2.50	0.091	0.098
E2	2.65	3.05	0.104	0.120
e	0.95 BSC		0.037 BSC	
θ	0°	8°	0°	8°
L	0.30	0.60	0.012	0.024

Note : 1. Follow GEM 2928 6J.
 2. Dimension D, D1, and E1 do not include mold flash or protrusions. Mold flash or protrusions shall not exceed 10 mil.

Carrier Tape & Reel Dimensions

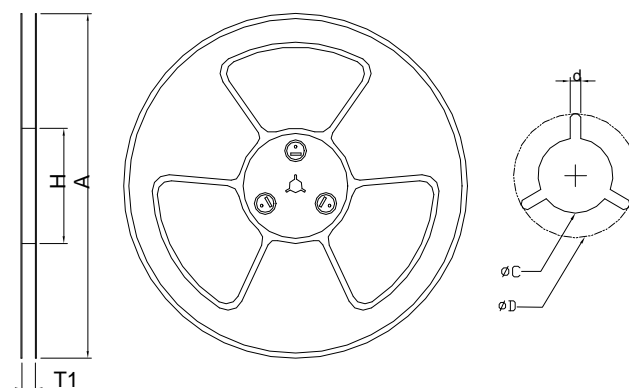
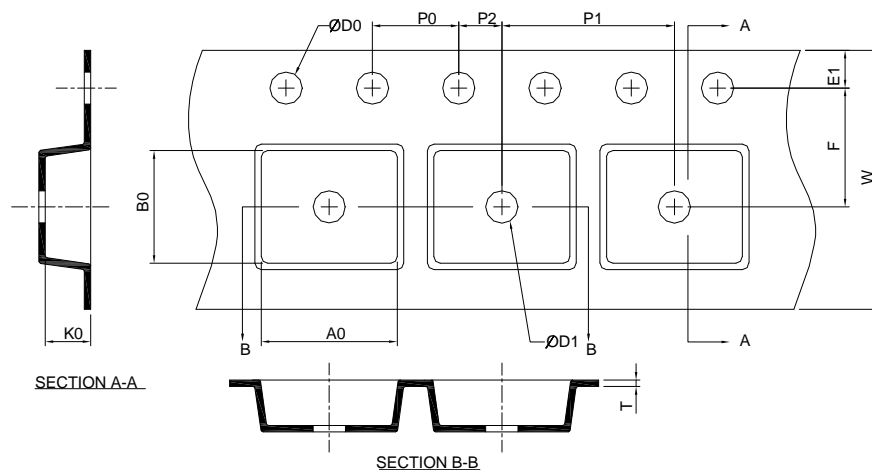

Application	A	H	T1	C	d	D	W	E1	F
JSOT-6	178.0 ±0.00	50 MIN.	8.4+2.00 -0.00	13.0+0.50 -0.20	1.5 MIN.	20.2 MIN.	8.0 ±0.30	1.75 ±0.10	3.5 ±0.05
	P0	P1	P2	D0	D1	T	A0	B0	K0
	4.0 ±0.10	4.0 ±0.10	2.0 ±0.05	1.5+0.10 -0.00	1.0 MIN.	0.6+0.00 -0.40	3.20 ±0.20	3.10 ±0.20	1.50 ±0.20

(mm)

Devices Per Unit

Package Type	Unit	Quantity
JSOT-6	Tape & Reel	3000

Taping Direction Information

JSOT-6

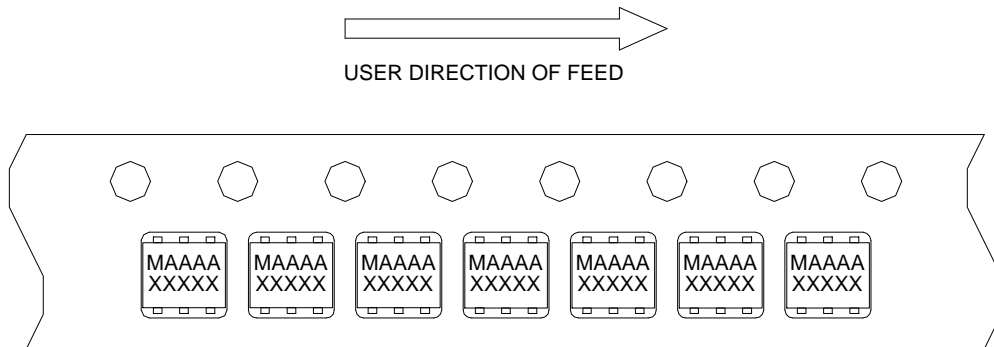

Classification Profile

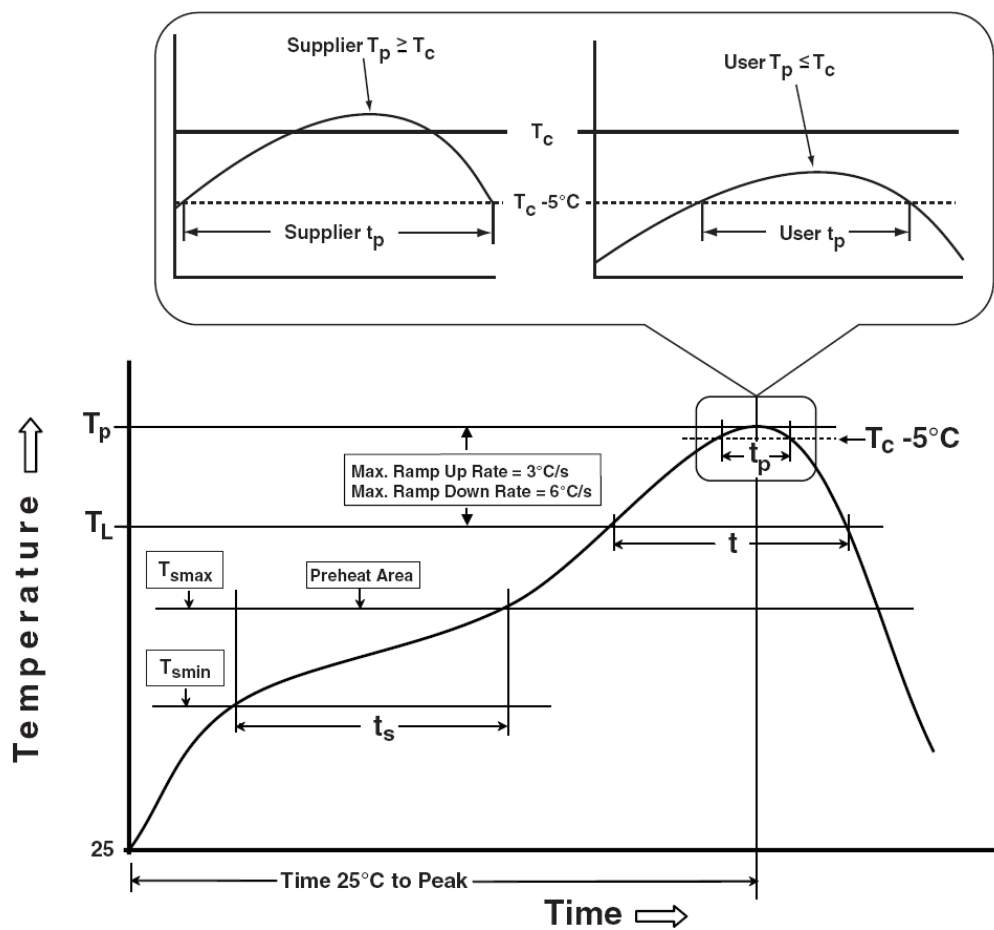

Classification Reflow Profiles

Profile Feature	Sn-Pb Eutectic Assembly	Pb-Free Assembly
Preheat & Soak		
Temperature min (T_{smin})	100 °C	150 °C
Temperature max (T_{smax})	150 °C	200 °C
Time (T_{smin} to T_{smax}) (t_s)	60-120 seconds	60-120 seconds
Average ramp-up rate (T_{smax} to T_p)	3 °C/second max.	3°C/second max.
Liquidous temperature (T_L)	183 °C	217 °C
Time at liquidous (t_L)	60-150 seconds	60-150 seconds
Peak package body Temperature (T_p)*	See Classification Temp in table 1	See Classification Temp in table 2
Time (t_p)** within 5°C of the specified classification temperature (T_c)	20** seconds	30** seconds
Average ramp-down rate (T_p to T_{smax})	6 °C/second max.	6 °C/second max.
Time 25°C to peak temperature	6 minutes max.	8 minutes max.
* Tolerance for peak profile Temperature (T_p) is defined as a supplier minimum and a user maximum.		
** Tolerance for time at peak profile temperature (t_p) is defined as a supplier minimum and a user maximum.		

Table 1. SnPb Eutectic Process – Classification Temperatures (T_c)

Package Thickness	Volume mm ³ <350	Volume mm ³ ≥350
<2.5 mm	235 °C	220 °C
≥2.5 mm	220 °C	220 °C

Table 2. Pb-free Process – Classification Temperatures (T_c)

Package Thickness	Volume mm ³ <350	Volume mm ³ 350-2000	Volume mm ³ >2000
<1.6 mm	260 °C	260 °C	260 °C
1.6 mm – 2.5 mm	260 °C	250 °C	245 °C
≥2.5 mm	250 °C	245 °C	245 °C

Reliability Test Program

Test item	Method	Description
SOLDERABILITY	JESD-22, B102	5 Sec, 245°C
HOLT	JESD-22, A108	1000 Hrs, Bias @ 125°C
PCT	JESD-22, A102	168 Hrs, 100%RH, 2atm, 121°C
TCT	JESD-22, A104	500 Cycles, -65°C~150°C

Customer Service

Anpec Electronics Corp.

Head Office :

No.6, Dusing 1st Road, SBIP,
Hsin-Chu, Taiwan, R.O.C.

Tel : 886-3-5642000

Fax : 886-3-5642050

Taipei Branch :

2F, No. 11, Lane 218, Sec 2 Jhongsing Rd.,
Sindain City, Taipei County 23146, Taiwan

Tel : 886-2-2910-3838

Fax : 886-2-2917-3838