

PRELIMINARY SPEC

KPBD-3224PBVGKC

BLUE / GREEN

Features

- 3.2x2.4mm SMT LED, 2.4mm THICKNESS.
- LOW POWER CONSUMPTION.
- IDEAL FOR BACKLIGHT AND INDICATOR.
- VARIOUS COLORS AND LENS TYPES AVAILABLE.
- PACKAGE : 1500PCS / REEL.

Description

The Blue source color devices are made with InGaN on SiC Light Emitting Diode.

The Green source color devices are made with DH InGaN on GaAs substrate Light Emitting Diode.

Package Dimensions

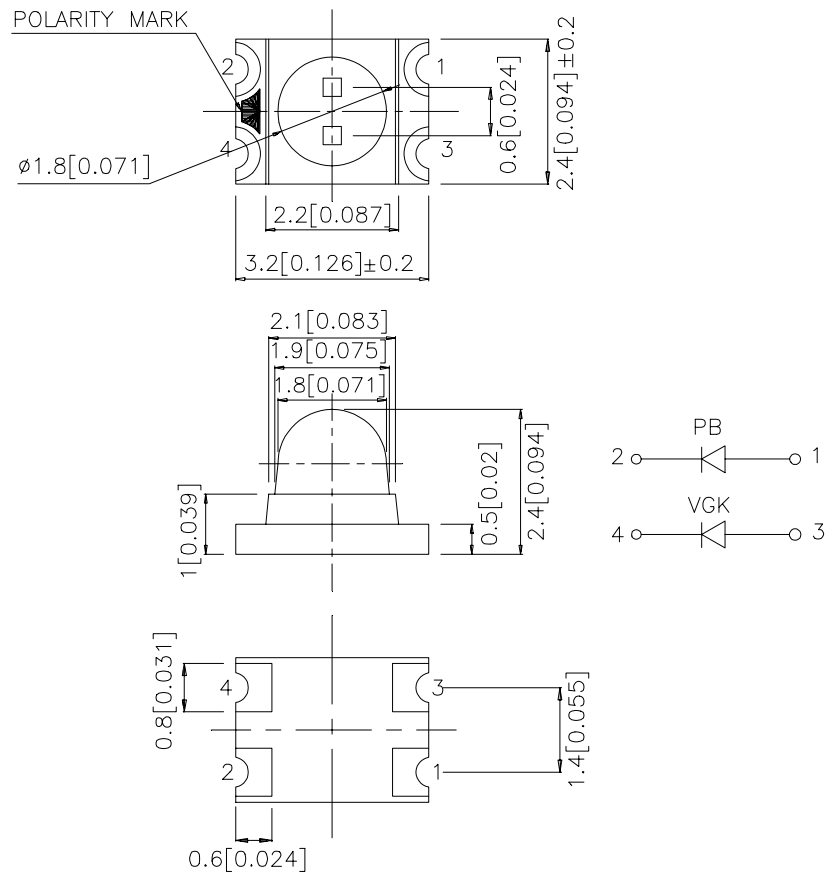

Notes:

1. All dimensions are in millimeters (inches).
2. Tolerance is $\pm 0.1(0.004")$ unless otherwise noted.
3. Specifications are subject to change without notice.

Selection Guide

Part No.	Dice	Lens Type	Iv (mcd) @ 20 mA		Viewing Angle
			Min.	Typ.	2θ1/2
KPBD-3224PBGK	BLUE (InGaN)	WATER CLEAR	36	100	20°
	GREEN (InGaN)		50	200	

Note:

1. θ1/2 is the angle from optical centerline where the luminous intensity is 1/2 the optical centerline value.

Absolute Maximum Ratings at T_A=25°C

Symbol	Parameter	Device	Typ.	Max.	Units	Test Conditions
λ _{peak}	Peak Wavelength	Blue Green	468 515		nm	I _F =20mA
λ _D	Dominant Wavelength	Blue Green	470 525		nm	I _F =20mA
Δλ _{1/2}	Spectral Line Half-width	Blue Green	25 30		nm	I _F =20mA
C	Capacitance	Blue Green	65 45		pF	V _F =0V;f=1MHz
V _F	Forward Voltage	Blue Green	3.65 4.2	4.2 4.8	V	I _F =20mA
I _R	Reverse Current	All		10	μA	V _R = 5V

Absolute Maximum Ratings at T_A=25°C

Parameter	Blue	Green	Units
Power dissipation	102	105	mW
DC Forward Current	30	25	mA
Peak Forward Current [1]	160	130	mA
Reverse Voltage	5	5	V
Operating / Storage Temperature	-40°C To +85°C		

Note:

1. 1/10 Duty Cycle, 0.1ms Pulse Width.

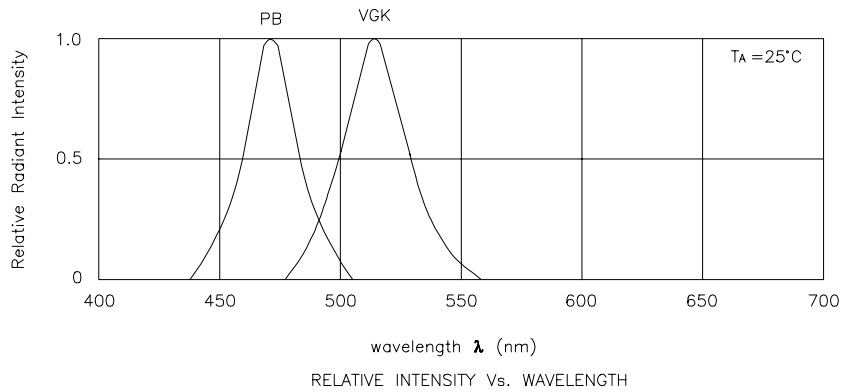

KPBD-3224PBVGKC

Blue

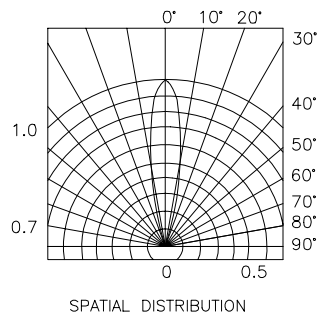
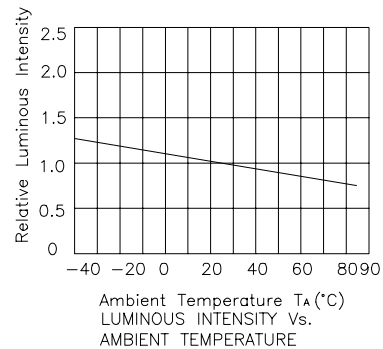
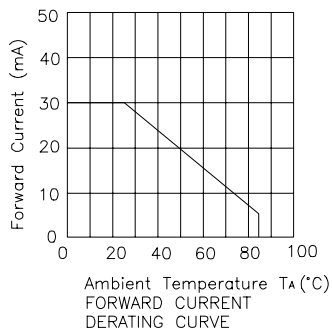
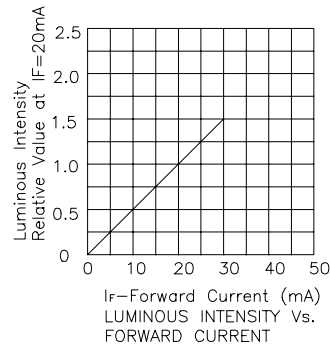
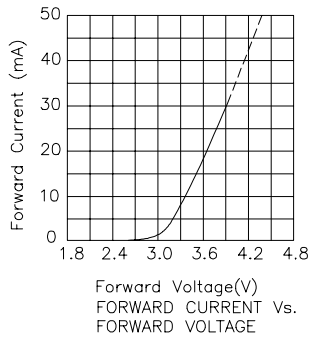

Green

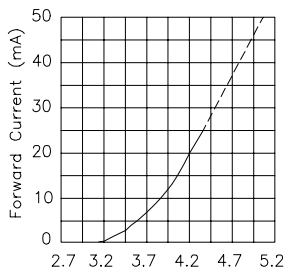

Forward Voltage(V)
FORWARD CURRENT Vs.
FORWARD VOLTAGE

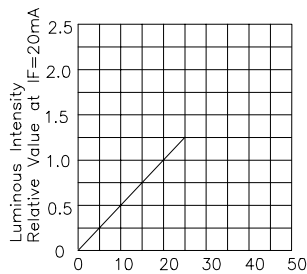

If-Forward Current (mA)
LUMINOUS INTENSITY Vs.
FORWARD CURRENT

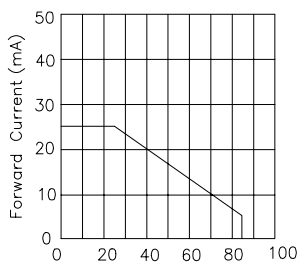

Ambient Temperature Ta (°C)
FORWARD CURRENT
DERATING CURVE

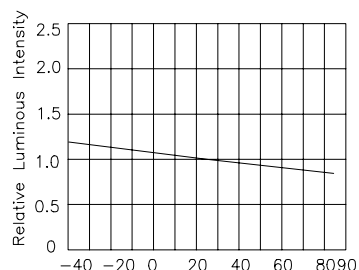

Ambient Temperature Ta (°C)
LUMINOUS INTENSITY Vs.
AMBIENT TEMPERATURE

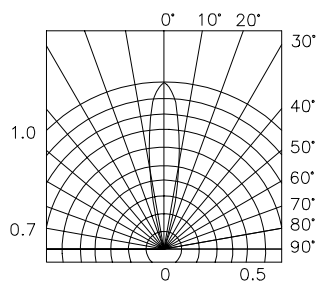

SPATIAL DISTRIBUTION

KPBD-3224PBVGKC SMT Reflow Soldering Instructions

Number of reflow process shall be less than 2 times and cooling process to normal temperature is required between first and second soldering process.

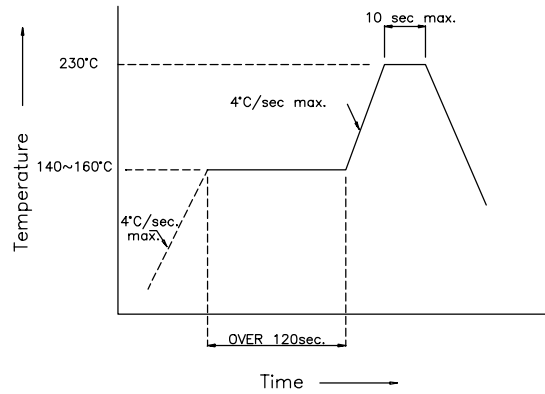

Recommended Soldering Pattern (Units : mm)

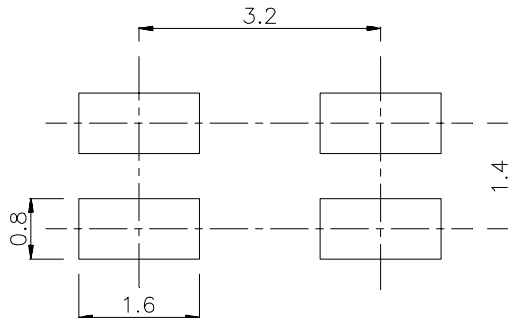

Tape Specifications (Units : mm)

