

FEATURES

- Operation from 400 MHz to 4000 MHz
- Gain of 14.6 dB at 2140 MHz
- OIP3 of 43.1 dBm at 2140 MHz
- P1dB of 29.1 dBm at 2140 MHz
- Noise figure of 3.8 dB
- Dynamically adjustable bias
 - Adjustable power supply bias: 3.3 V to 5 V
 - Low power supply current: 62 mA to 133 mA
 - No bias resistor needed
- Operating temperature range of -40°C to $+105^{\circ}\text{C}$
- SOT-89 package, MSL-1 rated
- ESD rating of ± 3 kV (Class 2)

APPLICATIONS

- Wireless infrastructure
- Automated test equipment
- ISM/AMR applications

GENERAL DESCRIPTION

The **ADL5324** incorporates a dynamically adjustable biasing circuit that allows for the customization of OIP3 and P1dB performance from 3.3 V to 5 V, without the need for an external bias resistor. This feature gives the designer the ability to tailor driver amplifier performance to the specific needs of the design. This feature also creates the opportunity for dynamic biasing of the driver amplifier where a variable supply is used to allow for full 5 V biasing under large signal conditions, and then reduced supply voltage when signal levels are smaller and lower power consumption is desirable. This scalability reduces the need to evaluate and inventory multiple driver amplifiers for different output power requirements, from 25 dBm to 29 dBm output power levels.

The **ADL5324** is also rated to operate across the wide temperature range of -40°C to $+105^{\circ}\text{C}$ for reliable performance in designs that experience higher temperatures, such as power amplifiers. The ½ W driver amplifier also covers the wide frequency range of 400 MHz to 4000 MHz, and only requires a few external components to be tuned to a specific band within that wide range. This high performance broadband RF driver amplifier is well suited for a variety of wired and wireless applications, including cellular infrastructure, ISM band power amplifiers, defense equipment, and instrumentation equipment. A fully populated evaluation board is available.

FUNCTIONAL BLOCK DIAGRAM

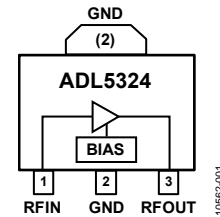

Figure 1.

The **ADL5324** also delivers excellent ACPR vs. output power and bias voltage. The driver can deliver greater than 17 dBm of output power at 2140 MHz, while achieving an ACPR of -55 dBc at 5 V. If the bias is reduced to 3.3 V, the -55 dBc ACPR output power only minimally reduces to 15 dBm.

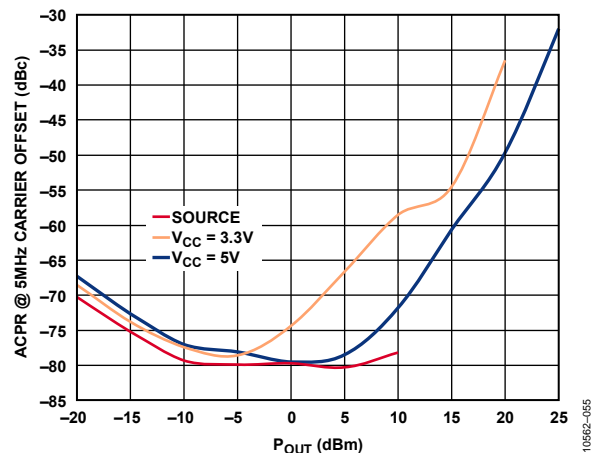

Figure 2. ACPR vs. Output Power, Single Carrier W-CDMA, TM1-64 at 2140 MHz

Rev. 0

Information furnished by Analog Devices is believed to be accurate and reliable. However, no responsibility is assumed by Analog Devices for its use, nor for any infringements of patents or other rights of third parties that may result from its use. Specifications subject to change without notice. No license is granted by implication or otherwise under any patent or patent rights of Analog Devices. Trademarks and registered trademarks are the property of their respective owners.

TABLE OF CONTENTS

Features	1	High Temperature Operation	12
Applications.....	1	Applications Information	13
Functional Block Diagram	1	Basic Layout Connections.....	13
General Description	1	Soldering Information and Recommended PCB Land Pattern.....	13
Revision History	2	Matching Procedure.....	15
Specifications.....	3	W-CDMA ACPR Performance	16
Typical Scattering Parameters.....	5	Evaluation Board	17
Absolute Maximum Ratings.....	6	Outline Dimensions	20
ESD Caution.....	6	Ordering Guide	20
Pin Configuration and Function Descriptions.....	7		
Typical Performance Characteristics	8		

REVISION HISTORY

3/12—Revision 0: Initial Version

SPECIFICATIONS

VSUP = 5 V and T_A = 25°C, unless otherwise noted.

Table 1.

Parameter	Test Conditions/Comments	3.3 V			5 V			Unit
		Min	Typ	Max	Min	Typ	Max	
FREQUENCY = 457 MHz								
Gain			17.2			18.4		dB
vs. Frequency	±37 MHz		+0.0/−0.4			+0.0/−0.2		dB
vs. Temperature	−40°C ≤ T _A ≤ +85°C		±0.6			±0.6		dB
vs. Supply	3.15 V to 3.45 V, 4.75 V to 5.25 V		±0.3			±0.07		dB
Output 1 dB Compression Point			24.2			28.0		dBm
Output Third-Order Intercept	Δf = 1 MHz, P _{OUT} = 10 dBm per tone		30.1			40.1		dBm
Noise Figure			5.6			6.8		dB
FREQUENCY = 748 MHz								
Gain			16.5			17.5		dB
vs. Frequency	±20 MHz		+0.0/−0.2			+0.0/−0.2		dB
vs. Temperature	−40°C ≤ T _A ≤ +85°C		±0.4			±0.4		dB
vs. Supply	3.15 V to 3.45 V, 4.75 V to 5.25 V		±0.2			±0.06		dB
Output 1 dB Compression Point			24.2			28.0		dBm
Output Third-Order Intercept	Δf = 1 MHz, P _{OUT} = 10 dBm per tone		36.0			45.8		dBm
Noise Figure			4.0			5.2		dB
FREQUENCY = 915 MHz								
Gain ¹			15.8		16.0	16.8	17.6	dB
vs. Frequency	±46 MHz		±0.1			+0.1/−0.3		dB
vs. Temperature	−40°C ≤ T _A ≤ +85°C		±0.4			±0.4		dB
vs. Supply	3.15 V to 3.45 V, 4.75 V to 5.25 V		±0.2			±0.06		dB
Output 1 dB Compression Point			24.2			27.7		dBm
Output Third-Order Intercept	Δf = 1 MHz, P _{OUT} = 10 dBm per tone		39.3			45.6		dBm
Noise Figure			4.1			5.1		dB
FREQUENCY = 1935 MHz								
Gain			13.9			15.0		dB
vs. Frequency	±55 MHz		+0.0/−0.1			+0.0/−0.1		dB
vs. Temperature	−40°C ≤ T _A ≤ +85°C		±0.5			±0.5		dB
vs. Supply	3.15 V to 3.45 V, 4.75 V to 5.25 V		±0.2			±0.07		dB
Output 1 dB Compression Point			23.2			27.2		dBm
Output Third-Order Intercept	Δf = 1 MHz, P _{OUT} = 10 dBm per tone		34.6			45.5		dBm
Noise Figure			3.1			3.6		dB
FREQUENCY = 2140 MHz								
Gain ¹			13.6		13.5	14.6	15.7	dB
vs. Frequency	±30 MHz		+0.1/−0.0			±0.1		dB
vs. Temperature	−40°C ≤ T _A ≤ +85°C		±0.6			±0.6		dB
vs. Supply	3.15 V to 3.45 V, 4.75 V to 5.25 V		±0.2			±0.06		dB
Output 1 dB Compression Point			25.3			29.1		dBm
Output Third-Order Intercept	Δf = 1 MHz, P _{OUT} = 10 dBm per tone		34.4			43.1		dBm
Noise Figure			3.2			3.8		dB

Parameter	Test Conditions/Comments	3.3 V			5 V			Unit
		Min	Typ	Max	Min	Typ	Max	
FREQUENCY = 2630 MHz								
Gain ¹			12.1		11.8	13.3	14.6	dB
vs. Frequency	±60 MHz		±0.1			+0.0/−0.2		dB
vs. Temperature	−40°C ≤ T _A ≤ +85°C		±0.7			±0.7		dB
vs. Supply	3.15 V to 3.45 V, 4.75 V to 5.25 V		±0.2			±0.07		dB
Output 1 dB Compression Point			23.6			27.8		dBm
Output Third-Order Intercept	Δf = 1 MHz, P _{OUT} = 10 dBm per tone		32.4			42.0		dBm
Noise Figure			3.6			4.3		dB
FREQUENCY = 3600 MHz								
Gain			11.0			12.0		dB
vs. Frequency	±100 MHz		+0.0/−0.7			+0.0/−0.8		dB
vs. Temperature	−40°C ≤ T _A ≤ +85°C		±1.0			±1.0		dB
vs. Supply	3.15 V to 3.45 V, 4.75 V to 5.25 V		±0.2			±0.05		dB
Output 1 dB Compression Point			25.0			28.5		dBm
Output Third-Order Intercept	Δf = 1 MHz, P _{OUT} = 10 dBm per tone		29.3			36.6		dBm
Noise Figure			3.8			4.4		dB
POWER INTERFACE								
Supply Voltage	Pin RFOUT	3.15	3.3	3.45	4.75	5	5.25	V
Supply Current			62			140		mA
vs. Temperature	−40°C ≤ T _A ≤ +85°C		+4/−6			+5/−7		mA
Power Dissipation	VSUP = 5 V		205			700		mW

¹ Guaranteed maximum and minimum specified limits on this parameter are based on six sigma calculations.

TYPICAL SCATTERING PARAMETERS

VSUP = 5 V and T_A = 25°C; the effects of the test fixture have been de-embedded up to the pins of the device.

Table 2.

Freq (MHz)	S11		S21		S12		S22	
	Magnitude (dB)	Angle (°)	Magnitude (dB)	Angle (°)	Magnitude (dB)	Angle (°)	Magnitude (dB)	Angle (°)
400	-0.73518	-178.582	13.3917	135.7023	-34.6804	12.40754	-3.04567	175.7277
500	-0.6682	178.6472	12.83594	125.9539	-34.2707	8.733014	-3.13245	175.9202
600	-0.69026	176.9348	12.14674	117.8626	-34.1019	6.416618	-3.13132	176.4634
700	-0.73622	175.8152	11.44082	111.0321	-34.0009	5.053048	-3.11375	177.3131
800	-0.78026	175.0847	10.7709	105.1552	-33.9042	3.90523	-3.08891	178.3368
900	-0.8238	174.5898	10.17296	99.91559	-33.7964	3.162531	-3.05337	179.4021
1000	-0.8703	174.2026	9.636511	95.21821	-33.6656	2.580227	-3.01719	-179.377
1100	-0.9211	173.9872	9.182607	91.01039	-33.5057	2.111382	-2.98741	-177.773
1200	-0.97114	173.3143	8.797653	86.68882	-33.3176	1.186726	-2.94972	-176.469
1300	-1.05332	172.9788	8.493785	82.89921	-33.0916	0.689198	-2.9749	-174.745
1400	-1.13807	172.418	8.268673	79.01047	-32.8261	-0.26086	-2.99624	-173.189
1500	-1.23342	171.5538	8.117951	74.96804	-32.5253	-1.43036	-3.02533	-171.783
1600	-1.34406	170.302	8.030017	70.69309	-32.1979	-3.08241	-3.04592	-170.675
1700	-1.47125	168.6736	7.998348	66.16438	-31.8306	-5.10232	-3.05748	-169.736
1800	-1.61396	166.5204	8.012977	61.23666	-31.4647	-7.75224	-3.08106	-169.23
1900	-1.78541	163.8113	8.0503	55.89288	-31.0967	-10.9203	-3.12034	-169.149
2000	-1.98158	160.6247	8.103461	50.12853	-30.7409	-14.671	-3.15588	-169.657
2100	-2.19535	157.0149	8.162658	43.95115	-30.4109	-19.0255	-3.18172	-170.862
2200	-2.43367	153.0489	8.207579	37.39437	-30.1134	-23.849	-3.19212	-172.621
2300	-2.68863	148.8413	8.231765	30.52801	-29.872	-29.1849	-3.17831	-174.879
2400	-2.95983	144.5491	8.231791	23.39294	-29.6822	-35.0026	-3.13204	-177.553
2500	-3.25472	140.354	8.199665	16.05117	-29.5353	-41.1796	-3.05541	179.4875
2600	-3.56594	136.4445	8.141897	8.510386	-29.4496	-47.7908	-2.94631	176.2481
2700	-3.90734	133.0736	8.052657	0.787456	-29.4307	-54.7743	-2.79325	172.8794
2800	-4.28173	130.4779	7.925075	-7.06584	-29.451	-62.1914	-2.57604	169.6831
2900	-4.69306	128.952	7.778394	-15.0835	-29.5362	-69.9289	-2.31023	166.7304
3000	-5.13012	128.7774	7.590076	-23.2924	-29.673	-78.1809	-2.00734	164.1571
3100	-5.54712	130.3019	7.355608	-31.6367	-29.8658	-86.8436	-1.69231	162.0214
3200	-5.86482	133.6487	7.062082	-40.2413	-30.1507	-96.2073	-1.37649	160.0906
3300	-5.98131	138.5443	6.680613	-48.9518	-30.5191	-106.08	-1.0663	158.4485
3400	-5.80159	144.0974	6.20792	-57.556	-30.9857	-116.217	-0.80053	157.172
3500	-5.34159	149.2672	5.63213	-65.9828	-31.5373	-126.686	-0.58238	156.1642
3600	-4.7127	153.2749	4.988874	-73.9355	-32.1461	-137.413	-0.41604	155.491
3700	-4.03208	155.8906	4.279792	-81.4065	-32.7942	-148.125	-0.30331	155.1641
3800	-3.37391	157.3335	3.543499	-88.1911	-33.4212	-158.775	-0.23714	155.0734
3900	-2.79798	157.8681	2.803935	-94.5028	-33.9833	-169.303	-0.20674	155.156
4000	-2.30194	157.7622	2.085365	-100.344	-34.3781	-179.983	-0.20598	155.3378

ABSOLUTE MAXIMUM RATINGS

Table 3.

Parameter	Rating
Supply Voltage, VSUP	6.5 V
Input Power (50 Ω Impedance)	20 dBm
Internal Power Dissipation (Paddle Soldered)	1.9 W
Maximum Junction Temperature	150°C
Operating Temperature Range	-40°C to +105°C
Storage Temperature Range	-65°C to +150°C

Stresses above those listed under Absolute Maximum Ratings may cause permanent damage to the device. This is a stress rating only; functional operation of the device at these or any other conditions above those indicated in the operational section of this specification is not implied. Exposure to absolute maximum rating conditions for extended periods may affect device reliability.

THERMAL RESISTANCE

Table 4 lists the junction-to-air thermal resistance (θ_{JA}) and the junction-to-paddle thermal resistance (θ_{JC}) for the [ADL5324](#).

Table 4. Thermal Resistance

Package Type	θ_{JA} ¹	θ_{JC} ²	Unit
3-Lead SOT-89	37	9	°C/W

¹Measured on Analog Devices evaluation board. For more information about board layout, see the Soldering Information and Recommended PCB Land Pattern section.

²Based on simulation with JEDEC standard JESD51.

ESD CAUTION



ESD (electrostatic discharge) sensitive device. Charged devices and circuit boards can discharge without detection. Although this product features patented or proprietary protection circuitry, damage may occur on devices subjected to high energy ESD. Therefore, proper ESD precautions should be taken to avoid performance degradation or loss of functionality.

PIN CONFIGURATION AND FUNCTION DESCRIPTIONS

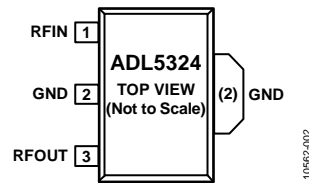

Figure 3. Pin Configuration

Table 5. Pin Function Descriptions

Pin No.	Mnemonic	Description
1	RFIN	RF Input. This pin requires a dc blocking capacitor.
2	GND	Ground. Connect this pin to a low impedance ground plane. Note that the paddle, which is exposed, encompasses Pin 2 and the tab at the top side of the package. It should be soldered to a low impedance ground plane for electrical grounding and thermal transfer.
3	RFOUT	RF Output and Supply Voltage. DC bias is provided to this pin through an inductor that is connected to the external power supply. The RF path requires a dc blocking capacitor.

TYPICAL PERFORMANCE CHARACTERISTICS

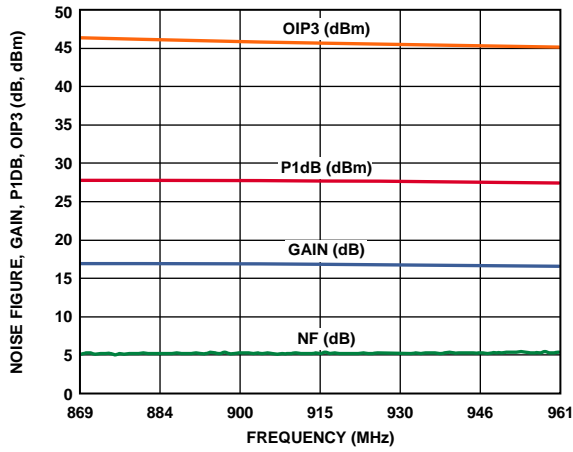

Figure 4. Gain, P1dB, OIP3, and Noise Figure vs. Frequency, 869 MHz to 961 MHz

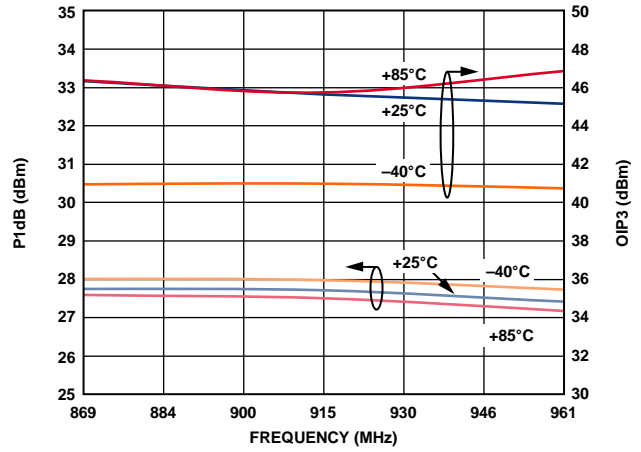

Figure 7. OIP3 and P1dB vs. Frequency and Temperature, 869 MHz to 961 MHz

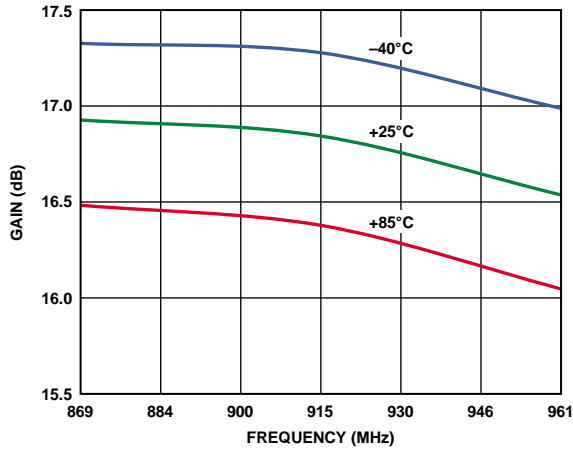

Figure 5. Gain vs. Frequency and Temperature, 869 MHz to 961 MHz

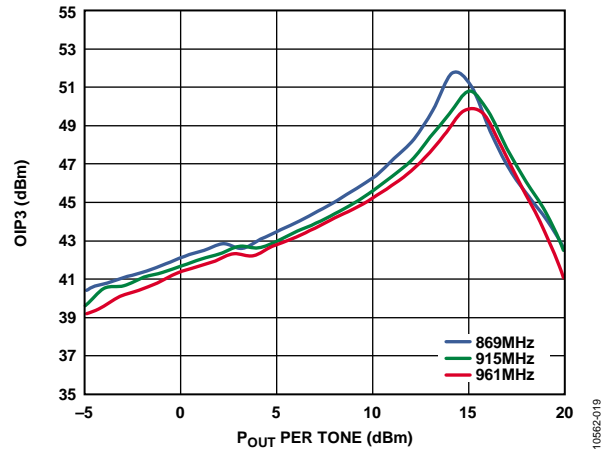

Figure 8. OIP3 vs. P_{OUT} and Frequency, 869 MHz to 961 MHz

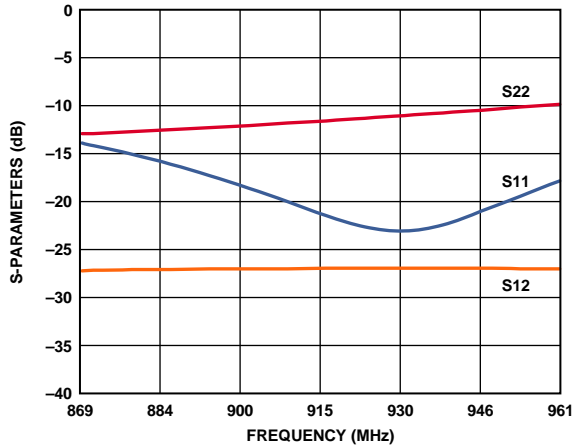

Figure 6. Input Return Loss (S11), Output Return Loss (S22), and Reverse Isolation (S12) vs. Frequency, 869 MHz to 961 MHz

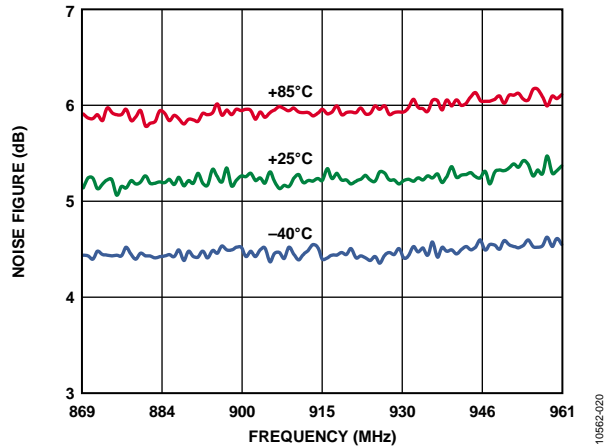

Figure 9. Noise Figure vs. Frequency and Temperature, 869 MHz to 961 MHz

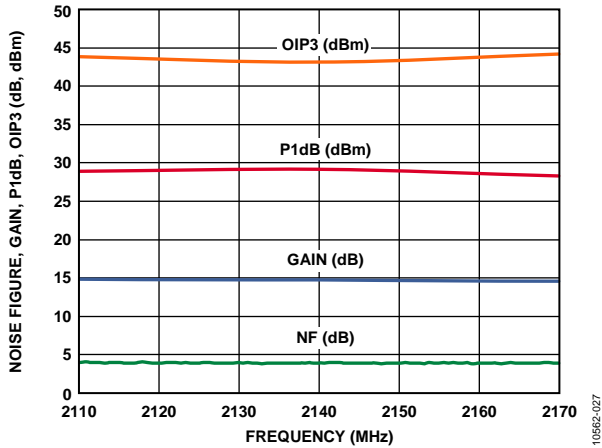

Figure 10. Gain, P1dB, OIP3, and Noise Figure vs. Frequency, 2110 MHz to 2170 MHz

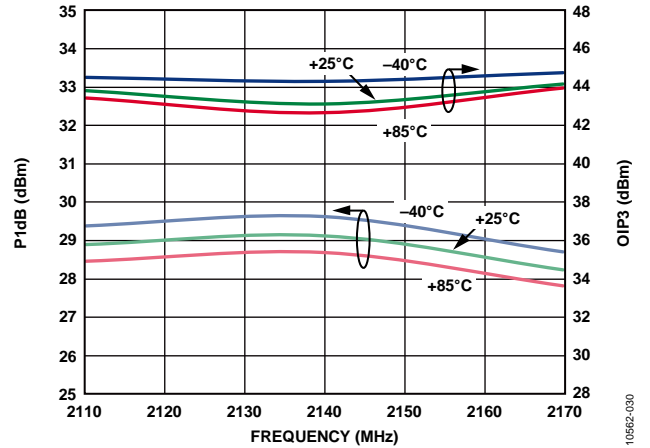

Figure 13. OIP3 and P1dB vs. Frequency and Temperature, 2110 MHz to 2170 MHz

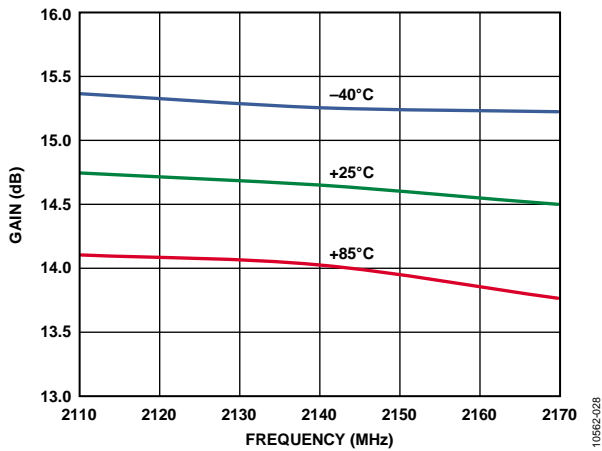

Figure 11. Gain vs. Frequency and Temperature, 2110 MHz to 2170 MHz

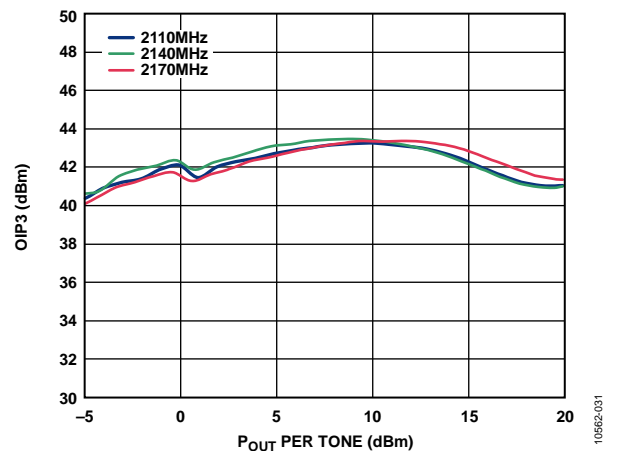

Figure 14. OIP3 vs. P_{OUT} and Frequency, 2110 MHz to 2170 MHz

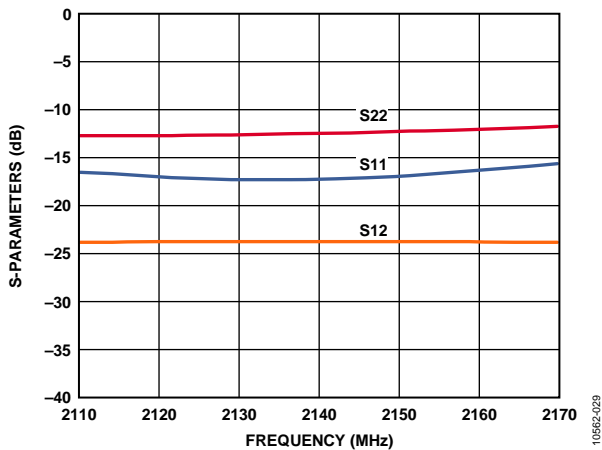

Figure 12. Input Return Loss (S11), Output Return Loss (S22), and Reverse Isolation (S12) vs. Frequency, 2110 MHz to 2170 MHz

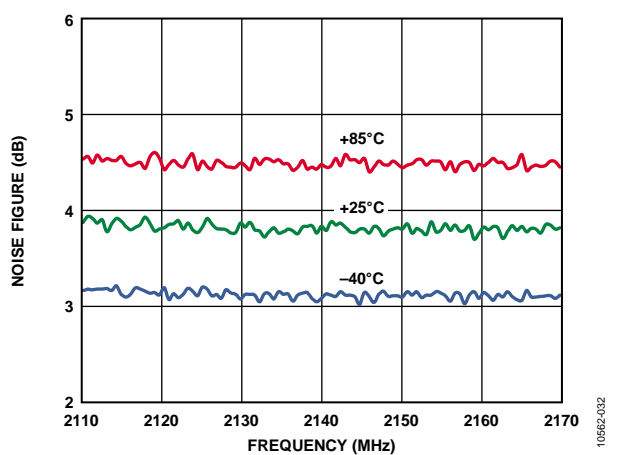

Figure 15. Noise Figure vs. Frequency and Temperature, 2110 MHz to 2170 MHz

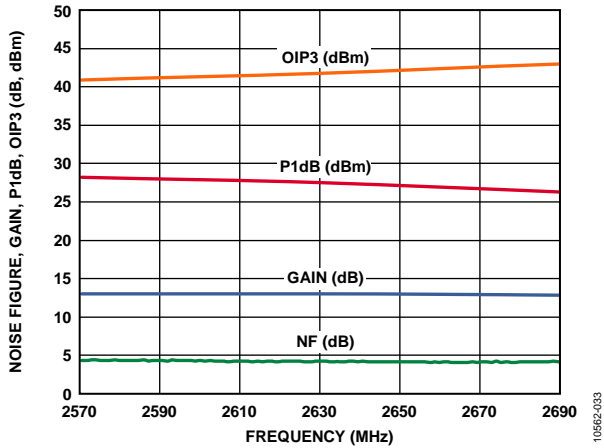

Figure 16. Gain, P1dB, OIP3, and Noise Figure vs. Frequency, 2570 MHz to 2690 MHz

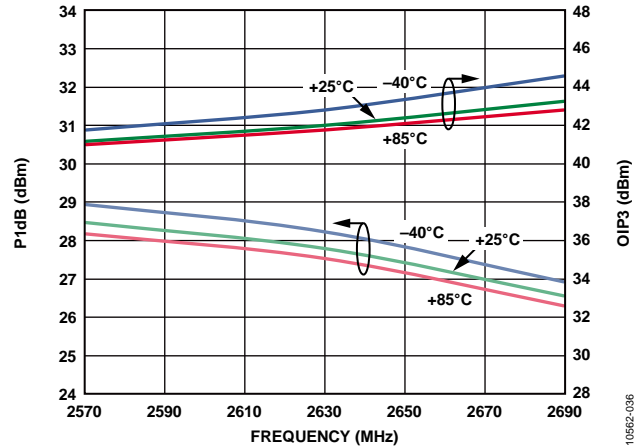

Figure 19. OIP3 and P1dB vs. Frequency and Temperature, 2570 MHz to 2690 MHz

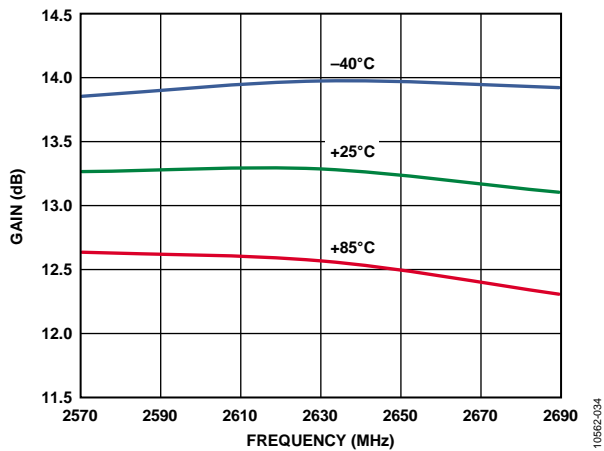

Figure 17. Gain vs. Frequency and Temperature, 2570 MHz to 2690 MHz

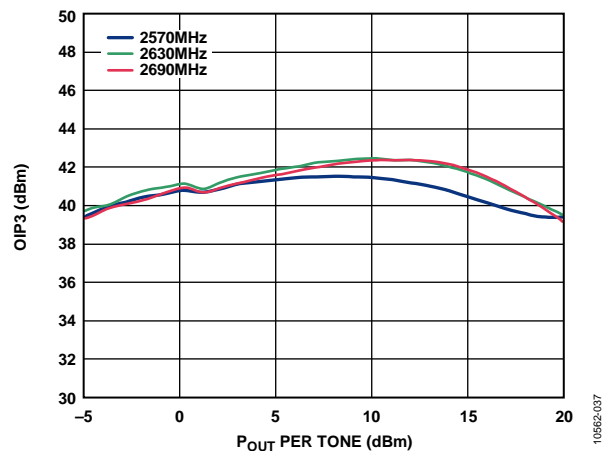

Figure 20. OIP3 vs. P_{OUT} and Frequency, 2570 MHz to 2690 MHz

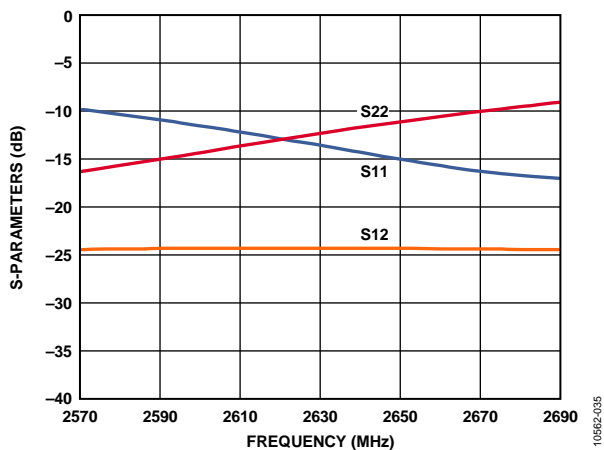

Figure 18. Input Return Loss (S11), Output Return Loss (S22), and Reverse Isolation (S12) vs. Frequency, 2570 MHz to 2690 MHz

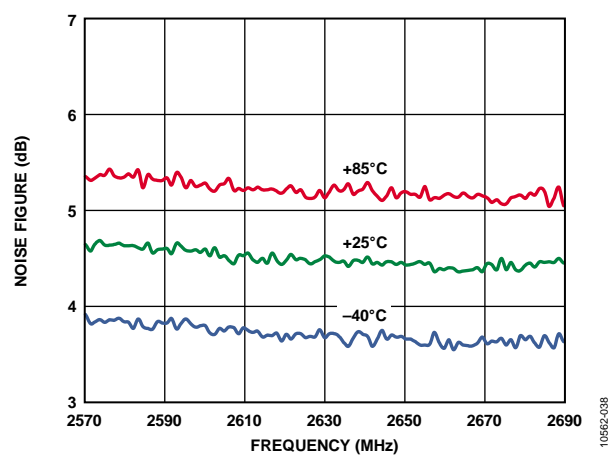

Figure 21. Noise Figure vs. Frequency and Temperature, 2570 MHz to 2690 MHz

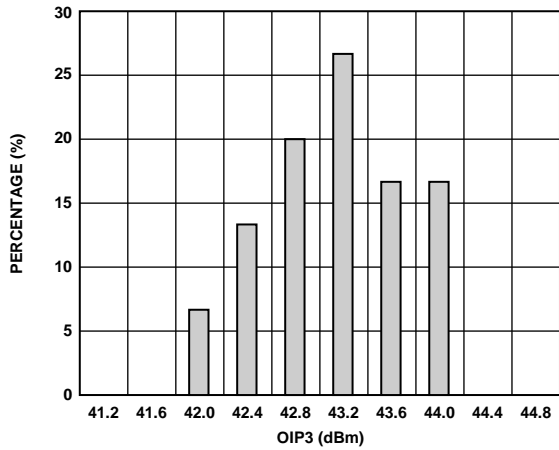

Figure 22. OIP3 Distribution at 2140 MHz

10562-045

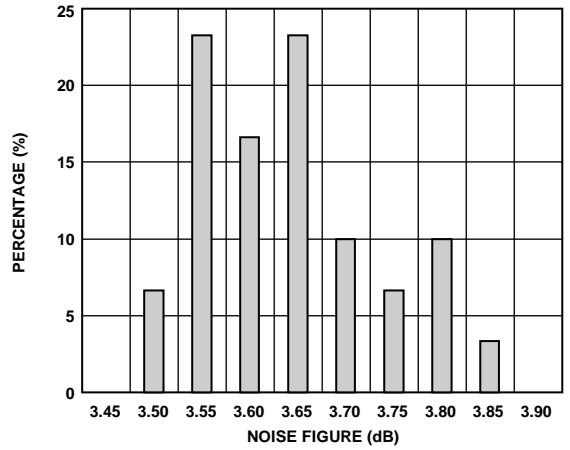

Figure 25. Noise Figure Distribution at 2140 MHz

10562-048

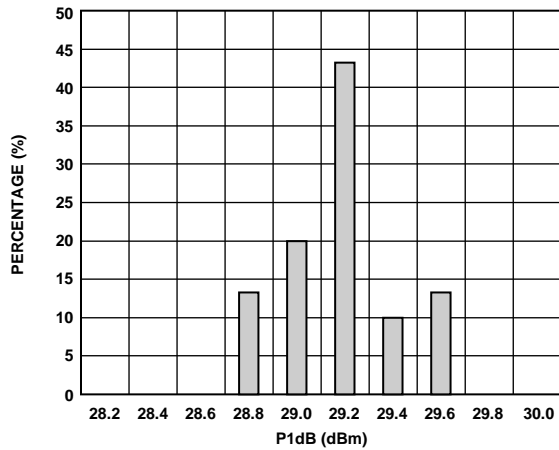

Figure 23. P1dB Distribution at 2140 MHz

10562-046

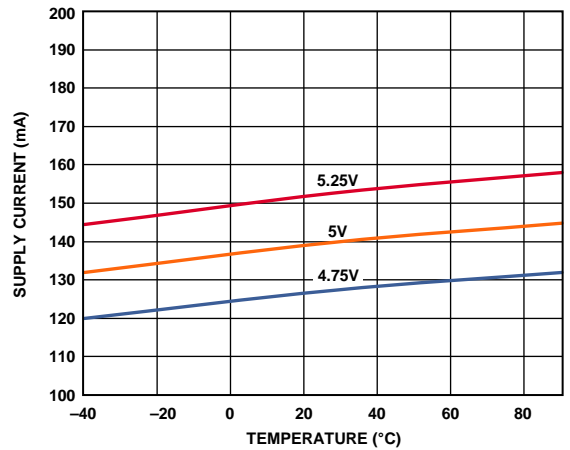

Figure 26. Supply Current vs. Supply Voltage and Temperature, 5 V (Using 2140 MHz Matching Components)

10562-049

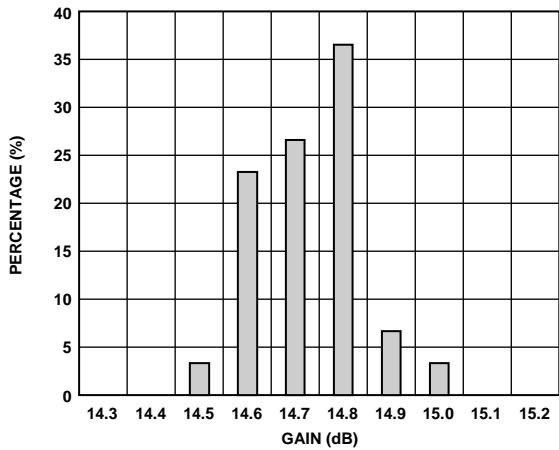

Figure 24. Gain Distribution at 2140 MHz

10562-047

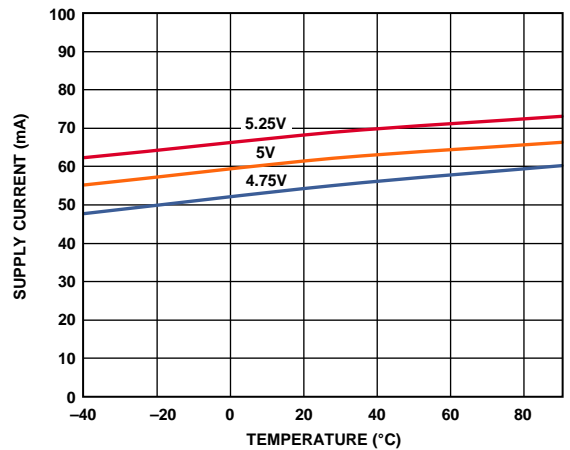

Figure 27. Supply Current vs. Supply Voltage and Temperature, 3.3 V (Using 2140 MHz Matching Components)

10562-064

HIGH TEMPERATURE OPERATION

The ADL5324 has excellent performance at temperatures above 85°C. At 105°C, the gain and P1dB decrease by 0.2 dB, the OIP3 decreases by 0.1 dB, and the noise figure increases by 0.31 dB compared with the data at 85°C. Figure 28 through Figure 30 show the performance at 105°C.

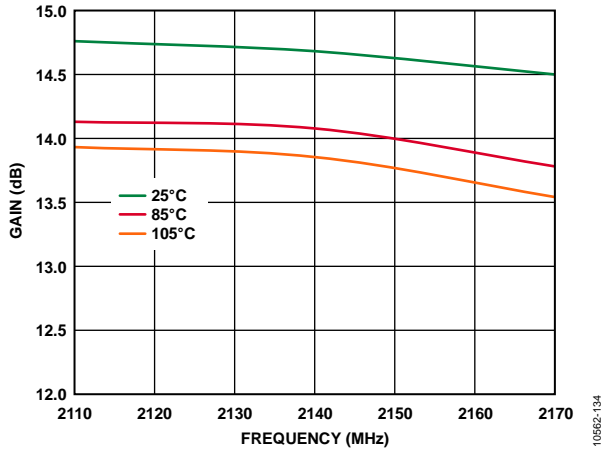

Figure 28. Gain vs. Frequency and Temperature, 5 V Supply, 2140 MHz

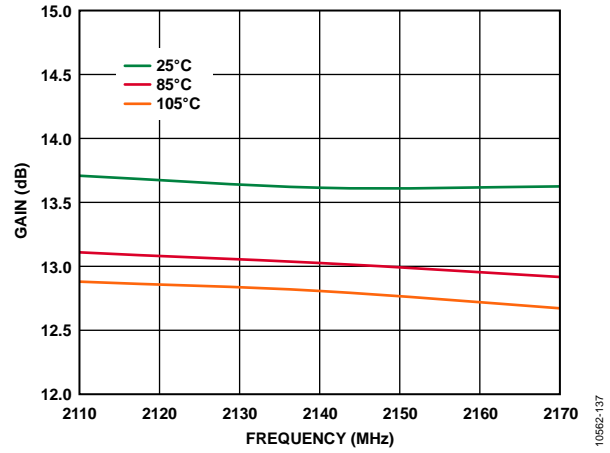

Figure 31. Gain vs. Frequency and Temperature, 3.3 V Supply, 2140 MHz

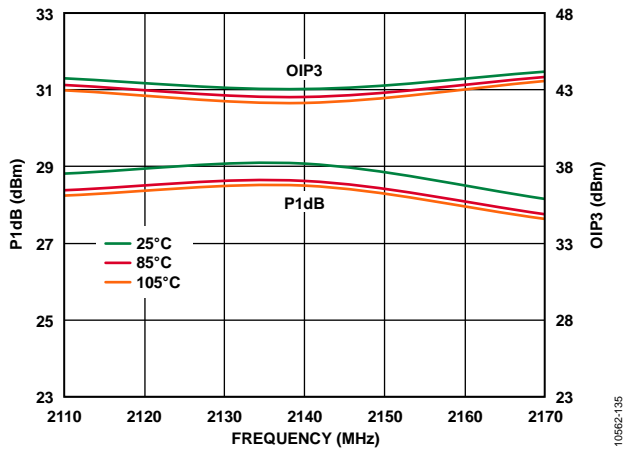

Figure 29. OIP3 and P1dB vs. Frequency and Temperature, 5 V Supply, 2140 MHz

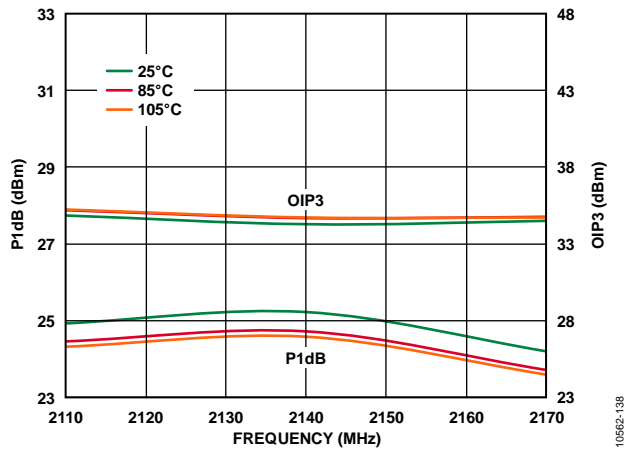

Figure 32. OIP3 and P1dB vs. Frequency and Temperature, 3.3 V Supply, 2140 MHz

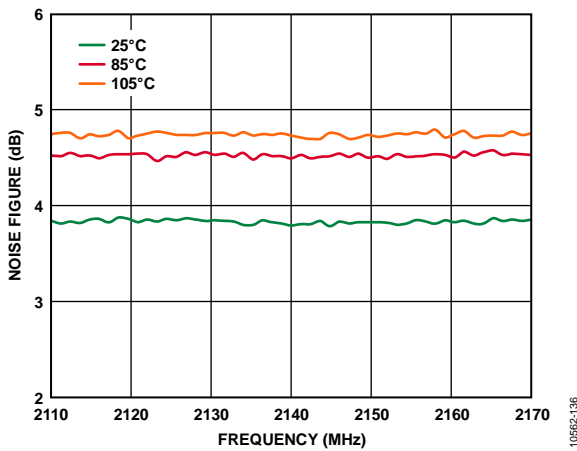

Figure 30. Noise Figure vs. Frequency and Temperature, 5 V Supply, 2140 MHz

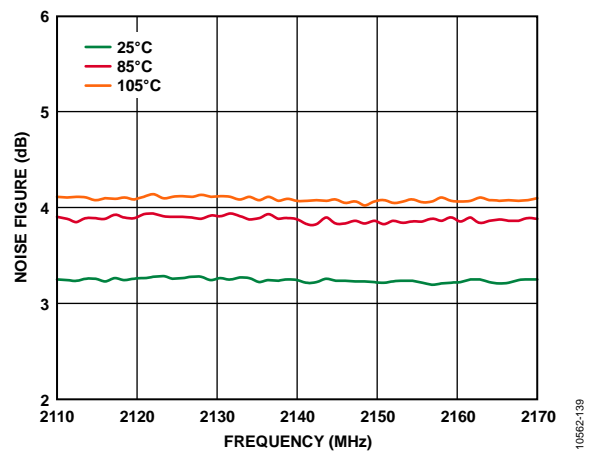

Figure 33. Noise Figure vs. Frequency and Temperature, 3.3 V Supply, 2140 MHz

APPLICATIONS INFORMATION

BASIC LAYOUT CONNECTIONS

The basic connections for operating the ADL5324 are shown in Figure 34. Table 6 lists the required matching components. Capacitors C1, C2, and C3 are Murata GRM615 series (0402 size) High Q capacitors and C7 is a Murata GRM155 series (0402 size). Inductor L1 is a Coilcraft 0603CS series (0603 size). For all frequency bands, the placement of C1 and C2 are critical. The placement of C3 becomes critical for the following bands: 1880 MHz to 1990 MHz, 2110 MHz to 2170 MHz, 2300 MHz to 2400 MHz, 2570 MHz to 2690 MHz, and 3500 MHz to 3600 MHz. For operation from 420 MHz to 494 MHz, 728 MHz to 768 MHz, and 869 MHz to 960 MHz, R2 is replaced with a Coilcraft (0402 size) High Q inductor. Table 7 lists the recommended component placement for various frequencies.

A 5 V dc bias is supplied through L1, which is connected to RFOUT (Pin 3). In addition to C4, 10 nF and 10 μF power supply decoupling capacitors are also required. The typical current consumption for the ADL5324 is 140 mA.

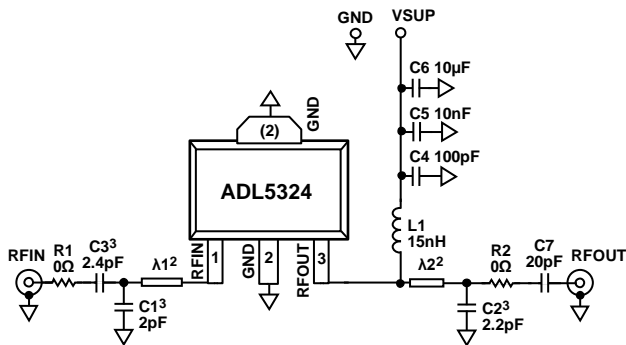

- ¹SEE THE RECOMMENDED COMPONENTS FOR BASIC CONNECTIONS TABLE FOR FREQUENCY-SPECIFIC COMPONENTS.
- ²SEE TABLE 6 FOR RECOMMENDED COMPONENT SPACING.
- ³C1, C2, AND C3 ARE MURATA HIGH Q CAPACITORS GRM615 SERIES.

Figure 34. Basic Connections

10562-050

SOLDERING INFORMATION AND RECOMMENDED PCB LAND PATTERN

Figure 35 shows the recommended land pattern for the ADL5324. To minimize thermal impedance, the exposed paddle on the SOT-89 package underside is soldered to a ground plane along with Pin 2. If multiple ground layers exist, they should be stitched together using vias. For more information on land pattern design and layout, refer to the Application Note AN-772, *A Design and Manufacturing Guide for the Lead Frame Chip Scale Package (LFCSP)*.

This land pattern, on the ADL5324 evaluation board, provides a measured thermal resistance (θ_{JA}) of 37°C/W. To measure θ_{JA} , the temperature at the top of the SOT-89 package is found with an IR temperature gun. Thermal simulation suggests a junction temperature 10°C higher than the top of package temperature. With additional ambient temperature and I/O power measurements, θ_{JA} could be determined.

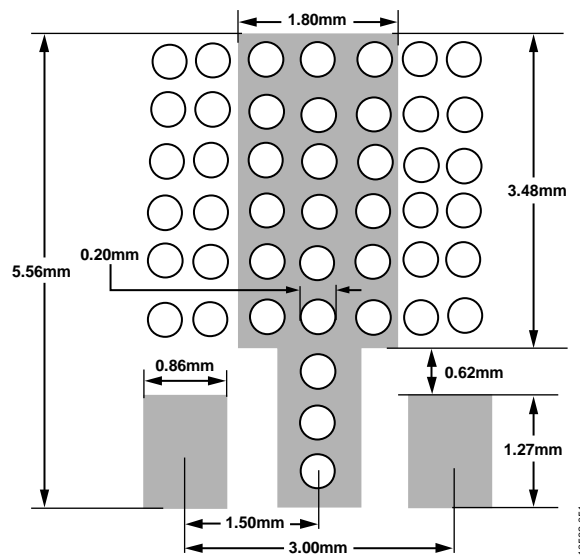

Figure 35. Recommended Land Pattern

10562-051

Table 6. Recommended Components for Basic Connections

Function/ Component	420 MHz to 494 MHz	728 MHz to 768 MHz	800 MHz to 960 MHz	1880 MHz to 1990 MHz	2110 MHz to 2170 MHz (Default)	2300 MHz to 2400 MHz	2560 MHz to 2690 MHz	3500 MHz to 3700 MHz
AC Coupling Capacitors C3 = 0402 C7 = 0402	10 pF 20 pF	10pF ¹ 20 pF	10 pF ¹ 20 pF	2.4 pF ¹ 20 pF	2.4 pF ¹ 20 pF	2.4 pF ¹ 20 pF	2pF ¹ 20 pF ¹	1pF ¹ 20 pF
Power Supply Bypassing Capacitors C4 = 0402 C5 = 0603 C6 = 1206	100 pF 10 nF 10 μF	100 pF 10 nF 10 μF	100 pF 10 nF 10 μF	100 pF 10 nF 10 μF	100 pF 10 nF 10 μF	100 pF 10 nF 10 μF	100 pF 10 nF 10 μF	100 pF 10 nF 10 μF
DC Bias Inductor L1 = 0603CS	120 nH	18 nH	18 nH	15 nH	15 nH	15 nH	15 nH	15 nH
Tuning Capacitors C1 = 0402 C2 = 0402	20 pF ¹ 6.2 pF ¹	8 pF ¹ 3.9 pF ¹	8 pF ¹ 3.6 pF ¹	2.4 pF ¹ 2.4 pF ¹	2.0 pF ¹ 2.2 pF ¹	1.5 pF ¹ 2.0 pF ¹	1.0 pF ¹ 2.0 pF ¹	0.5 pF ¹ 0.75 pF ¹
Jumpers R1 = 0402 R2 = 0402	2 Ω 5.6 nH ²	2 Ω 2.4 nH ³	2 Ω 2.4 nH ³	0 Ω 0 Ω	0 Ω 0 Ω	0 Ω 0 Ω	0 Ω 0 Ω	0 Ω 4.7 nH ³
Power Supply Connections VSUP GND	Red test loop Black test loop							

¹ Murata High Q capacitor.

² Add a 1.6 nH at input (see Figure 41).

³ Coilcraft 0402CS series.

Table 7. Matching Component Spacing

Frequency (MHz)	λ1 (mils)	λ2 (mils)
420 to 494	419	438
728 to 768	311	422
869 to 961	207	413
1880 to 1990	75	239
2110 to 2170	65	193
2300 to 2400	71	176
2570 to 2690	245	132
3500 to 3700	316	125

MATCHING PROCEDURE

The ADL5324 is designed to achieve excellent gain and OIP3 performance. To achieve this, both input and output matching networks must present specific impedance to the device. The matching components listed in Table 7 were chosen to provide -10 dB input return loss while maximizing OIP3.

The load-pull plots (see Figure 36 and Figure 37) show the load impedance points on the Smith chart where optimum OIP3, gain, and output power can be achieved. These load impedance values (that is, the impedance that the device sees when looking into the output matching network) are listed in Table 8 and Table 9 for maximum gain and maximum OIP3, respectively. The contours show how each parameter degrades as it is moved away from the optimum point.

From the data shown in Table 8 and Table 9, it becomes clear that maximum gain and maximum OIP3 do not occur at the same impedance. This can also be seen on the load-pull contours in Figure 36 and Figure 37. Thus, output matching generally involves compromising between gain and OIP3. In addition, the load-pull plots demonstrate that the quality of the output impedance match must be compromised to optimize gain and/or OIP3. In most applications where line lengths are short and where the next device in the signal chain presents a low input return loss, compromising on the output match is acceptable.

To adjust the output match for operation at a different frequency, or if a different trade-off between OIP3, gain, and output impedance is desired, a four-step procedure is recommended.

For example, to optimize the ADL5324 for optimum OIP3 and gain at 750 MHz, use the following steps:

1. Install the recommended tuning components for an 869 MHz to 970 MHz tuning band, but do not install C1 and C2.
2. Connect the evaluation board to a vector network analyzer so that input and output return loss can be viewed simultaneously.
3. Starting with the recommended values and positions for C1 and C2, adjust the positions of these capacitors along the transmission line until the return loss and gain are acceptable. In this case, push-down capacitors mounted on small sticks can be used as an alternative to soldering. If moving the component positions does not yield satisfactory results, then increase or decrease the values of C1 and C2 (in this case, the values are most likely increased because the user is tuning for a lower frequency).

4. Repeat Step 3 as necessary. Once the desired gain and return loss are realized, measure OIP3. Most likely, it will be necessary to go back and forth between return loss/gain and OIP3 measurements (probably compromising most on output return loss) until an acceptable compromise is achieved.

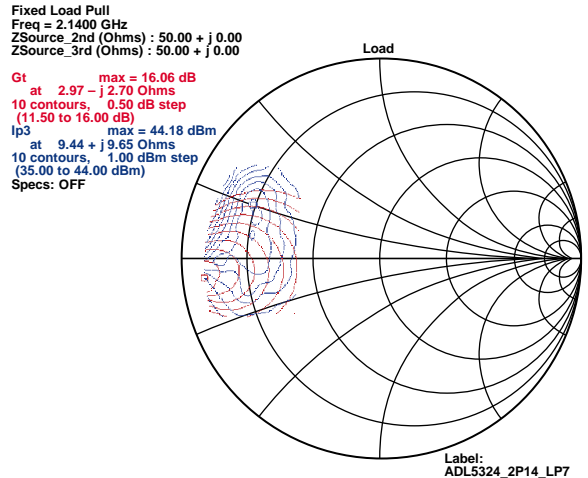

Figure 36. Load-Pull Contours, 2140 MHz

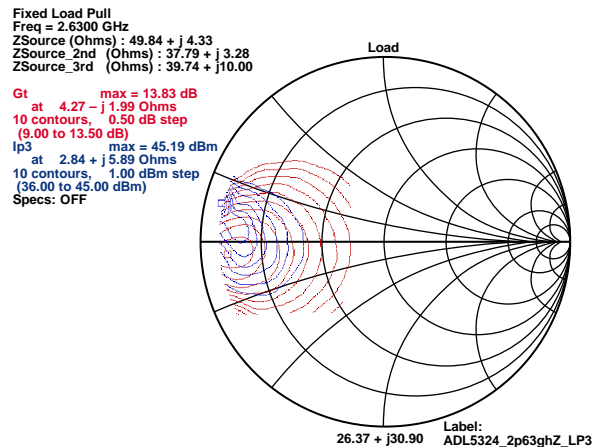

Figure 37. Load-Pull Contours, 2600 MHz

Table 8. Load Conditions for Gain_{MAX}

Frequency (MHz)	ΓLoad (Magnitude)	ΓLoad (°)	Gain _{MAX} (dB)
2140	0.888	-173.55	16.1
2630	0.0843	-175.41	13.83

Table 9. Load Conditions for OIP3_{MAX}

Frequency (MHz)	ΓLoad (Magnitude)	ΓLoad (°)	IP3 _{MAX} (dBm)
2140	0.654	+163.28	44.18
2630	0.894	+166.52	45.19

W-CDMA ACPR PERFORMANCE

Figure 38 shows a plot of adjacent channel power ratio (ACPR) vs. P_{OUT} for the ADL5324. The signal type used is a single W-CDMA carrier (Test Model 1-64) at 2140 MHz. This signal is generated by a very low ACPR source. ACPR is measured at the output by a high dynamic range spectrum analyzer, which incorporates an instrument noise correction function.

The ADL5324 achieves an ACPR of -79 dBc at 0 dBm output, at which point device noise and not distortion is beginning to

dominate the power in the adjacent channels. At an output power of 10 dBm, ACPR is still very low at -72 dBc, making the device particularly suitable for PA driver applications.

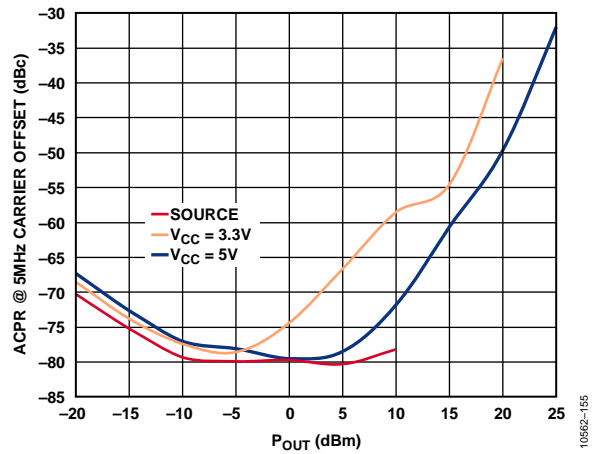
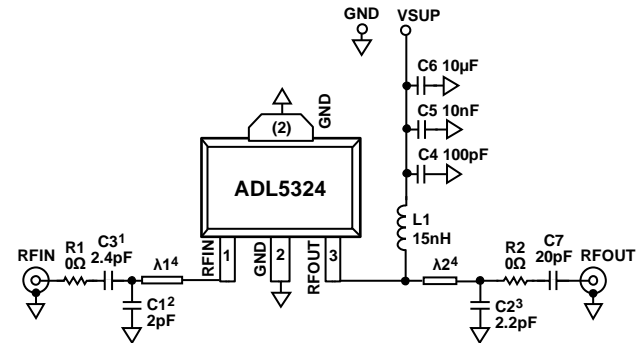

Figure 38. ACPR vs. Output Power, Single Carrier W-CDMA, TM1-64, at 2140 MHz

EVALUATION BOARD

The schematic of the ADL5324 evaluation board is shown in Figure 39. This evaluation board uses 25 mil wide traces and is made from FR4 material. The evaluation board comes tuned for operation in the 2110 MHz to 2170 MHz tuning band. Tuning options for other frequency bands are also provided in Table 9. The recommended placement for these components is provided in Table 10. The inputs and outputs should be ac-coupled with appropriately sized capacitors. dc bias is provided to the amplifier via an inductor connected to the RFOUT pin. A bias voltage of 5 V is recommended.



- 1MURATA HIGH Q CAPACITOR GRM615COG2R4B50 OR EQUIVALENT.
- 2MURATA HIGH Q CAPACITOR GRM615COG020B50 OR EQUIVALENT.
- 3MURATA HIGH Q CAPACITOR GRM615COG2R2B50 OR EQUIVALENT.
- 4SEE TABLE 10 FOR RECOMMENDED COMPONENT SPACING.

Figure 39. Evaluation Board, 2110 MHz to 2170 MHz

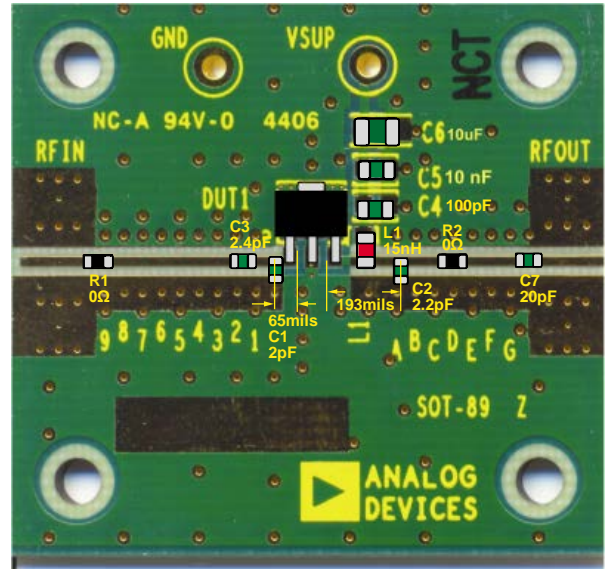

Figure 40. Evaluation Board Layout and Default Component Placement for 2110 MHz to 2170 MHz

Table 10. Recommended Components for Basic Connections

Function/ Component	420 MHz to 494 MHz	728 MHz to 768 MHz	800 MHz to 960 MHz	1880 MHz to 1990 MHz	2110 MHz to 2170 MHz (Default)	2300 MHz to 2400 MHz	2560 MHz to 2690 MHz	3500 MHz to 3700 MHz
AC Coupling Capacitors								
C3 = 0402	10 pF	10pF ¹	10 pF	2.4 pF ¹	2.4 pF ¹	2.4 pF ¹	2pF ¹	1pF ¹
C7 = 0402	20 pF	20 pF	20 pF	20 pF	20 pF	20 pF	20 pF ¹	20 pF
Power Supply Bypassing Capacitors								
C4 = 0402	100 pF	100 pF	100 pF	100 pF	100 pF	100 pF	100 pF	100 pF
C5 = 0603	10 nF	10 nF	10 nF	10 nF	10 nF	10 nF	10 nF	10 nF
C6 = 1206	10 μF	10 μF	10 μF	10 μF	10 μF	10 μF	10 μF	10 μF
DC Bias Inductor L1 = 0603CS	120 nH	18 nH	18 nH	15 nH	15 nH	15 nH	15 nH	15 nH
Tuning Capacitors								
C1 = 0402	20 pF ¹	8 pF ¹	8 pF ¹	2.4 pF ¹	2.0 pF ¹	1.5 pF ¹	1.0 pF ¹	0.5 pF ¹
C2 = 0402	6.2 pF ¹	3.9 pF ¹	3.6 pF ¹	2.4 pF ¹	2.2 pF ¹	2.0 pF ¹	2.0 pF ¹	0.75 pF ¹
Jumpers								
R1 = 0402	2 Ω	2 Ω	2 Ω	0 Ω	0 Ω	0 Ω	0 Ω	0 Ω
R2 = 0402	5.6 nH ²	2.4 nH ³	2.4 nH ³	0 Ω	0 Ω	0 Ω	0 Ω	4.7 nH ³
Power Supply Connections								
VSUP					Red test loop			
GND					Black test loop			

¹ Murata High Q capacitor.
² Add a 1.6 nH at input (see Figure 41).
³ Coilcraft 0402CS series.

Table 11. Recommended Component Spacing on Evaluation Board

Frequency (MHz)	$\lambda 1$ (mils)	$\lambda 2$ (mils)
420 to 494	419	438
728 to 768	311	422
869 to 961	207	413
1880 to 1990	75	239
2110 to 2170	65	193
2300 to 2400	71	176
2570 to 2690	245	132
3500 to 3700	316	125

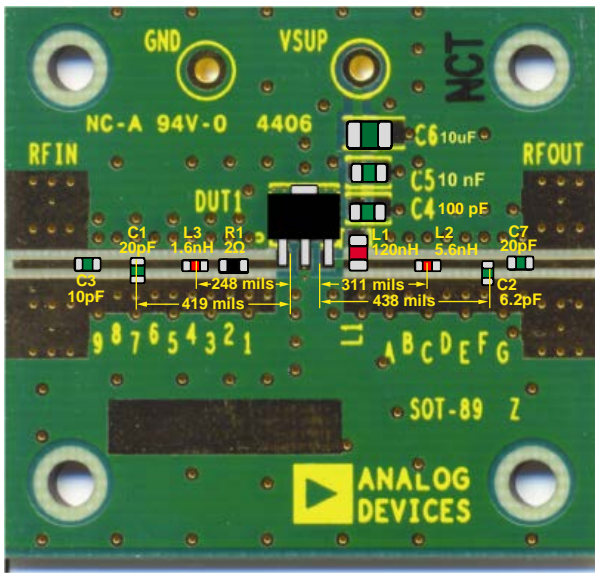

Figure 41. Evaluation Board Layout and Component Placement, 420 MHz to 494 MHz Operation

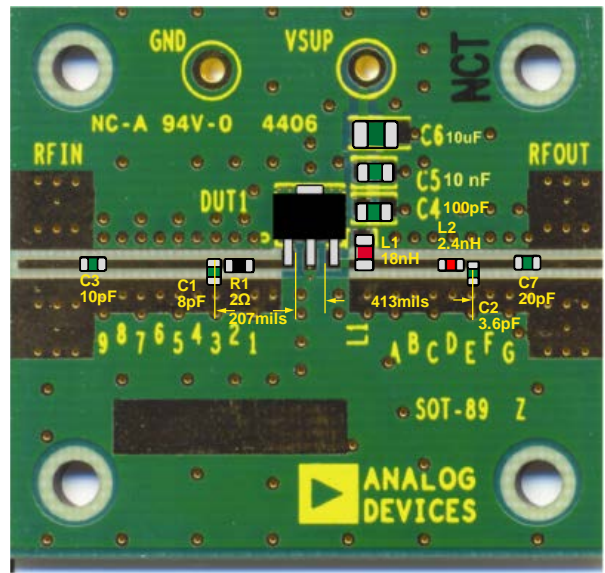

Figure 43. Evaluation Board Layout and Component Placement, 869 MHz to 961 MHz Operation

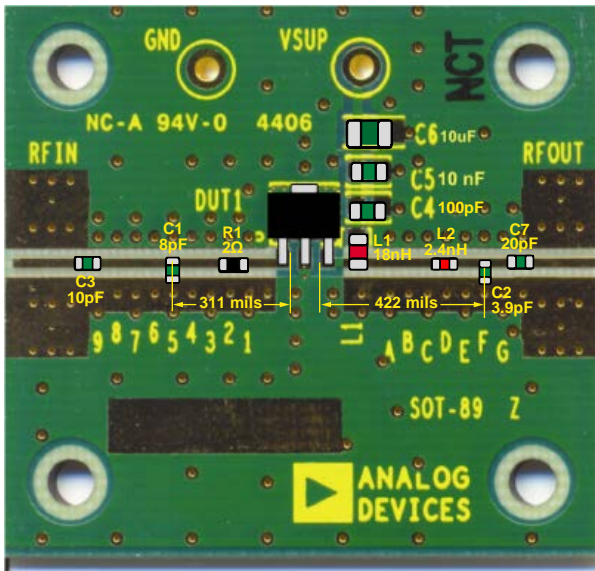

Figure 42. Evaluation Board Layout and Component Placement, 728 MHz to 768 MHz Operation

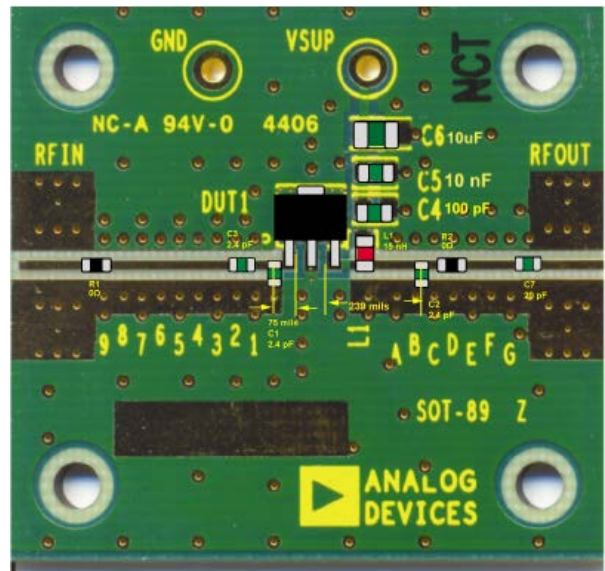
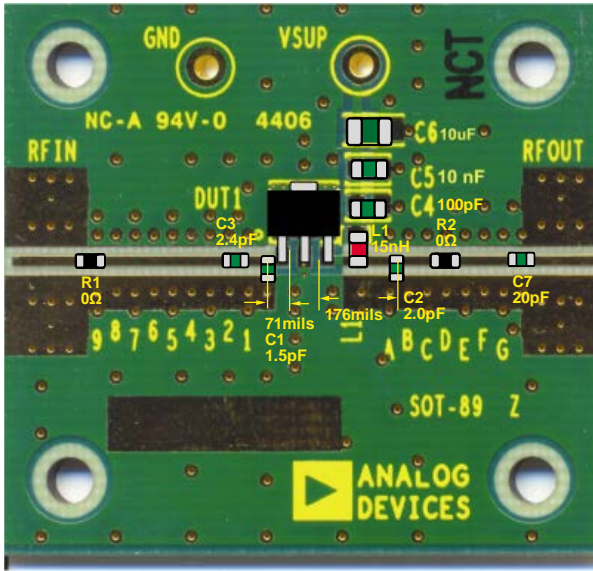
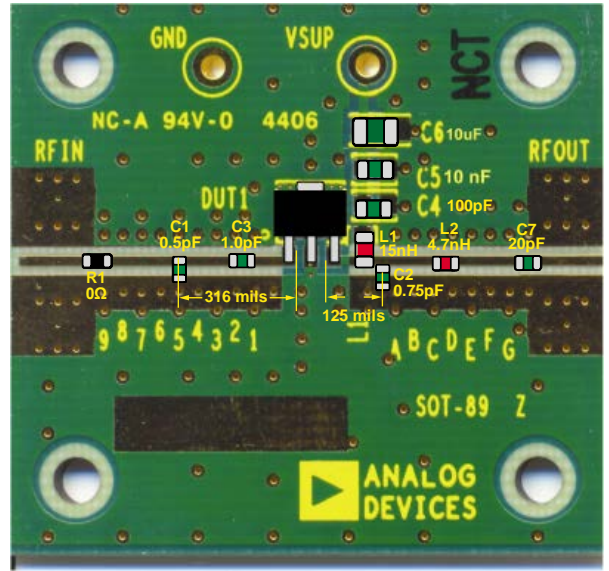

Figure 44. Evaluation Board Layout and Component Placement, 1880 MHz to 1990 MHz Operation



10562-062

Figure 45. Evaluation Board Layout and Component Placement, 2300 MHz to 2400 MHz Operation



10562-148

Figure 47. Evaluation Board Layout and Component Placement, 3500 MHz to 3700 MHz Operation

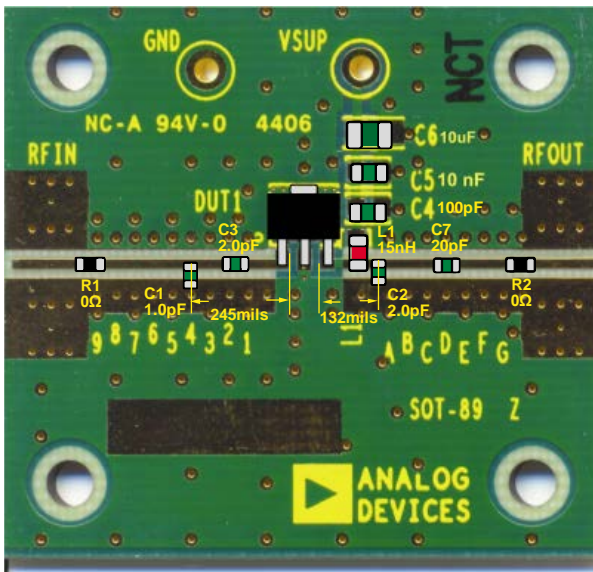

10562-063

Figure 46. Evaluation Board Layout and Component Placement, 2560 MHz to 2690 MHz Operation

OUTLINE DIMENSIONS

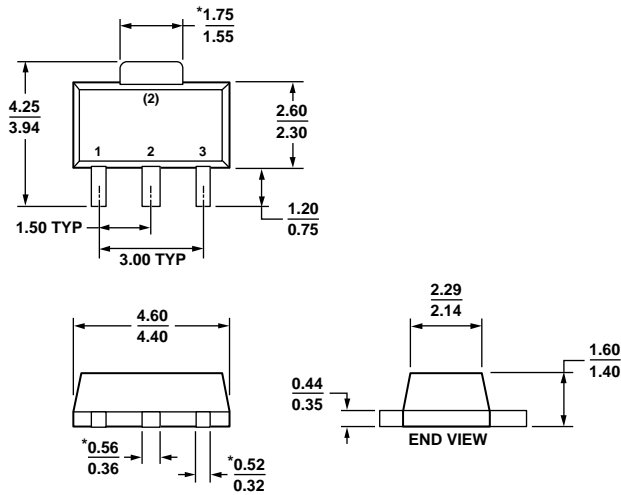

*COMPLIANT TO JEDEC STANDARDS TO-243 WITH THE EXCEPTION OF DIMENSIONS INDICATED BY AN ASTERISK.

Figure 48. 3-Lead Small Outline Transistor Package [SOT-89] (RK-3)

Dimensions shown in millimeters

12-18-2008-B

ORDERING GUIDE

Model ¹	Temperature Range	Package Description	Package Option
ADL5324ARKZ-R7	-40°C to +105°C	3-Lead SOT-89, 7" Tape and Reel	RK-3
ADL5324-EVALZ		Evaluation Board	

¹ Z = RoHS Compliant Part.