

Contents

Product Program	2
Mechanical Data	2
Connections	3
Absolute Maximum Ratings	3
Input	3
Product Qualification Specification	4
Safety Specification	5
Adjusted to 1.0 V out - Data	6
Adjusted to 1.2 V out - Data	9
Adjusted to 1.5 V out - Data	12
Adjusted to 1.8 V out - Data	15
Adjusted to 2.5 V out - Data	18
Adjusted to 3.3 V out - Data	21
EMC Specification	24
Operating Information	24
Thermal Considerations	27
Soldering Information	28
Delivery Package Information	28
Reliability	28
Compatibility with RoHS requirements	28
Sales Offices and Contact Information	29

The PMB series of SIL DC/DC regulators (POL) are intended to be used as local distributed power sources in distributed power architecture level 4. The single in-line design makes the PMB series suitable for applications where board space is limited. The high efficiency and high reliability of the PMB series makes them particularly suited for the communications equipment of today and tomorrow.

DC/DC regulator Input 3.0 - 5.5 V Output 10 A

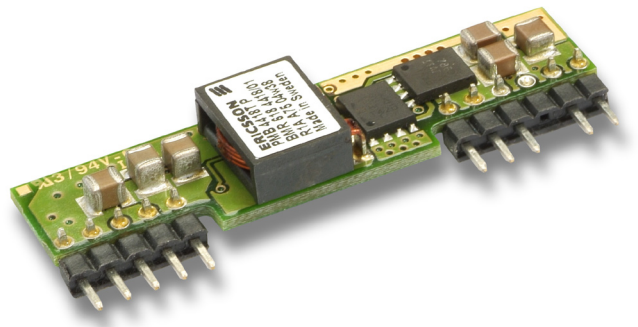

Key Features

- Wide input, 3.0-5.5 Vdc
- Programmable output, 0.75 - 3.6 Vdc
- Under voltage protection
- Short circuit protection
- Remote sense
- Remote On/Off
- Design for Environment (DfE)
- European Commission Directive 2002/95/EC (RoHS) compliant

These products are manufactured using the most advanced technologies and materials to comply with environmental requirements. Designed to meet high reliability requirements of systems manufacturers, the PMB responds to world-class specifications.

Ericsson Power Modules is an ISO 9001/14001 certified supplier.

Product Program

V _I	V _O /I _O max	P _O max	Ordering No.	Comment
	Output 1			
3.0-5.5 V*	0.8-3.6 V/10 A	33 W	PMB 4418T WP	Standard version
3.0-5.5 V	1.0 V/10 A	10 W	PMB 4118N WP	On request
3.0-5.5 V	1.2 V/10 A	12 W	PMB 4118L WP	On request
3.0-5.5 V	1.5 V/10 A	15 W	PMB 4118H WP	Released
3.0-5.5 V	1.8 V/10 A	18 W	PMB 4118G WP	Released
3.0-5.5 V	2.5 V/10 A	25 W	PMB 4219 WP	Released
3.8-5.5 V	3.3 V/10 A	33 W	PMB 4310 WP	Released
Option		Suffix	Example	
Positive Remote Control logic		P	PMB 4418T WPP	

* Input voltage limited to 3.8-5.5V for 3.3 V_{out} and for output voltages of 3.3V and 4.5-5.5 for output voltages above 3.3V.

Ordering Information

Delivery option	M.o.q.	Suffix	Example
Tray	100 pcs	/B	PMB 4xxxx WP /B

Mechanical Data

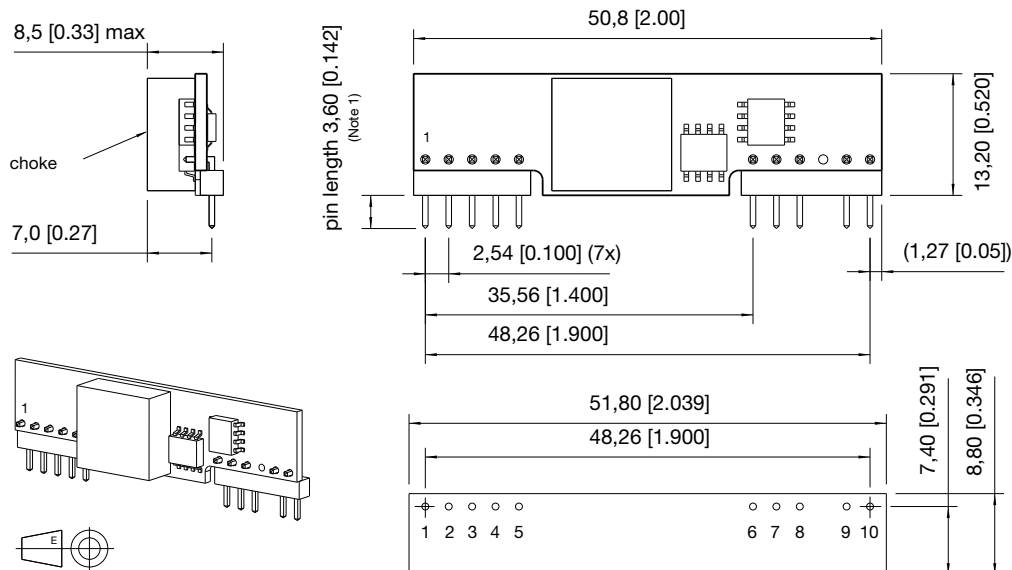

Dimensions in mm [inch]

Tolerances (unless specified):
 x,x +/-0,5 [0.02]
 x,xx +/-0,25 [0.01]

Recommended footprint (customer board), no components within border.
 Holes: Ø1,0 [0.04] through plated holes with Ø1,5 [0.06] pads on both sides.

Note 1: For other pin lengths, refer to Product program/Ordering information

Connections

Pin	Designation	Function
1	+ Out	Positive output
2	+ Out	Positive output
3	+ Sense	Positive sense
4	+ Out	Positive output
5	GND	Ground
6	GND	Ground
7	+ In	Positive input
8	+ In	Positive input
9	Vadj	Output voltage adjust
10	RC	Remote control

Weight

7.7g

Pins

Material: Copper alloy

Plating: Matte tin over nickel

Absolute Maximum Ratings

Characteristics		min	typ	max	Unit
T_{ref}	Operating Reference Temperature, see pg. 27	-45		+115	°C
T_S	Storage temperature	-55		+125	°C
V_I	Input voltage	-0.3		+5.5	Vdc

Stress in excess of Absolute Maximum Ratings may cause permanent damage. Absolute Maximum Ratings, sometimes referred to as no destruction limits, are normally tested with one parameter at a time exceeding the limits of Output data or Electrical Characteristics. If exposed to stress above these limits, function and performance may degrade in an unspecified manner.

Input

$T_{ref} = -30 \dots +90 \text{ °C}$, $V_I = 3.0 \dots 5.5 \text{ V}$ unless otherwise specified
Typ values specified at: $T_{ref} = +25 \text{ °C}$, V_{Inom} , $I_{Omax} = 10 \text{ A}$

Characteristics		Conditions	min	typ	max	Unit
V_I	Input voltage range		3.0		5.5	Vdc
V_{Ioff}	Turn-off input voltage	Ramp from higher voltage, V_{out} set to 1.0-1.8 V		1.9		Vdc
		Ramp from higher voltage, V_{out} set to 2.5 V		2.5		
		Ramp from higher voltage, V_{out} set to 3.3 V		3.5		
V_{Ion}	Turn-on input voltage	Ramp from lower voltage, V_{out} set to 1.0-1.8 V		2.1		Vdc
		Ramp from lower voltage, V_{out} set to 2.5 V		2.7		
		Ramp from lower voltage, V_{out} set to 3.3 V		3.6		
C_I	Input capacitance			20		μF
P_{Ii}	Input idling power	$I_O = 0 \text{ A}$, $V_I = 5 \text{ V}$			590	mW
P_{RC}	Input stand-by power (RC active)	Non operation, $V_I = 5 \text{ V}$			7.5	mW
V_{Iac}	Input ripple 1)	20 Hz ... 5 MHz, I_{Omax} , $V_I = 5 \text{ V}$		400		mV

1) Measured with 2 x 22 μF ceramic capacitors

Fundamental Circuit Diagram

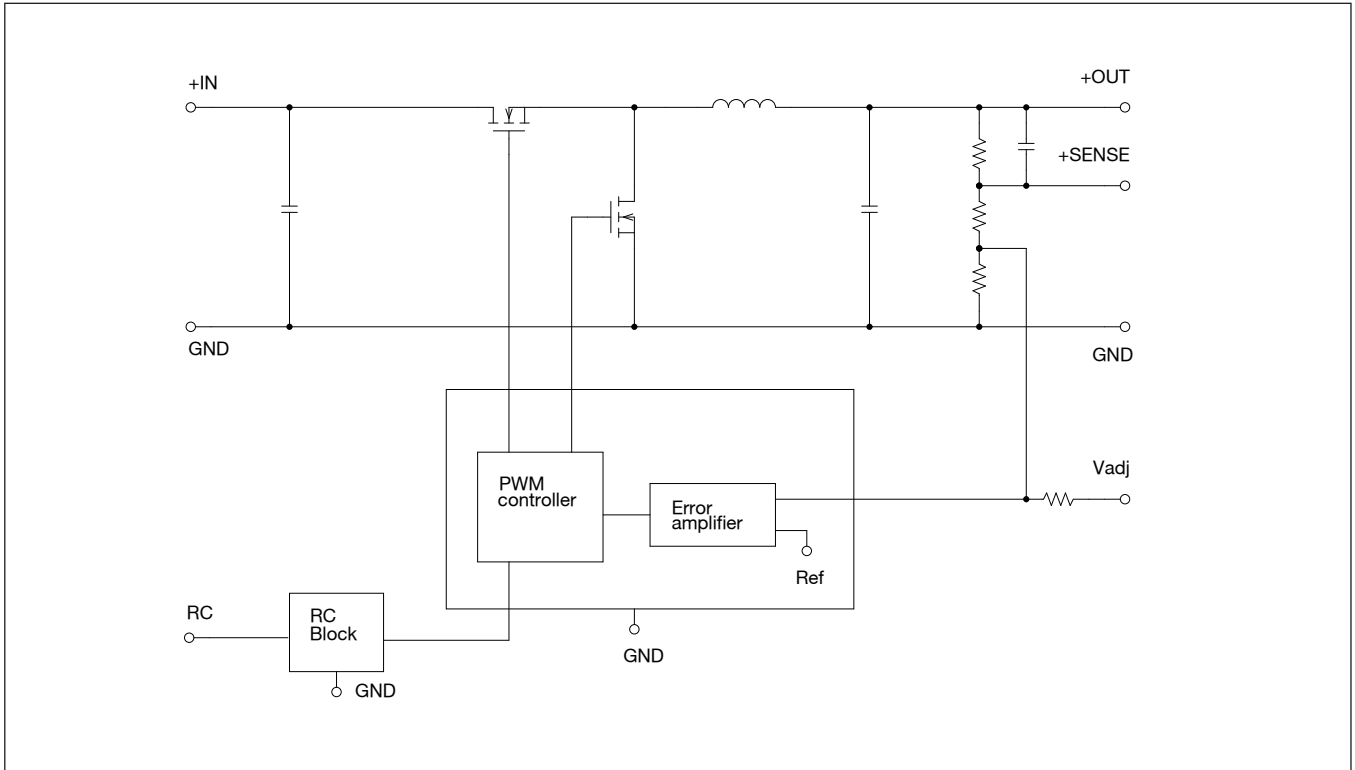

Product Qualification Specification

Characteristics			
Random Vibration	IEC 60068-2-64	Frequency Acceleration density	5 ... 500 Hz 0.5 g ² /Hz
Mechanical shock (half sinus)	IEC 60068-2-27	Peak acceleration Duration	50 g 11 ms
Lead integrity	IEC 60068-2-21 Ub	Simultaneous bending	All leads
Temperature cycling	JESD22-A104-B _G	Temperature Number of cycles	-40 ... +125 °C 300
Accelerated damp heat	JESD22-A101-B	Temperature Humidity Duration Bias	+85 °C 85 % RH 1000 hours max input voltage
Solderability	IEC 60068-2-54 (Aged according to JESD22-A101-B, 240h no bias)	Solder immersion depth Time for onset of wetting Wetting force	2 mm < 2.5 s > 200 mN/m
Cold (in operation)	IEC 60068-2-1	Temperature Duration	-45 °C 72 h
High temperature storage	JESD22-A103-B _A	Temperature Duration	+125 °C 1000 h

Safety Specification

General information.

Ericsson Power Modules DC/DC converters and DC/DC regulators are designed in accordance with safety standards IEC/EN/UL 60 950, *Safety of Information Technology Equipment*.

IEC/EN/UL60950 contains requirements to prevent injury or damage due to the following hazards:

- *Electrical shock*
- *Energy hazards*
- *Fire*
- *Mechanical and heat hazards*
- *Radiation hazards*
- *Chemical hazards*

On-board DC-DC converters are defined as component power supplies. As components they cannot fully comply with the provisions of any Safety requirements without "Conditions of Acceptability". It is the responsibility of the installer to ensure that the final product housing these components complies with the requirements of all applicable Safety standards and Directives for the final product.

Component power supplies for general use should comply with the requirements in IEC60950, EN60950 and UL60950 "Safety of information technology equipment".

There are other more product related standards, e.g. IEC61204-7 "Safety standard for power supplies", IEEE802.3af "Ethernet LAN/MAN Data terminal equipment power", and ETS300132-2 "Power supply interface at the input to telecommunications equipment; part 2: DC", but all of these standards are based on IEC/EN/UL60950 with regards to safety.

Ericsson Power Modules DC/DC converters and DC/DC regulators are UL 60 950 recognized and certified in accordance with EN 60 950.

The flammability rating for all construction parts of the products meets UL 94V-0.

The products should be installed in the end-use equipment, in accordance with the requirements of the ultimate application. Normally the output of the DC/DC converter is considered as SELV (Safety Extra Low Voltage) and the input source must be isolated by minimum Double or Reinforced Insulation from the primary circuit (AC mains) in accordance with IEC/EN/UL 60 950.

Isolated DC/DC converters.

It is recommended that a fast blow fuse with a rating twice the maximum input current per selected product be used at the input of each DC/DC converter. If an input filter is used in the circuit the fuse should be placed in front of the input filter.

In the rare event of a component problem in the input filter or in the DC/DC converter that imposes a short circuit on the input source, this fuse will provide the following functions:

- Isolate the faulty DC/DC converter from the input power source so as not to affect the operation of other parts of the system.
- Protect the distribution wiring from excessive current and power loss thus preventing hazardous overheating.

The galvanic isolation is verified in an electric strength test. The test voltage (V_{ISO}) between input and output is 1500 Vdc or 2250 Vdc for 60 seconds (refer to product specification). Leakage current is less than 1 μ A at nominal input voltage.

24 V dc systems.

The input voltage to the DC/DC converter is SELV (Safety Extra Low Voltage) and the output remains SELV under normal and abnormal operating conditions.

48 and 60 V dc systems.

If the input voltage to Ericsson Power Modules DC/DC converter is 75 V dc or less, then the output remains SELV (Safety Extra Low Voltage) under normal and abnormal operating conditions.

Single fault testing in the input power supply circuit should be performed with the DC/DC converter connected to demonstrate that the input voltage does not exceed 75 V dc.

If the input power source circuit is a DC power system, the source may be treated as a TNV2 circuit and testing has demonstrated compliance with SELV limits and isolation requirements equivalent to Basic Insulation in accordance with IEC/EN/UL 60 950.

Non-isolated DC/DC regulators.

The input voltage to the DC/DC regulator is SELV (Safety Extra Low Voltage) and the output remains SELV under normal and abnormal operating conditions.

It is recommended that a slow blow fuse with a rating twice the maximum input current per selected product be used at the input of each DC/DC regulator.

Adjusted to 1.0 V out - Data

$T_{ref} = -30 \dots +90 \text{ }^\circ\text{C}$, $V_I = 3.0 \dots 5.5 \text{ V}$ unless otherwise specified. Input filter $2 \times 22 \text{ } \mu\text{F}$, Output filter $1 \times 150 \text{ } \mu\text{F}$
 Typ values specified at: $T_{ref} = +25 \text{ }^\circ\text{C}$ and V_{Inom} . $I_{Omax} = 10 \text{ A}$. Note: +Sense connected to +Out

Characteristics		Conditions	Output			Unit
			min	typ	max	
V_{O1}	Output voltage adjusted setting	$T_{ref} = +25 \text{ }^\circ\text{C}$, V_{Inom} , I_{Omax} , $R_{adj} 80 \text{ k}\Omega$		1.00		V
V_O	Output voltage tolerance band	$I_O = 0.01 \dots 1.0 \times I_{Omax}$	0.97		1.03	V
	Idling voltage	$I_O = 0$	0.98		1.02	V
	Line regulation	$V_{Imin} \dots V_{Imax}$, I_{Omax}		11		mV
	Load regulation	$I_O = 0.01 \dots 1.0 \times I_{Omax}$, V_{Inom}		10		mV
V_{tr}	Load transient voltage deviation	Load step = $0.25 \dots 0.75 \times I_{Omax}$, $dl/dt = 5 \text{ A}/\mu\text{s}$, $C_O = 150 \text{ } \mu\text{F}$, $V_I = 3.3 \text{ V}$		140		mV
t_{tr}	Load transient recovery time			60		μs
T_{coeff}	Temperature coefficient	$T_{ref} = -30 \dots +90 \text{ }^\circ\text{C}$, I_{Omax}	-0.1	0	+0.1	$\text{mV}/^\circ\text{C}$
t_s	Start-up time	From V_I connected to $V_O = 0.9 \times V_{O1}$, $I_O = 0.1 \dots 1.0 \times I_{Omax}$, V_{Inom}		8.5		ms
t_r	Ramp-up time	$0.1 \dots 0.9 \times V_O$, $I_O = 0.1 \dots 1.0 \times I_{Omax}$, V_{Inom}		4		ms
t_f	Fall time, $V_O \times 0.1$	$I_O = I_{Omax}$, V_{Inom}		0.2		ms
t_f	Fall time, $V_O \times 0.1$	$I_O = 0 \text{ A}$, V_{Inom}		5		s
t_{RCoff}	RC shut-down time to $V_O \times 0.1$	$I_O = I_{Omax}$, V_{Inom}		0.2		ms
t_{RCOn}	RC start-up time to $V_O \times 0.9$	$I_O = I_{Omax}$, V_{Inom}		8		ms
t_{RC}	RC fall time, $V_O \times 0.1 \dots 0.9$	$I_O = 0 \text{ A}$, V_{Inom}		10		s
I_O	Output current		0		10	A
P_{Omax}	Max output power	At $V_O = V_{Onom}$	10			W
I_{lim}	Current limit threshold	$T_{ref} < T_{refmax}$	15	18	22	A
V_{Oac}	Output ripple	20 Hz ... 5 MHz, I_{Omax}		10	20	mV_{p-p}
η	Efficiency - 50% load	$I_O = 0.5 \times I_{Omax}$, $V_I = 5 \text{ V}$		87		%
η	Efficiency - 100% load	$I_O = I_{Omax}$, $V_I = 5 \text{ V}$	84	85.8		%
P_d	Power Dissipation	$I_O = I_{Omax}$, $V_I = 5 \text{ V}$		1.6	2.0	W
F_o	Switching frequency	$I_O = 0 \dots 1.0 \times I_{Omax}$	250	300	350	kHz
I_{sense}	Remote sense current				8	mA
I_I	Static input current	$V_I = 3.0 \text{ V}$, $I_O = I_{Omax}$, $T_{ref} = 25 \text{ }^\circ\text{C}$		3.9		A
MTBF	Predicted reliability	$T_{ref} = 40 \text{ }^\circ\text{C}$		6		million hours

Adjusted to 1.0 V out - Typical Characteristics

General conditions: Input filter 2 x 22 μ F, Output filter 1 x 150 μ F

Efficiency

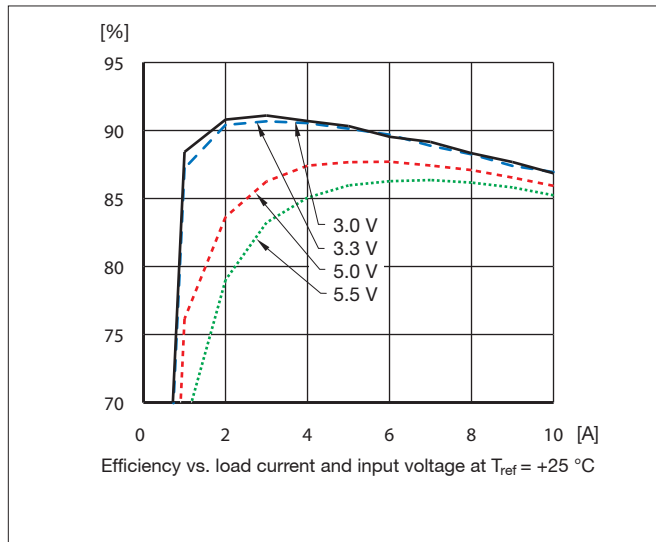

Power Dissipation

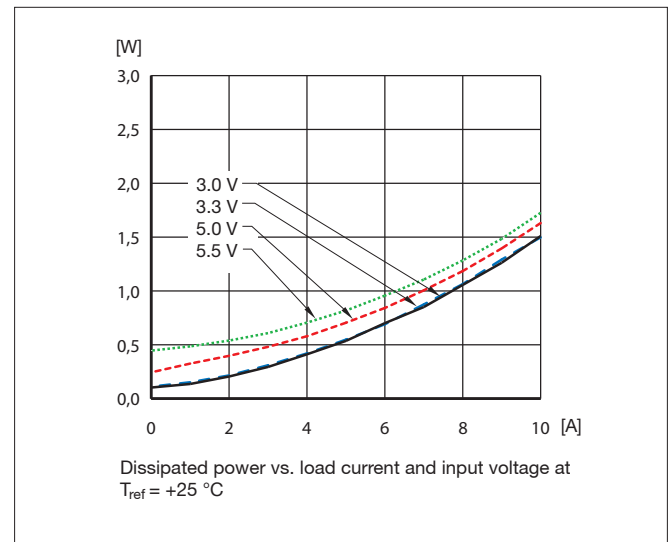

Output Current Derating at 3.3 V input

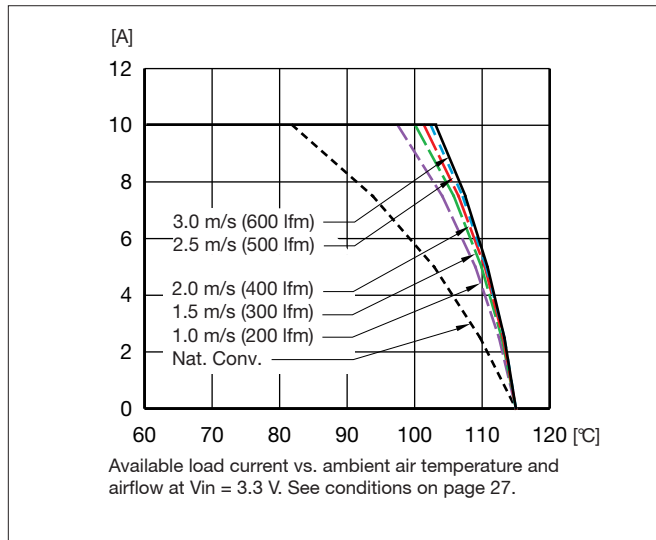

Output Current Derating at 5 V input

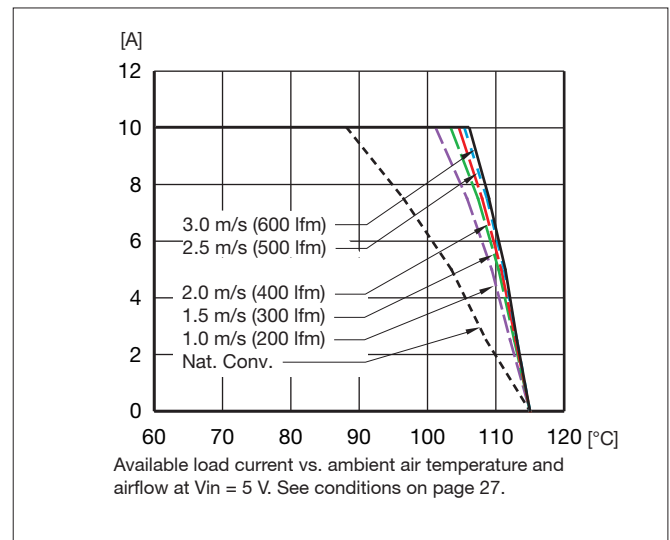

Output Characteristics

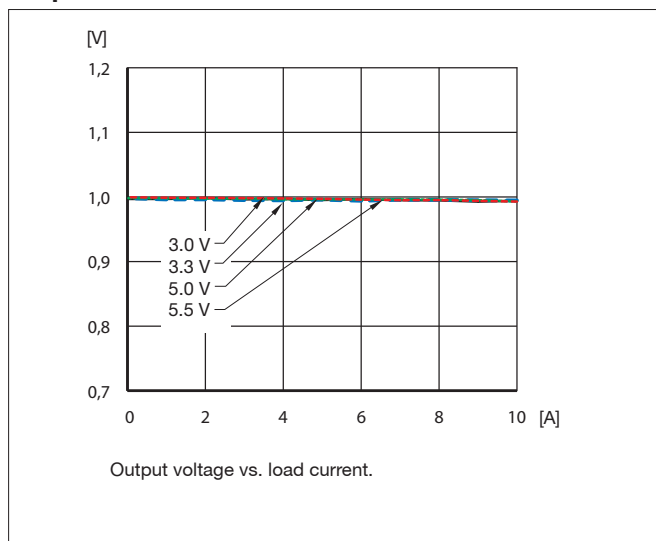

Start-Up

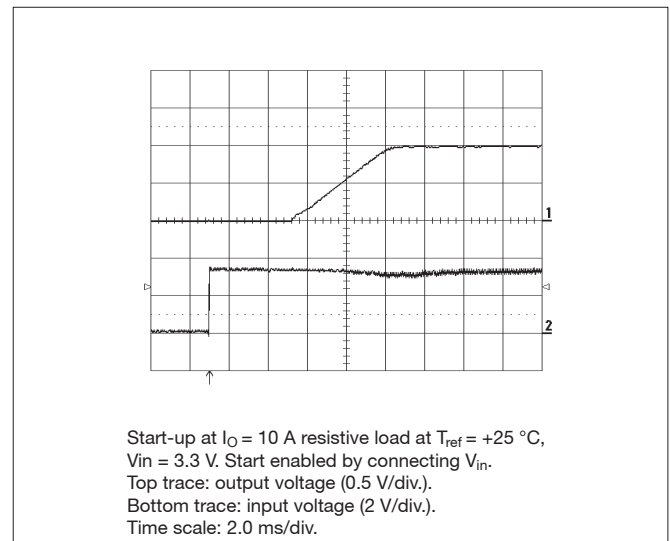

Adjusted to 1.0 V out - Typical Characteristics

General conditions: Input filter 2 x 22 μ F, Output filter 1 x 150 μ F

Turn Off

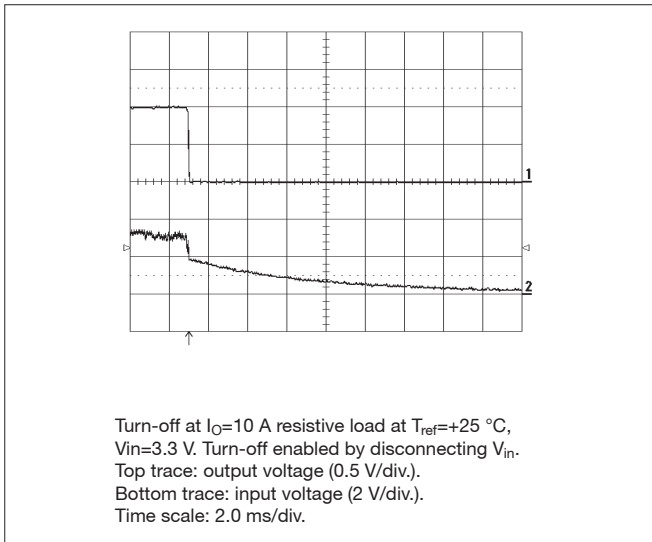

Output Ripple

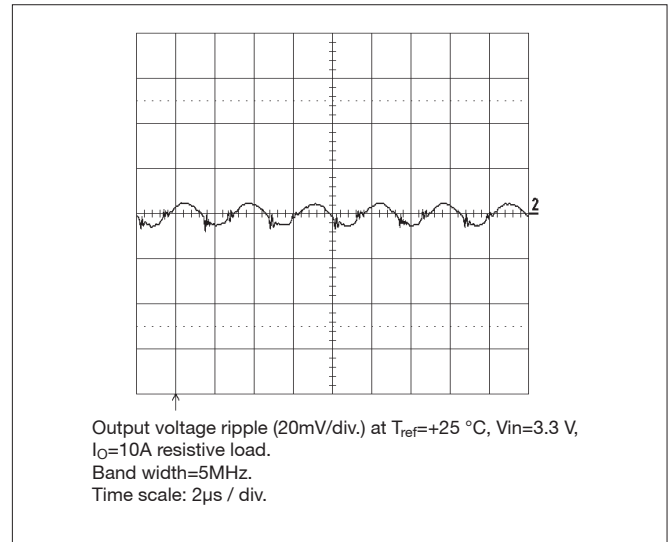

Transient with 150 μ F output capacitor

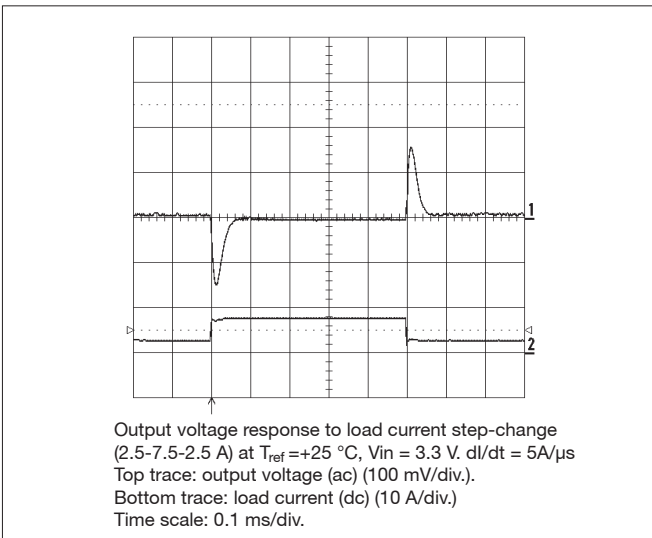

Transient with 300 μ F output capacitor

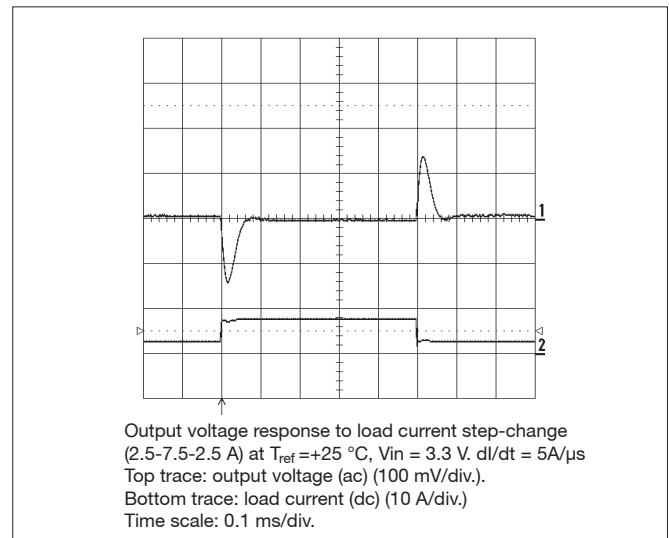

Adjusted to 1.2 V out - Data

$T_{ref} = -30 \dots +90 \text{ }^\circ\text{C}$, $V_I = 3.0 \dots 5.5 \text{ V}$ unless otherwise specified. Input filter $2 \times 22 \text{ } \mu\text{F}$, Output filter $1 \times 150 \text{ } \mu\text{F}$
 Typ values specified at: $T_{ref} = +25 \text{ }^\circ\text{C}$ and V_{Inom} , $I_{Omax} = 10 \text{ A}$. Note: +Sense connected to +Out

Characteristics		Conditions	Output			Unit
			min	typ	max	
V_{O1}	Output voltage adjusted setting	$T_{ref} = +25 \text{ }^\circ\text{C}$, V_{Inom} , I_{Omax} , $R_{adj} 42 \text{ k}\Omega$		1.20		V
V_O	Output voltage tolerance band	$I_O = 0.01 \dots 1.0 \times I_{Omax}$	1.164		1.236	V
	Idling voltage	$I_O = 0$	1.18		1.22	V
	Line regulation	$V_{Imin} \dots V_{Imax}$, I_{Omax}		11		mV
	Load regulation	$I_O = 0.01 \dots 1.0 \times I_{Omax}$, V_{Inom}		10		mV
V_{tr}	Load transient voltage deviation	Load step = $0.25 \dots 0.75 \times I_{Omax}$, $dI/dt = 5 \text{ A}/\mu\text{s}$, $C_O = 150 \text{ } \mu\text{F}$, $V_I = 3.3 \text{ V}$		140		mV
t_{tr}	Load transient recovery time			60		μs
T_{coeff}	Temperature coefficient	$T_{ref} = -30 \dots +90 \text{ }^\circ\text{C}$, I_{Omax}	-0.1	0	+0.1	$\text{mV}/^\circ\text{C}$
t_s	Start-up time	From V_I connected to $V_O = 0.9 \times V_{O1}$, $I_O = 0.1 \dots 1.0 \times I_{Omax}$, V_{Inom}		8.5		ms
t_r	Ramp-up time	$0.1 \dots 0.9 \times V_O$, $I_O = 0.1 \dots 1.0 \times I_{Omax}$, V_{Inom}		4		ms
t_f	Fall time, $V_O \times 0.1$	$I_O = I_{Omax}$, V_{Inom}		0.2		ms
t_f	Fall time, $V_O \times 0.1$	$I_O = 0 \text{ A}$, V_{Inom}		5		s
t_{RCoff}	RC shut-down time to $V_O \times 0.1$	$I_O = I_{Omax}$, V_{Inom}		0.2		ms
t_{RCOn}	RC start-up time to $V_O \times 0.9$	$I_O = I_{Omax}$, V_{Inom}		8		ms
t_{RC}	RC fall time, $V_O \times 0.1 \dots 0.9$	$I_O = 0 \text{ A}$, V_{Inom}		5		s
I_O	Output current		0		10	A
P_{Omax}	Max output power	At $V_O = V_{Onom}$	12			W
I_{lim}	Current limit threshold	$T_{ref} < T_{refmax}$	15	18	22	A
V_{Oac}	Output ripple	20 Hz ... 5 MHz, I_{Omax}		10	20	mV_{p-p}
η	Efficiency - 50% load	$I_O = 0.5 \times I_{Omax}$, $V_I = 5 \text{ V}$		89.2		%
η	Efficiency - 100% load	$I_O = I_{Omax}$, $V_I = 5 \text{ V}$	85	87.5		%
P_d	Power Dissipation	$I_O = I_{Omax}$, $V_I = 5 \text{ V}$		1.7	2.1	W
F_o	Switching frequency	$I_O = 0 \dots 1.0 \times I_{Omax}$	250	300	350	kHz
I_{sense}	Remote sense current				8	mA
I_I	Static input current	$V_I = 3.0 \text{ V}$, $I_O = I_{Omax}$, $T_{ref} = 25 \text{ }^\circ\text{C}$		4.6		A
MTBF	Predicted reliability	$T_{ref} = 40 \text{ }^\circ\text{C}$		6		million hours

Adjusted to 1.2 V - Typical Characteristics

General conditions: Input filter 2 x 22 μ F, Output filter 1 x 150 μ F

Efficiency

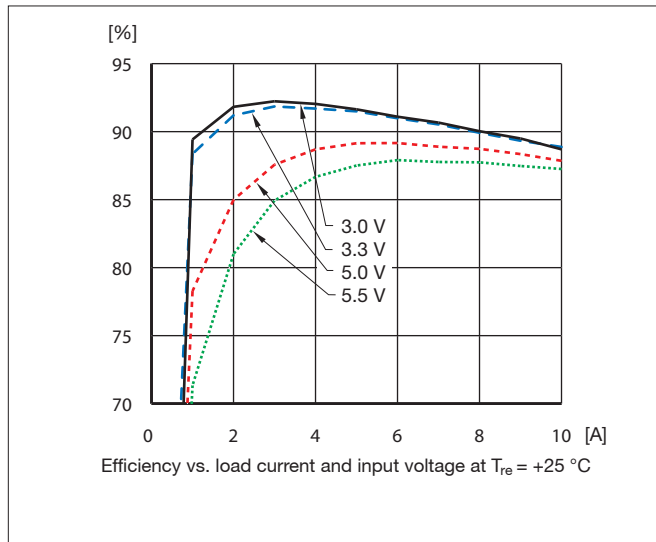

Power Dissipation

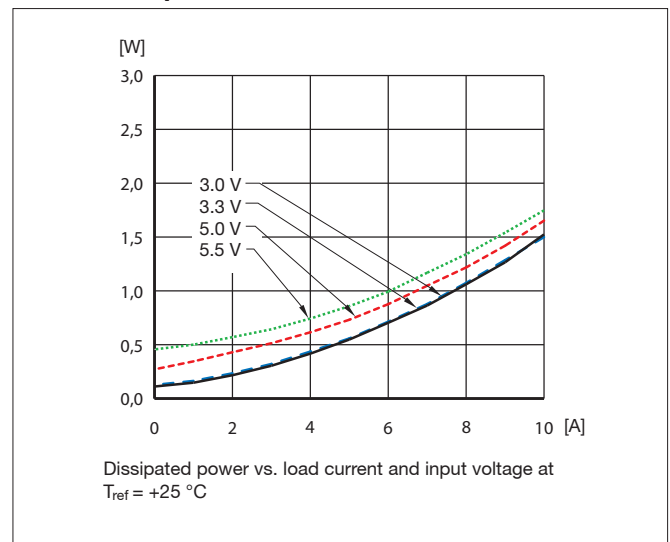

Output Current Derating at 3.3 V input

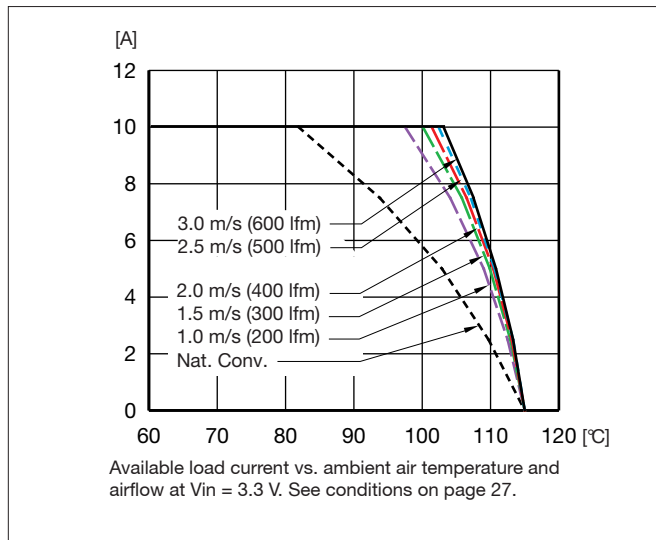

Output Current Derating at 5 V input

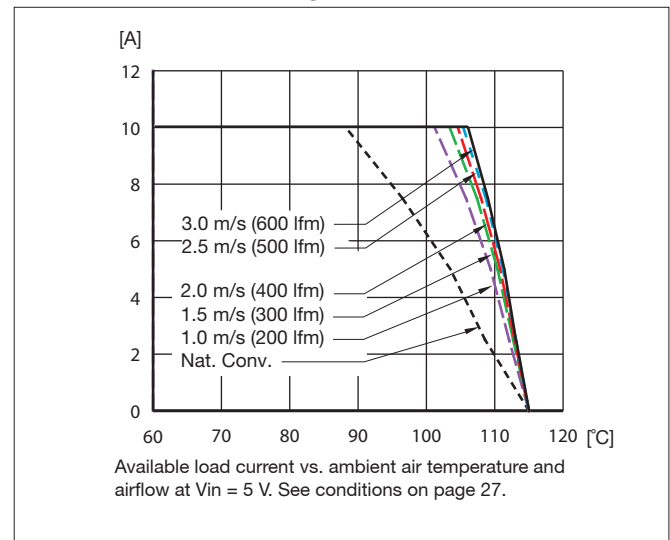

Output Characteristic

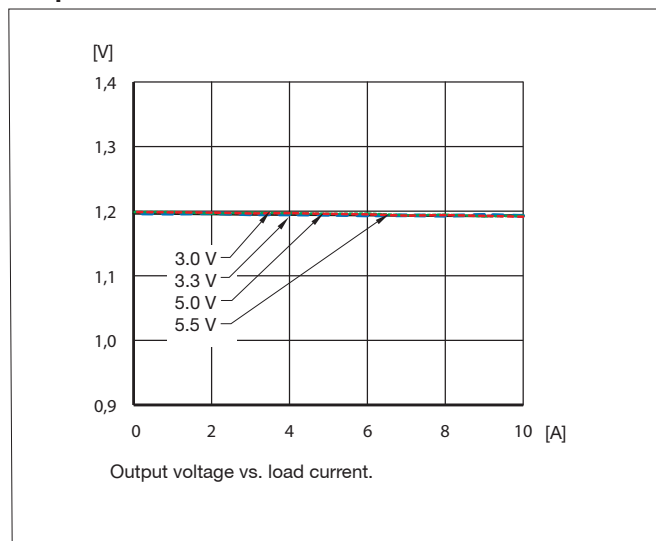

Start-Up

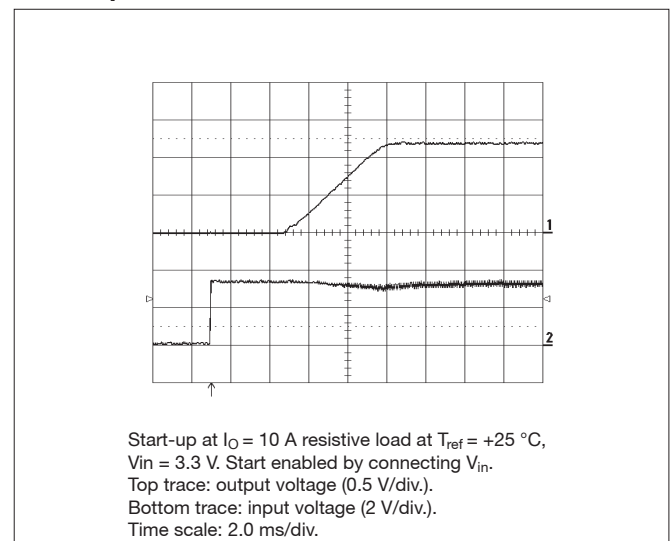

Adjusted to 1.2 V - Typical Characteristics

General conditions: Input filter 2 x 22 μ F, Output filter 1 x 150 μ F

Turn Off

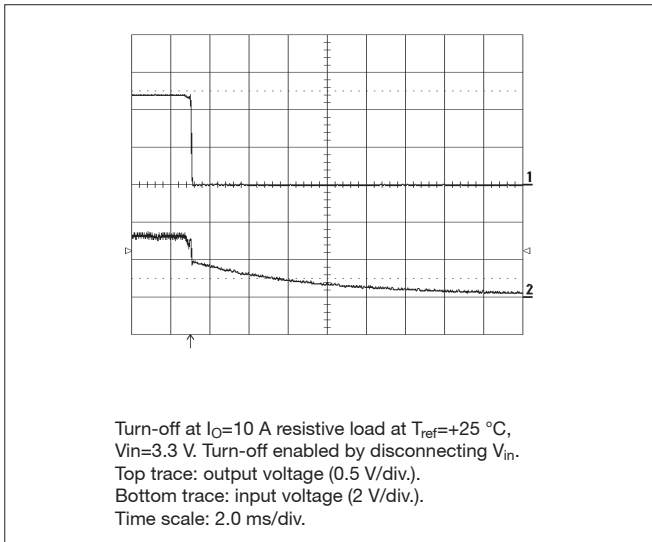

Output Ripple

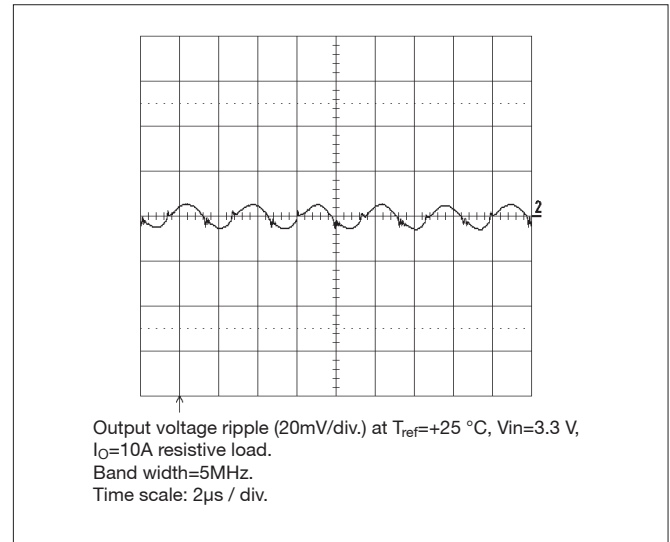

Transient with 150 μ F output capacitor

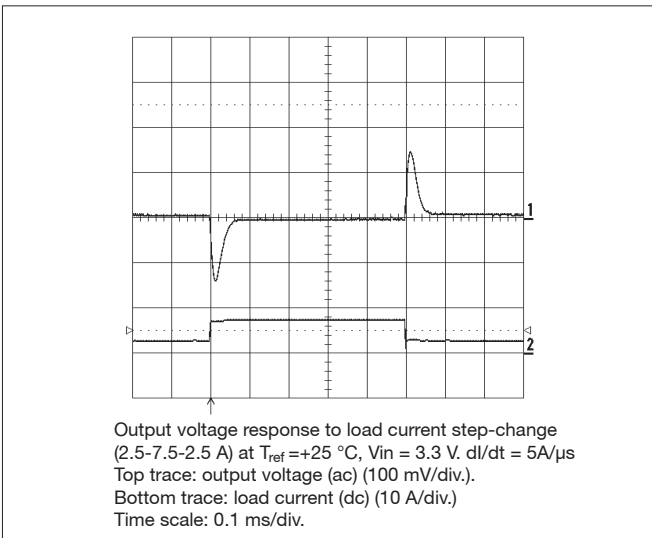

Transient with 300 μ F output capacitor

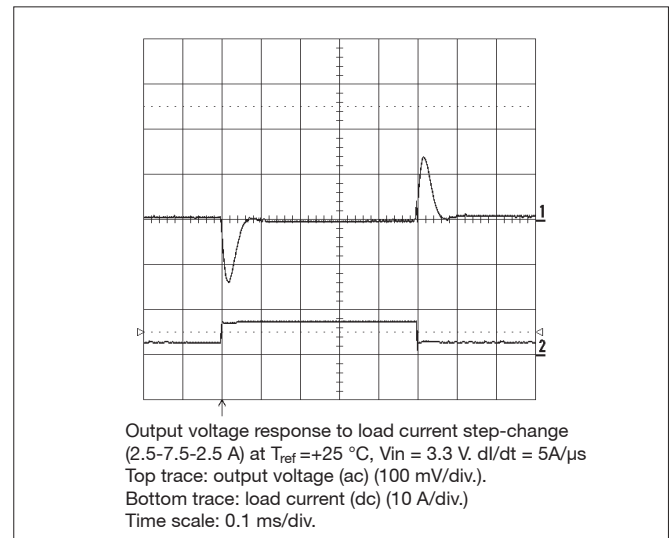

Adjusted to 1.5 V out - Data

$T_{ref} = -30 \dots +90 \text{ }^\circ\text{C}$, $V_I = 3.0 \dots 5.5 \text{ V}$ unless otherwise specified. Input filter $2 \times 22 \text{ } \mu\text{F}$, Output filter $1 \times 150 \text{ } \mu\text{F}$
Typ values specified at: $T_{ref} = +25 \text{ }^\circ\text{C}$ and V_{Inom} . $I_{Omax} = 10 \text{ A}$. Note: +Sense connected to +Out

Characteristics		Conditions	Output			Unit
			min	typ	max	
V_{O1}	Output voltage adjusted setting	$T_{ref} = +25 \text{ }^\circ\text{C}$, V_{Inom} , I_{Omax} , $R_{adj} 23 \text{ k}\Omega$		1.5		V
V_O	Output voltage tolerance band	$I_O = 0.01 \dots 1.0 \times I_{Omax}$	1.445		1.545	V
	Idling voltage	$I_O = 0$	1.48		1.52	V
	Line regulation	$V_{Imin} \dots V_{Imax}$, I_{Omax}		11		mV
	Load regulation	$I_O = 0.01 \dots 1.0 \times I_{Omax}$, V_{Inom}		10		mV
V_{tr}	Load transient voltage deviation	Load step = $0.25 \dots 0.75 \times I_{Omax}$, $di/dt = 5 \text{ A}/\mu\text{s}$, $C_O = 150 \text{ } \mu\text{F}$, $V_I = 3.3 \text{ V}$		100		mV
t_{tr}	Load transient recovery time			60		μs
T_{coeff}	Temperature coefficient	$T_{ref} = -30 \dots +90 \text{ }^\circ\text{C}$, I_{Omax}	-0.1	0	+0.1	mV/ $^\circ\text{C}$
t_s	Start-up time	From V_I connected to $V_O = 0.9 \times V_{O1}$, $I_O = 0.1 \dots 1.0 \times I_{Omax}$, V_{Inom}		8.5		ms
t_r	Ramp-up time	$0.1 \dots 0.9 \times V_O$, $I_O = 0.1 \dots 1.0 \times I_{Omax}$, V_{Inom}		4		ms
t_f	Fall time, $V_O \times 0.1$	$I_O = I_{Omax}$, V_{Inom}		0.2		ms
t_f	Fall time, $V_O \times 0.1$	$I_O = 0 \text{ A}$, V_{Inom}		5		s
t_{RCoff}	RC shut-down time to $V_O \times 0.1$	$I_O = I_{Omax}$, V_{Inom}		0.2		ms
t_{RCOn}	RC start-up time to $V_O \times 0.9$	$I_O = I_{Omax}$, V_{Inom}		8		ms
t_{RC}	RC fall time, $V_O \times 0.1 \dots 0.9$	$I_O = 0 \text{ A}$, V_{Inom}		5		s
I_O	Output current		0		10	A
P_{Omax}	Max output power	At $V_O = V_{Onom}$	15			W
I_{lim}	Current limit threshold	$T_{ref} < T_{refmax}$	15	18	22	A
V_{Oac}	Output ripple	20Hz ... 5MHz, I_{Omax}		15	25	mV _{p-p}
η	Efficiency - 50% load	$I_O = 0.5 \times I_{Omax}$, $V_I = 5 \text{ V}$		90		%
η	Efficiency - 100% load	$I_O = I_{Omax}$, $V_I = 5 \text{ V}$	87	89.5		%
P_d	Power Dissipation	$I_O = I_{Omax}$, $V_I = 5 \text{ V}$		1.8	2.3	W
F_o	Switching frequency	$I_O = 0 \dots 1.0 \times I_{Omax}$	250	300	350	kHz
I_{sense}	Remote sense current				8	mA
I_I	Static input current	$V_I = 3.0 \text{ V}$, $I_O = I_{Omax}$, $T_{ref} = 25 \text{ }^\circ\text{C}$		6		A
MTBF	Predicted reliability	$T_{ref} = 40 \text{ }^\circ\text{C}$		6		million hours

Adjusted to 1.5V out - Typical Characteristics

General conditions: Input filter 2 x 22 μ F, Output filter 1 x 150 μ F

Efficiency

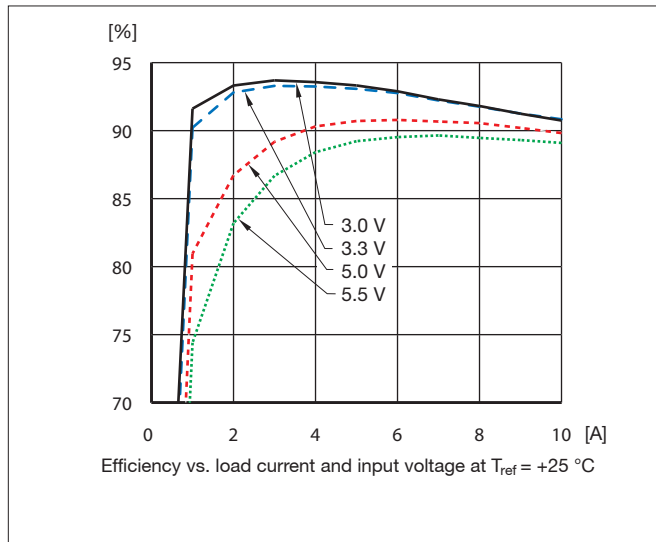

Power Dissipation

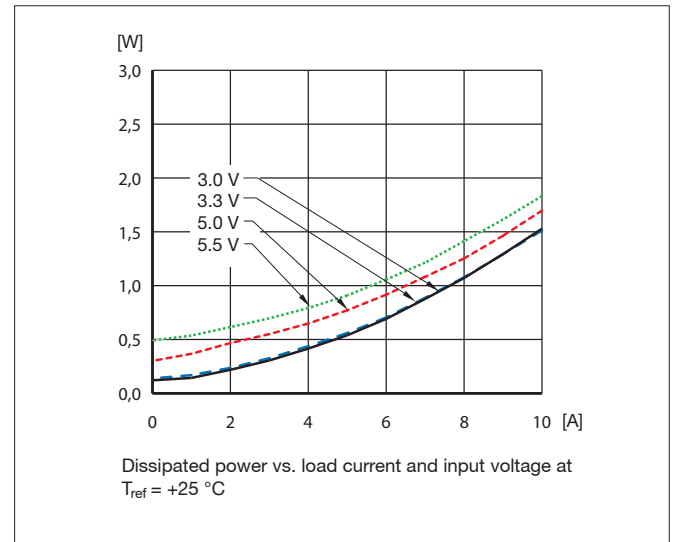

Output Current Derating at 3.3 V input

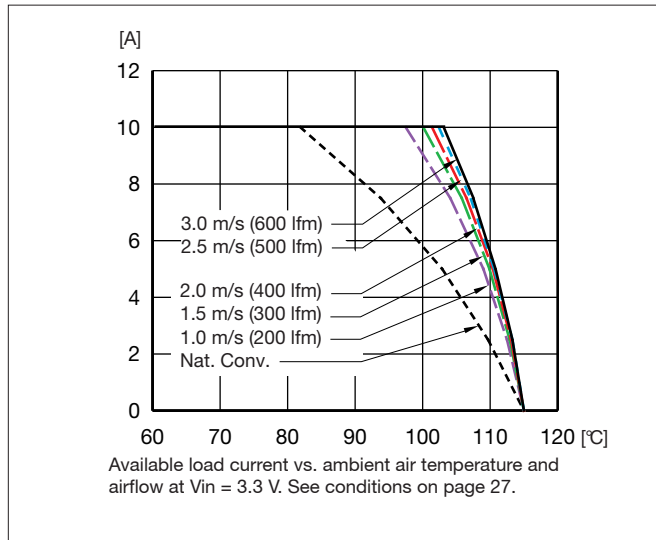

Output Current Derating at 5 V input

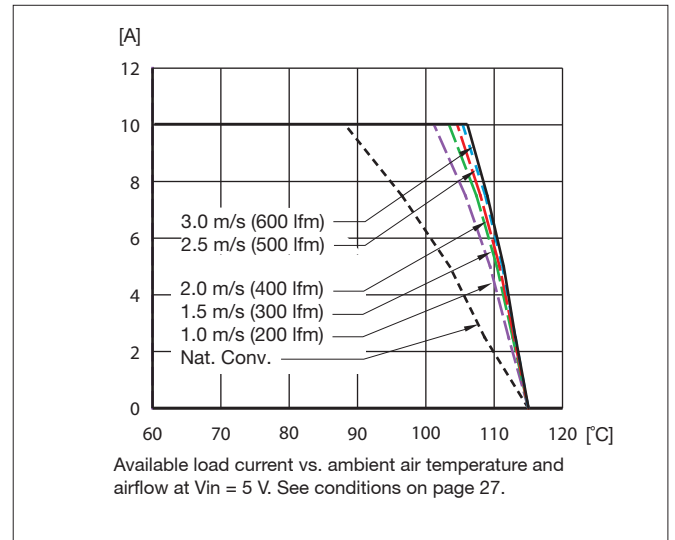

Output Characteristic

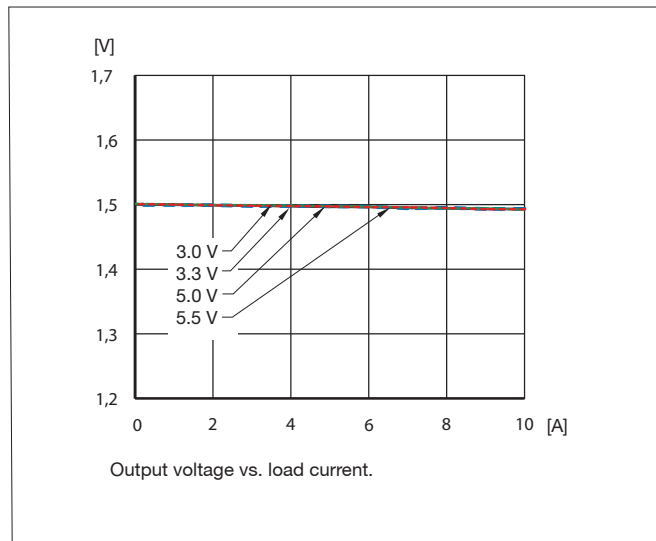

Start-Up

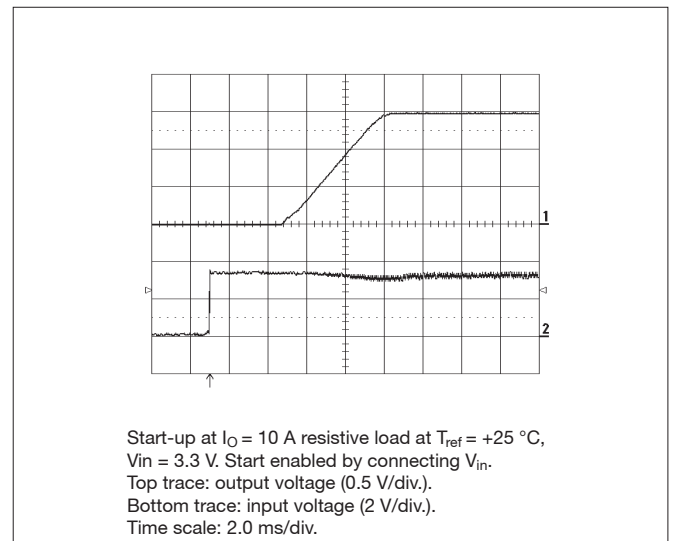

Adjusted to 1.5V out - Typical Characteristics

General conditions: Input filter 2 x 22 μ F, Output filter 1 x 150 μ F

Turn Off

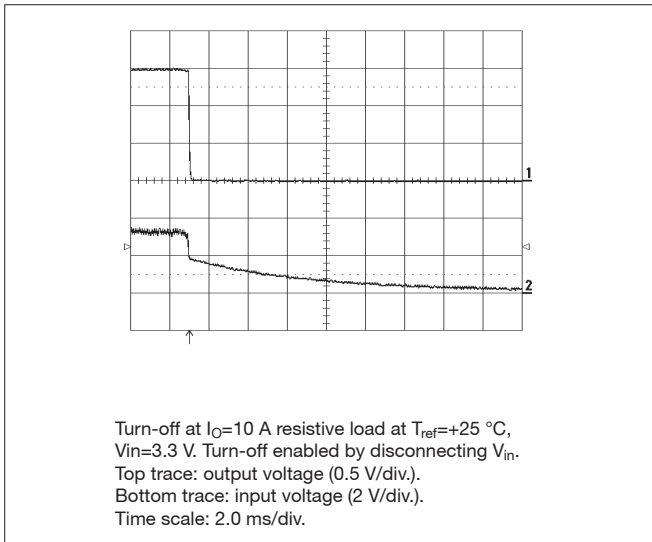

Output Ripple

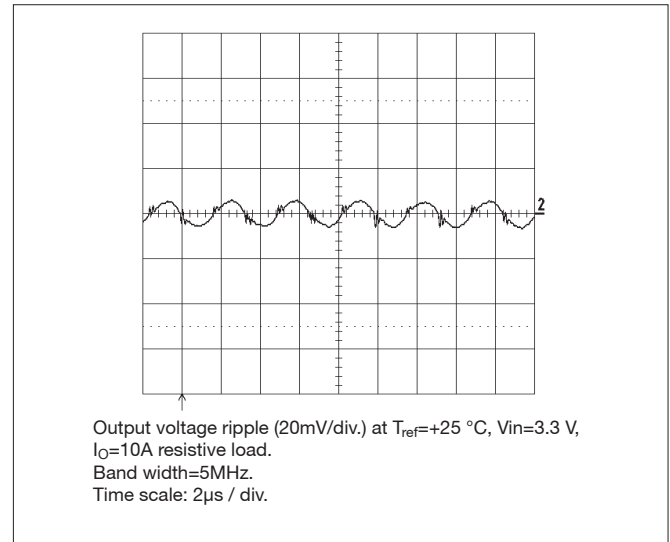

Transient with 150 μ F output capacitor

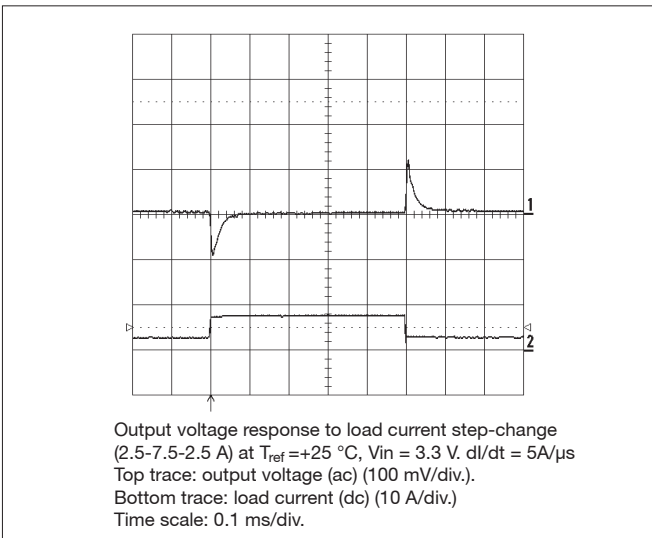

Transient with 300 μ F output capacitor

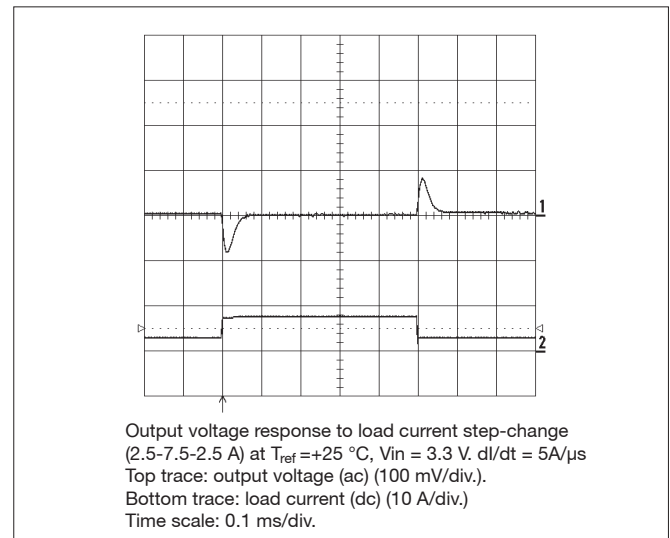

Adjusted to 1.8 V out - Data

$T_{ref} = -30 \dots +90 \text{ }^\circ\text{C}$, $V_I = 3.0 \dots 5.5 \text{ V}$ unless otherwise specified. Input filter $2 \times 22 \text{ } \mu\text{F}$, Output filter $1 \times 150 \text{ } \mu\text{F}$
Typ values specified at: $T_{ref} = +25 \text{ }^\circ\text{C}$ and V_{Inom} . $I_{Omax} = 10 \text{ A}$. Note: +Sense connected to +Out

Characteristics		Conditions	Output			Unit
			min	typ	max	
V_{O1}	Output voltage adjusted setting	$T_{ref} = +25 \text{ }^\circ\text{C}$, V_{Inom} , I_{Omax} , $R_{adj} 15 \text{ k}\Omega$		1.80		V
V_O	Output voltage tolerance band	$I_O = 0.01 \dots 1.0 \times I_{Omax}$	1.746		1.854	V
	Idling voltage	$I_O = 0$	1.78		1.82	V
	Line regulation	$V_{Imin} \dots V_{Imax}$, I_{Omax}		11		mV
	Load regulation	$I_O = 0.01 \dots 1.0 \times I_{Omax}$, V_{Inom}		10		mV
V_{tr}	Load transient voltage deviation	Load step = $0.25 \dots 0.75 \times I_{Omax}$, $di/dt = 5 \text{ A}/\mu\text{s}$, $C_O = 150 \text{ } \mu\text{F}$, $V_I = 3.3 \text{ V}$		120		mV
t_{tr}	Load transient recovery time			60		μs
T_{coeff}	Temperature coefficient	$T_{ref} = -30 \dots +90 \text{ }^\circ\text{C}$, I_{Omax}	-0.1	0	+0.1	mV/ $^\circ\text{C}$
t_s	Start-up time	From V_I connected to $V_O = 0.9 \times V_{O1}$, $I_O = 0.1 \dots 1.0 \times I_{Omax}$, V_{Inom}		8.5		ms
t_r	Ramp-up time	$0.1 \dots 0.9 \times V_O$, $I_O = 0.1 \dots 1.0 \times I_{Omax}$, V_{Inom}		4		ms
t_f	Fall time, $V_O \times 0.1$	$I_O = I_{Omax}$, V_{Inom}		0.2		ms
t_f	Fall time, $V_O \times 0.1$	$I_O = 0 \text{ A}$, V_{Inom}		5		s
t_{RCoff}	RC shut-down time to $V_O \times 0.1$	$I_O = I_{Omax}$, V_{Inom}		0.2		ms
t_{RCOn}	RC start-up time to $V_O \times 0.9$	$I_O = I_{Omax}$, V_{Inom}		8		ms
t_{RC}	RC fall time, $V_O \times 0.1 \dots 0.9$	$I_O = 0 \text{ A}$, V_{Inom}		5		s
I_O	Output current		0		10	A
P_{Omax}	Max output power	At $V_O = V_{Onom}$	18			W
I_{lim}	Current limit threshold	$T_{ref} < T_{refmax}$	15	18	22	A
V_{Oac}	Output ripple	20 Hz ... 5 MHz, I_{Omax}		15	25	mV _{p-p}
η	Efficiency - 50% load	$I_O = 0.5 \times I_{Omax}$, $V_I = 5 \text{ V}$		91		%
η	Efficiency - 100% load	$I_O = I_{Omax}$, $V_I = 5 \text{ V}$	89.5	91.1		%
P_d	Power Dissipation	$I_O = I_{Omax}$, $V_I = 5 \text{ V}$		1.8	2.2	W
F_o	Switching frequency	$I_O = 0 \dots 1.0 \times I_{Omax}$	250	300	350	kHz
I_{sense}	Remote sense current				8	mA
I_i	Static input current	$V_I = 3.0 \text{ V}$, $I_O = I_{Omax}$, $T_{ref} = 25 \text{ }^\circ\text{C}$		6.6		A
MTBF	Predicted reliability	$T_{ref} = 40 \text{ }^\circ\text{C}$		6		million hours

Adjusted to 1.8 V - Typical Characteristics

General conditions: Input filter 2 x 22 μ F, Output filter 1 x 150 μ F

Efficiency

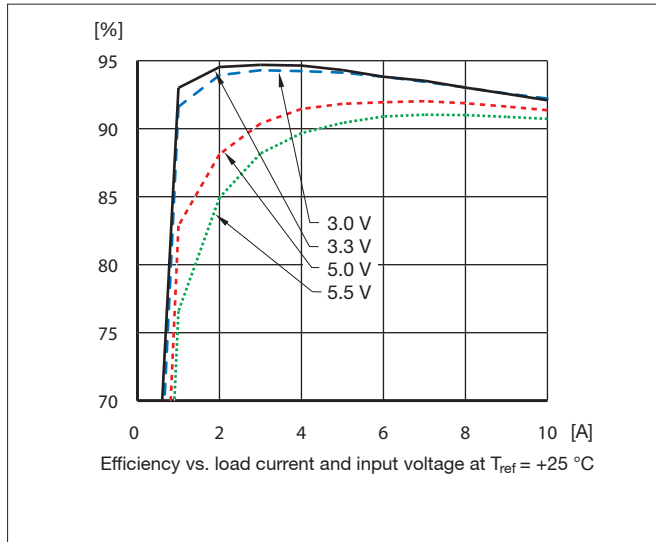

Power Dissipation

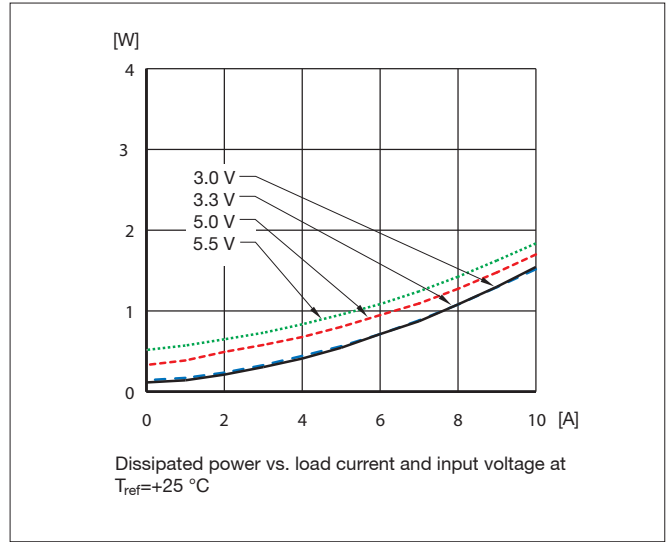

Output Current Derating at 3.3 V input

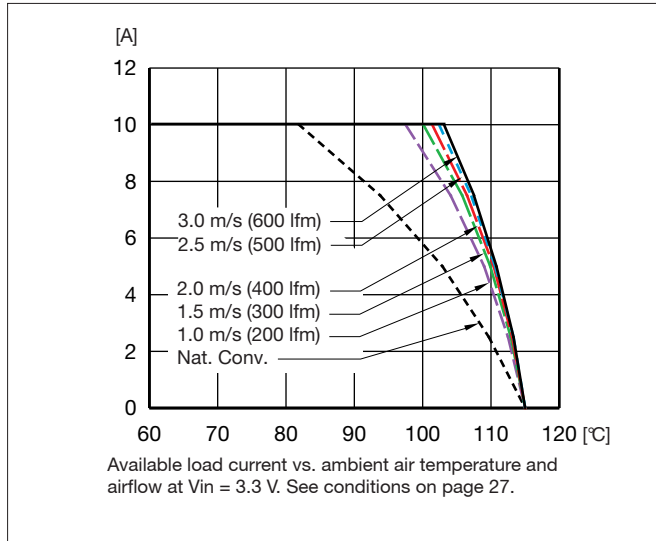

Output Current Derating at 5 V input

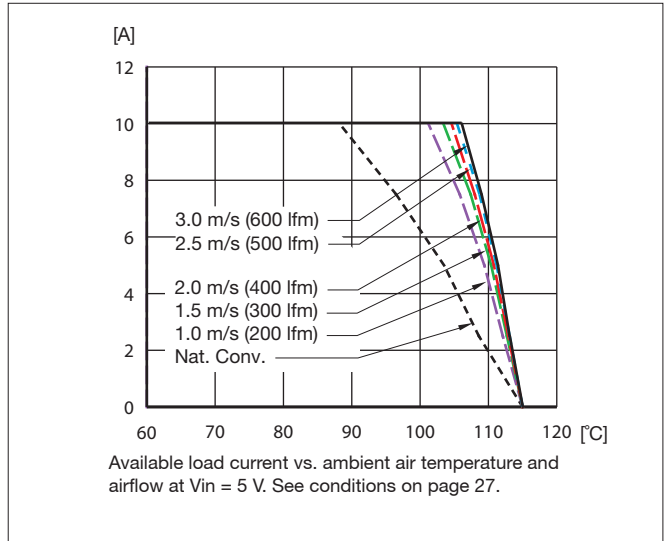

Output Characteristic

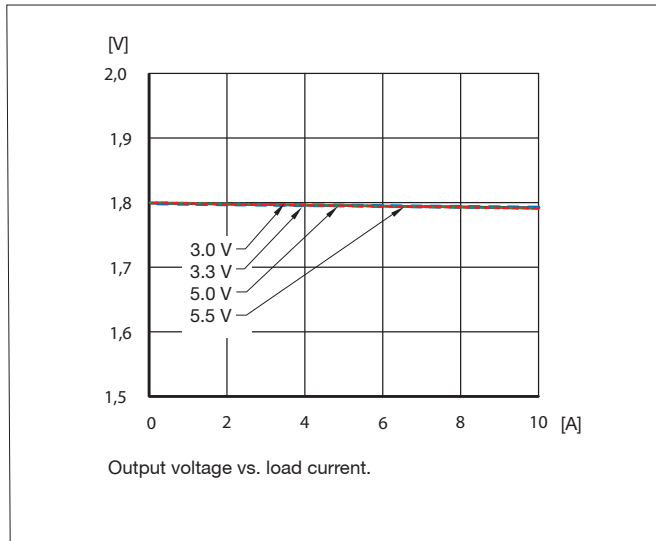

Start-Up

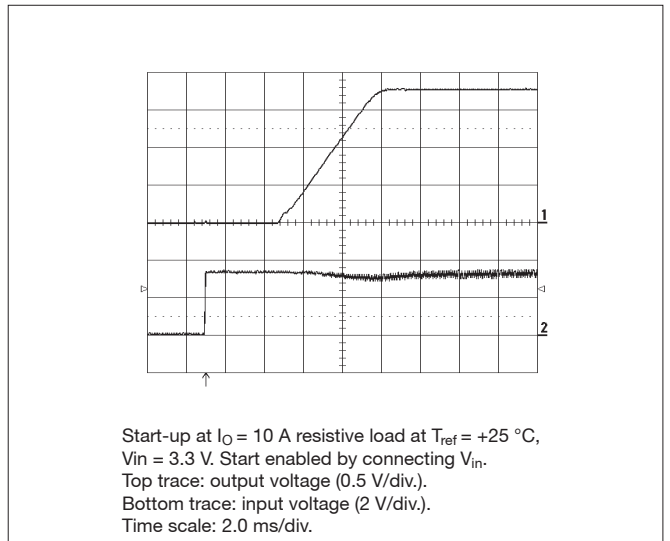

Adjusted to 1.8 V out - Typical Characteristics

General conditions: Input filter 2 x 22 μ F, Output filter 1 x 150 μ F

Turn Off

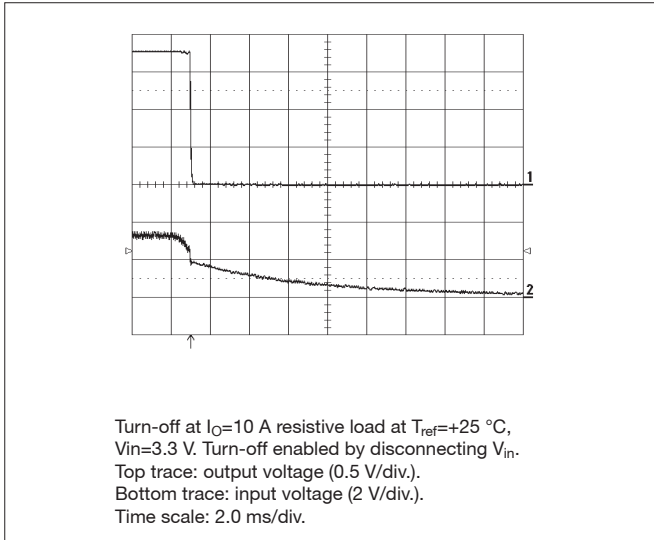

Output Ripple

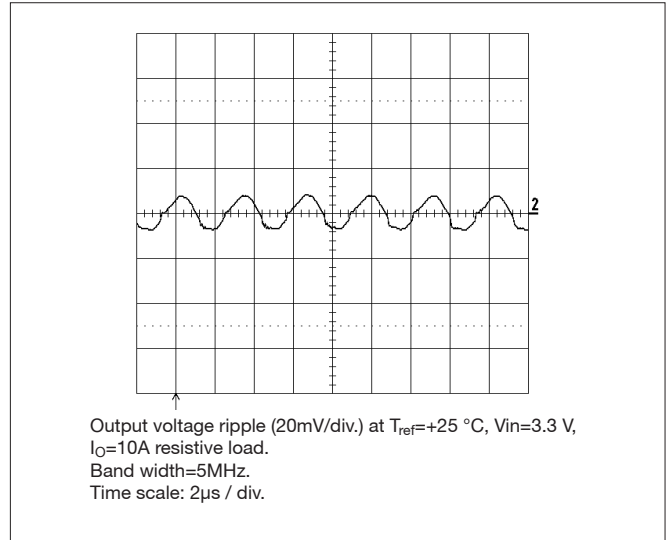

Transient with 150 μ F output capacitor

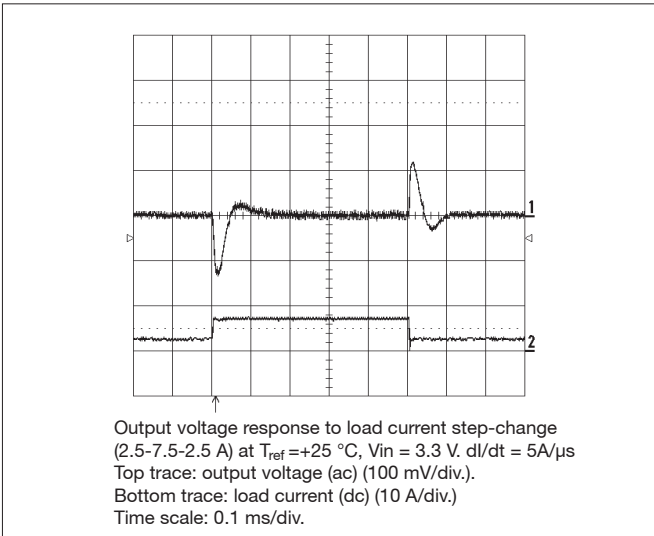

Transient with 300 μ F output capacitor

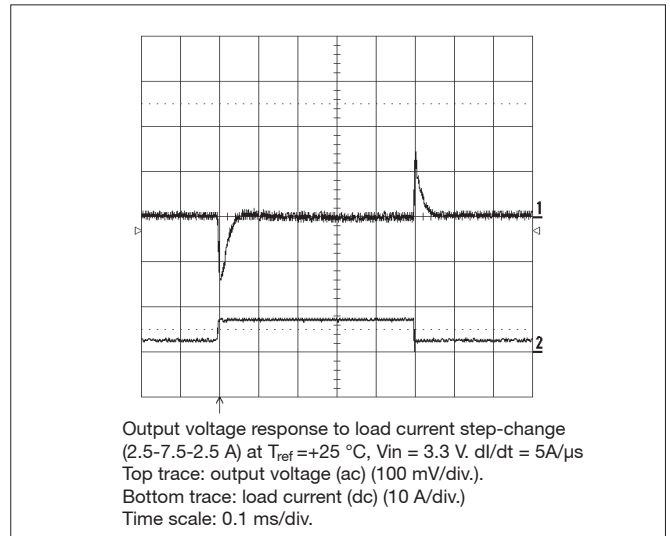

Adjusted to 2.5 V out - Data

$T_{ref} = -30 \dots +90 \text{ }^\circ\text{C}$, $V_I = 3.0 \dots 5.5 \text{ V}$ unless otherwise specified. Input filter $2 \times 22 \text{ } \mu\text{F}$, Output filter $1 \times 150 \text{ } \mu\text{F}$
 Typ values specified at: $T_{ref} = +25 \text{ }^\circ\text{C}$ and V_{Inom} , $I_{Omax} = 10 \text{ A}$. Note: +Sense connected to +Out

Characteristics		Conditions	Output			Unit
			min	typ	max	
V_{O1}	Output voltage adjusted setting	$T_{ref} = +25 \text{ }^\circ\text{C}$, V_{Inom} , I_{Omax} , $R_{adj} 7 \text{ k}\Omega$		2.5		V
V_O	Output voltage tolerance band	$I_O = 0.01 \dots 1.0 \times I_{Omax}$	2.425		2.575	V
	Idling voltage	$I_O = 0$	2.48		2.52	V
	Line regulation	$V_{Imin} \dots V_{Imax}$, I_{Omax}		11		mV
	Load regulation	$I_O = 0.01 \dots 1.0 \times I_{Omax}$, V_{Inom}		10		mV
V_{tr}	Load transient voltage deviation	Load step = $0.25 \dots 0.75 \times I_{Omax}$, $dl/dt = 5 \text{ A}/\mu\text{s}$, $C_O = 150 \text{ } \mu\text{F}$, $V_I = 3.3 \text{ V}$		120		mV
t_{tr}	Load transient recovery time			60		μs
T_{coeff}	Temperature coefficient	$T_{ref} = -30 \dots +90 \text{ }^\circ\text{C}$, I_{Omax}	-0.1	0	+0.1	mV/ $^\circ\text{C}$
t_s	Start-up time	From V_I connected to $V_O = 0.9 \times V_{O1}$, $I_O = 0.1 \dots 1.0 \times I_{Omax}$, V_{Inom}		8.5		ms
t_r	Ramp-up time	$0.1 \dots 0.9 \times V_O$, $I_O = 0.1 \dots 1.0 \times I_{Omax}$, V_{Inom}		4		ms
t_f	Fall time, $V_O \times 0.1$	$I_O = I_{Omax}$, V_{Inom}		0.2		ms
t_f	Fall time, $V_O \times 0.1$	$I_O = 0 \text{ A}$, V_{Inom}		5		s
t_{RCoff}	RC shut-down time to $V_O \times 0.1$	$I_O = I_{Omax}$, V_{Inom}		0.2		ms
t_{RCOn}	RC start-up time to $V_O \times 0.9$	$I_O = I_{Omax}$, V_{Inom}		8		ms
t_{RC}	RC fall time, $V_O \times 0.1 \dots 0.9$	$I_O = 0 \text{ A}$, V_{Inom}		5		s
I_O	Output current		0		10	A
P_{Omax}	Max output power	At $V_O = V_{Onom}$	25			W
I_{lim}	Current limit threshold	$T_{ref} < T_{refmax}$	15	18	22	A
V_{Oac}	Output ripple	20 Hz ... 5 MHz, I_{Omax}		20	30	mV _{p-p}
η	Efficiency - 50% load	$I_O = 0.5 \times I_{Omax}$, $V_I = 5 \text{ V}$		93.8		%
η	Efficiency - 100% load	$I_O = I_{Omax}$, $V_I = 5 \text{ V}$	92	93.5		%
P_d	Power Dissipation	$I_O = I_{Omax}$, $V_I = 5 \text{ V}$		1.8	2.3	W
F_o	Switching frequency	$I_O = 0 \dots 1.0 \times I_{Omax}$	250	300	350	kHz
I_{sense}	Remote sense current				8	mA
I_I	Static input current	$V_I = 3.0 \text{ V}$, $I_O = I_{Omax}$, $T_{ref} = 25 \text{ }^\circ\text{C}$		9.0		A
MTBF	Predicted reliability	$T_{ref} = 40 \text{ }^\circ\text{C}$		6		million hours

Adjusted to 2.5 V out - Typical Characteristics

General conditions: Input filter 2 x 22 μ F, Output filter 1 x 150 μ F

Efficiency

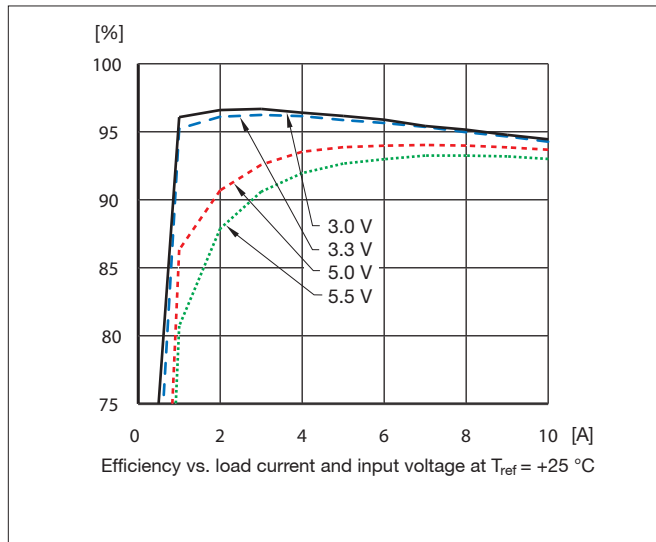

Power Dissipation

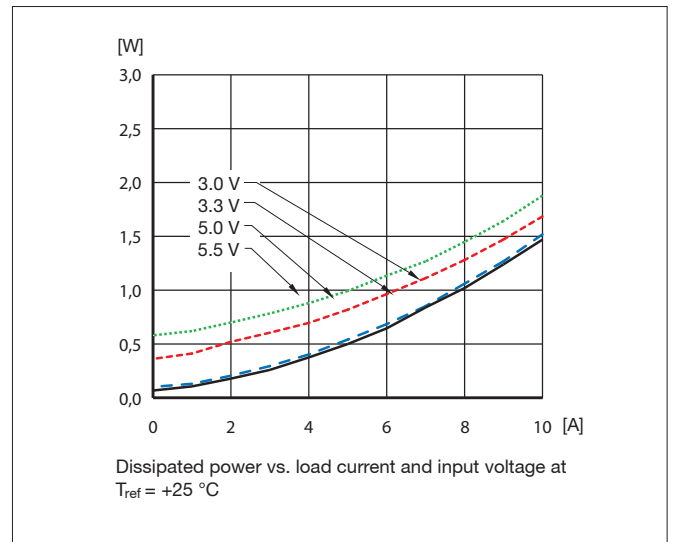

Output Current Derating at 3.3 V input

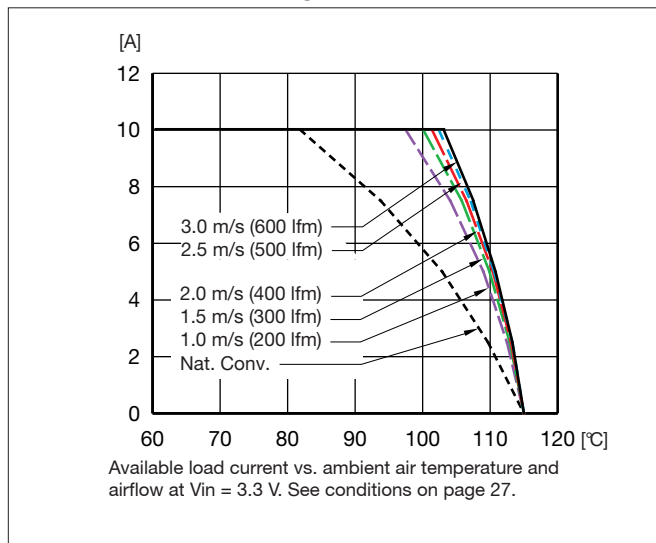

Output Current Derating at 5 V input

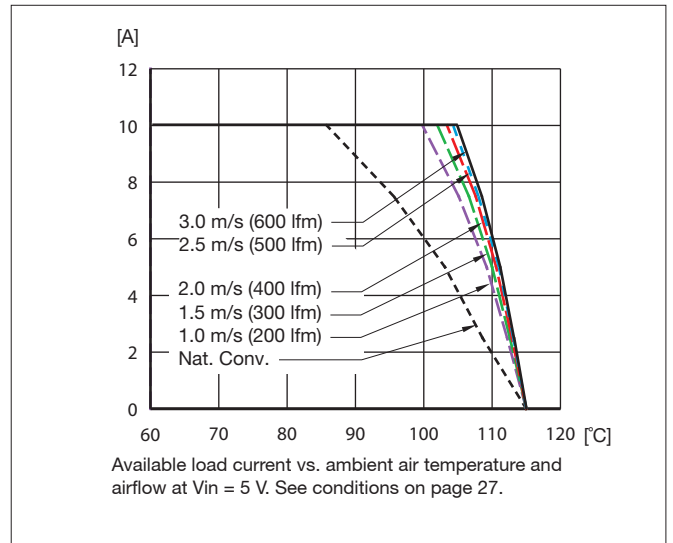

Output Characteristic

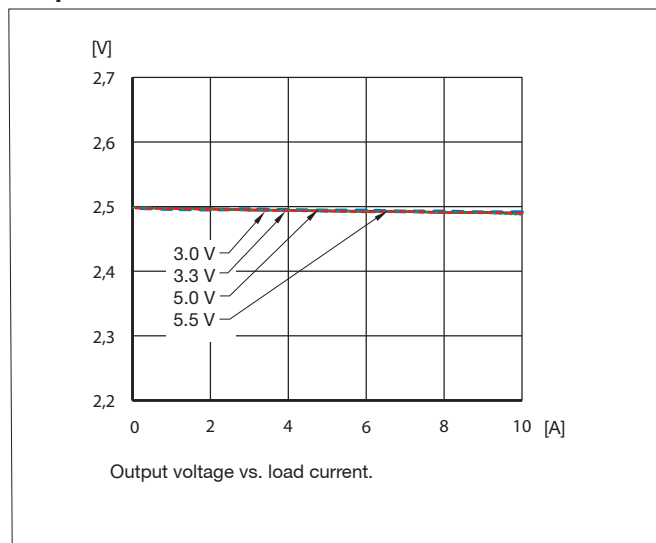

Start-Up

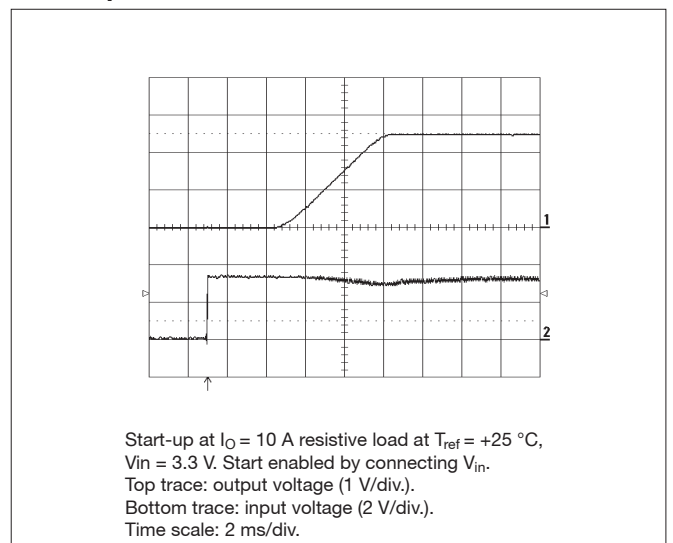

Adjusted to 2.5 V out - Typical Characteristics

General conditions: Input filter 2 x 22 μ F, Output filter 1 x 150 μ F

Turn Off

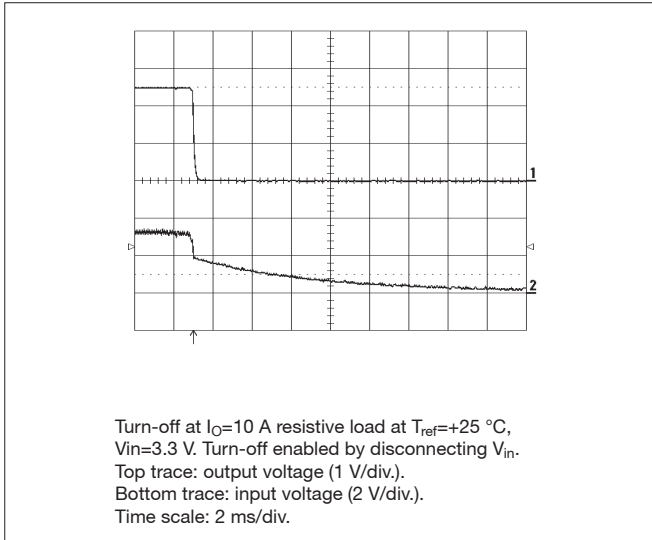

Output Ripple

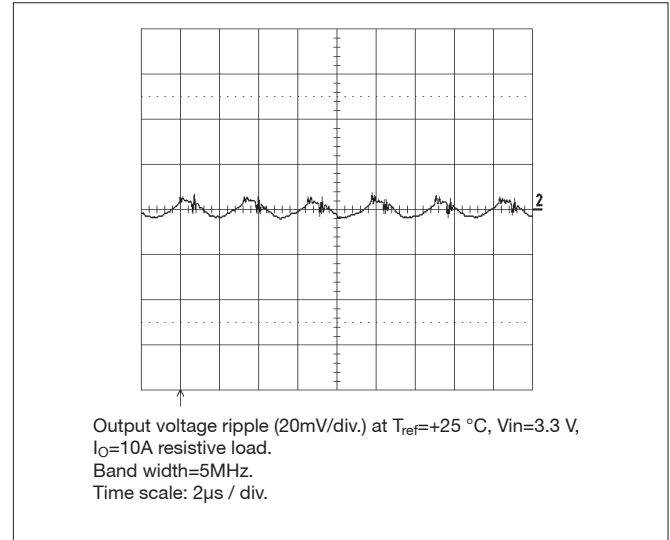

Transient with 150 μ F output capacitor

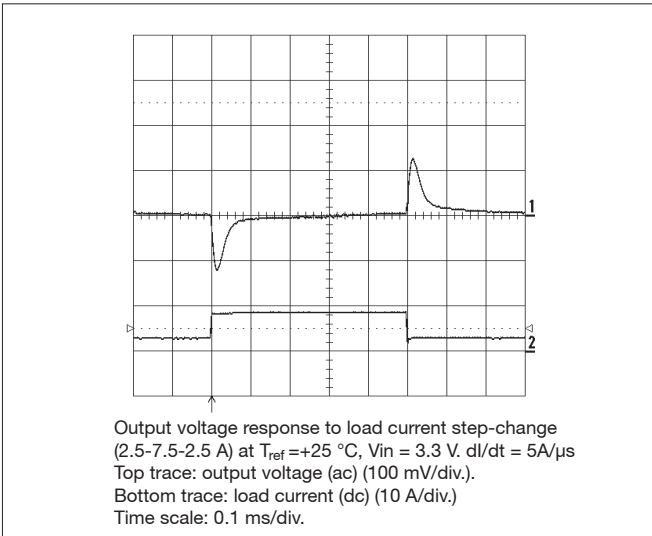

Transient with 300 μ F output capacitor

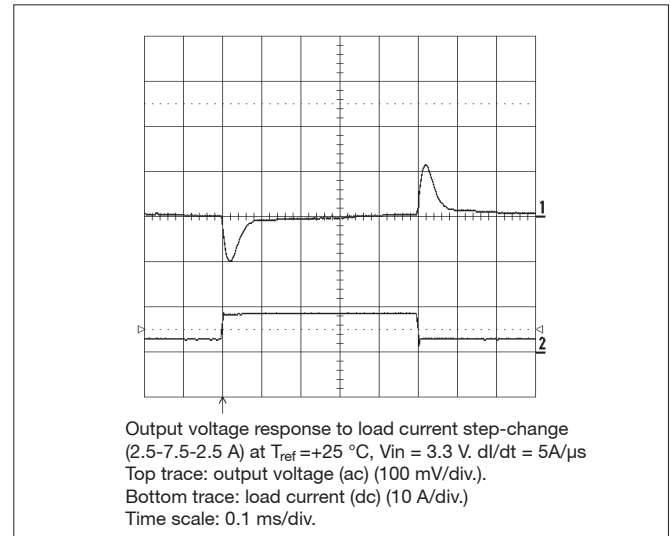

Adjusted to 3.3 V out - Data

$T_{ref} = -30 \dots +90 \text{ }^\circ\text{C}$, $V_I = 3.8 \dots 5.5 \text{ V}$ unless otherwise specified. Input filter $2 \times 22 \text{ } \mu\text{F}$, Output filter $1 \times 150 \text{ } \mu\text{F}$
Typ values specified at: $T_{ref} = +25 \text{ }^\circ\text{C}$ and $V_I = 5.0 \text{ V}$. $I_{Omax} = 10 \text{ A}$. Note: +Sense connected to +Out

Characteristics		Conditions	Output			Unit
			min	typ	max	
V_{O1}	Output voltage adjusted setting	$T_{ref} = +25 \text{ }^\circ\text{C}$, $V_I > 3.8 \text{ V}$, I_{Omax} , $R_{adj} 3.1 \text{ k}\Omega$		3.3		V
V_O	Output voltage tolerance band	$I_O = 0.1 \dots 1.0 \times I_{Omax}$	3.201		3.399	V
	Idling voltage	$I_O = 0$	3.28		3.32	V
	Line regulation	$V_I = 5 \text{ V} \dots V_{Imax}$, I_{Omax}		11		mV
	Load regulation	$I_O = 0.01 \dots 1.0 \times I_{Omax}$, $V_I = 5 \text{ V}$		10		mV
V_{tr}	Load transient voltage deviation	Load step = $0.25 \dots 0.75 \times I_{Omax}$, $dI/dt = 5 \text{ A}/\mu\text{s}$, $C_O = 150 \text{ } \mu\text{F}$, $V_I = 5 \text{ V}$		120		mV
t_{tr}	Load transient recovery time			60		μs
T_{coeff}	Temperature coefficient	$T_{ref} = -30 \dots +90 \text{ }^\circ\text{C}$, I_{Omax}	-0.1	0	+0.1	$\text{mV}/^\circ\text{C}$
t_s	Start-up time	From V_I connected to $V_O = 0.9 \times V_{Oadj}$, $I_O = 0.1 \dots 1.0 \times I_{Omax}$, $V_I = 5 \text{ V}$		8.5		ms
t_r	Ramp-up time	$0.1 \dots 0.9 \times V_O$, $I_O = 0.1 \dots 1.0 \times I_{Omax}$, $V_I = 5 \text{ V}$		4		ms
t_f	Fall time, $V_O \times 0.1$	$I_O = I_{Omax}$, $V_I = 5 \text{ V}$		0.2		ms
t_f	Fall time, $V_O \times 0.1$	$I_O = 0 \text{ A}$, $V_I = 5 \text{ V}$		5		s
t_{RCoff}	RC shut-down time to $V_O \times 0.1$	$I_O = I_{Omax}$, $V_I = 5 \text{ V}$		0.2		ms
t_{RCOn}	RC start-up time to $V_O \times 0.9$	$I_O = I_{Omax}$, $V_I = 5 \text{ V}$		8		ms
t_{RC}	RC fall time, $V_O \times 0.1 \dots 0.9$	$I_O = 0 \text{ A}$, $V_I = 5 \text{ V}$		5		s
I_O	Output current		0		10	A
P_{Omax}	Max output power	At $V_O = V_{Onom}$	33			W
I_{lim}	Current limit threshold	$T_{ref} < T_{refmax}$	15	18	22	A
V_{Oac}	Output ripple	20 Hz ... 5 MHz, I_{Omax}		20	30	mV_{p-p}
η	Efficiency - 50% load	$I_O = 0.5 \times I_{Omax}$, $V_I = 5 \text{ V}$		95.5		%
η	Efficiency - 100% load	$I_O = I_{Omax}$, $V_I = 5 \text{ V}$	93.5	95.0		%
P_d	Power Dissipation	$I_O = I_{Omax}$, $V_I = 5 \text{ V}$		1.8	2.3	W
F_o	Switching frequency	$I_O = 0 \dots 1.0 \times I_{Omax}$	250	300	350	kHz
I_{sense}	Remote sense current				8	mA
I_I	Static input current	$V_I = 3.8 \text{ V}$, $I_O = I_{Omax}$, $T_{ref} = 25 \text{ }^\circ\text{C}$		9.3		A
MTBF	Predicted reliability	$T_{ref} = 40 \text{ }^\circ\text{C}$		6		million hours

Adjusted to 3.3 V out - Typical Characteristics

General conditions: Input filter 2 x 22 μ F, Output filter 1 x 150 μ F

Efficiency

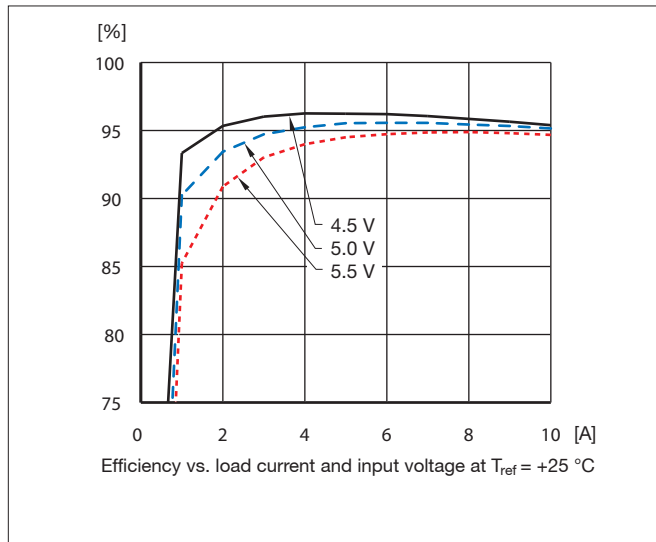

Power Dissipation

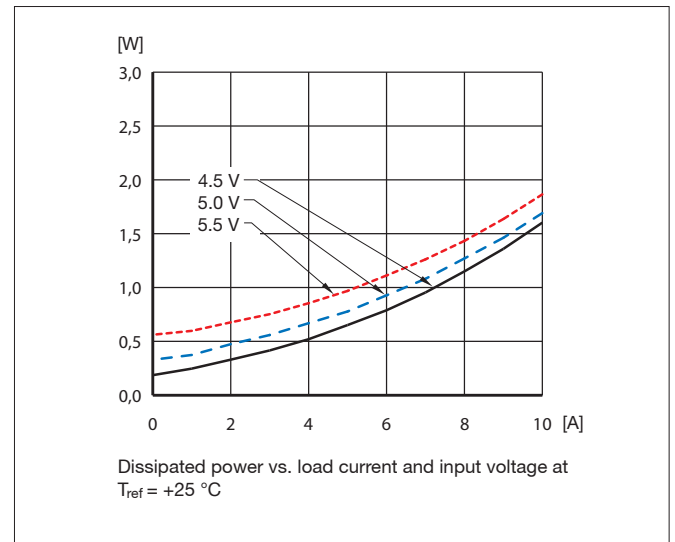

Output Characteristic

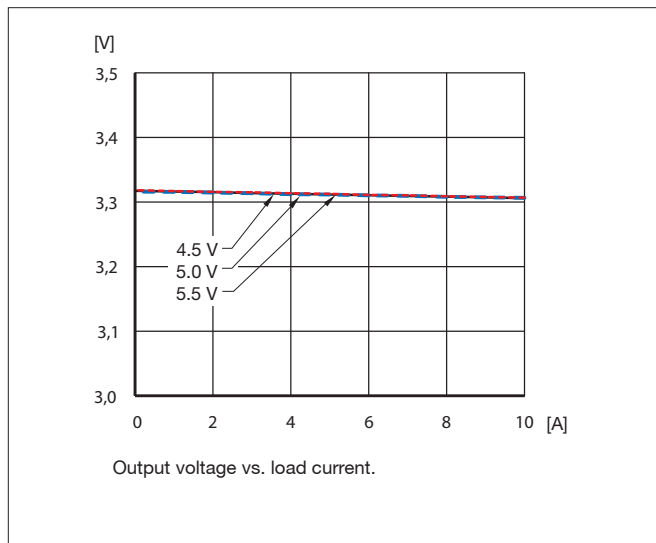

Output Current Derating at 5 V input

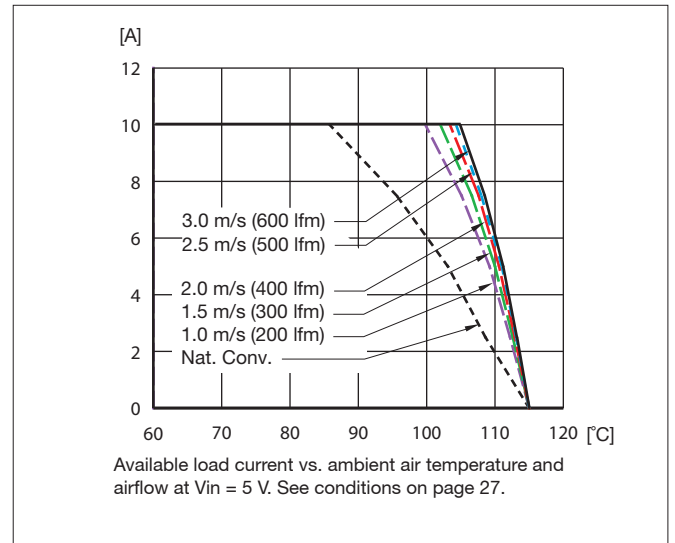

Start-Up

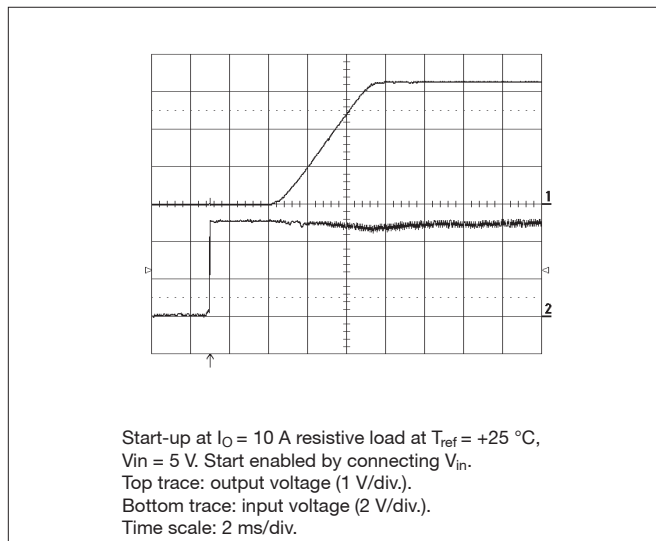

Turn Off

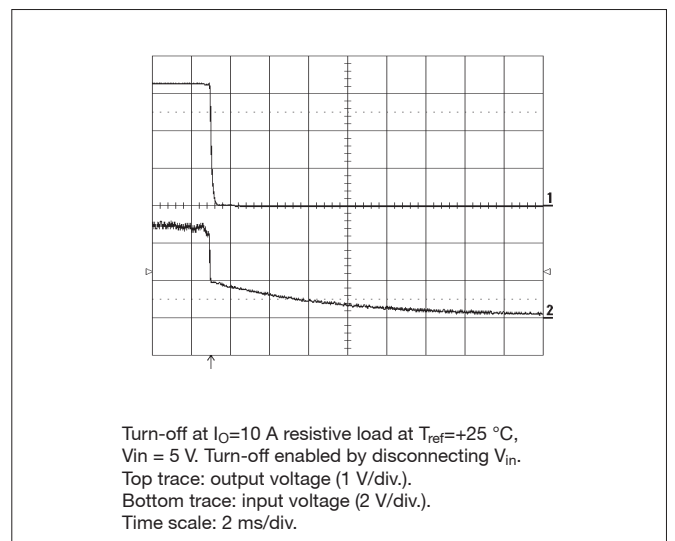

Adjusted to 3.3 V out - Typical Characteristics

General conditions: Input filter 2 x 22 μ F, Output filter 1 x 150 μ F

Output Ripple

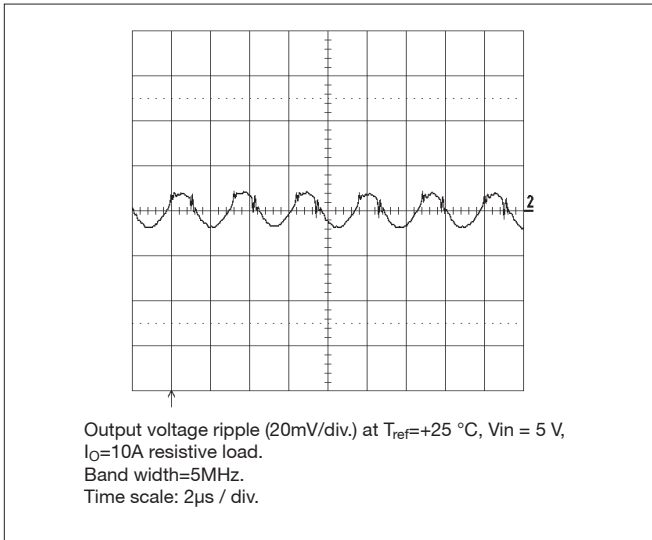

Transient with 150 μ F output capacitor

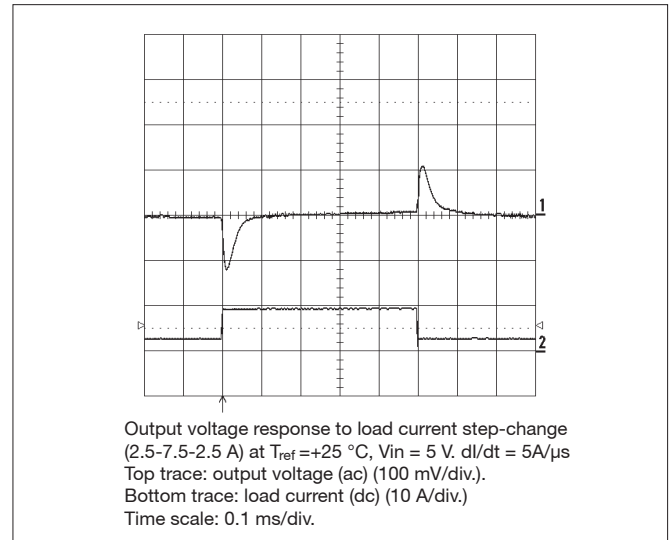

Transient with 300 μ F output capacitor

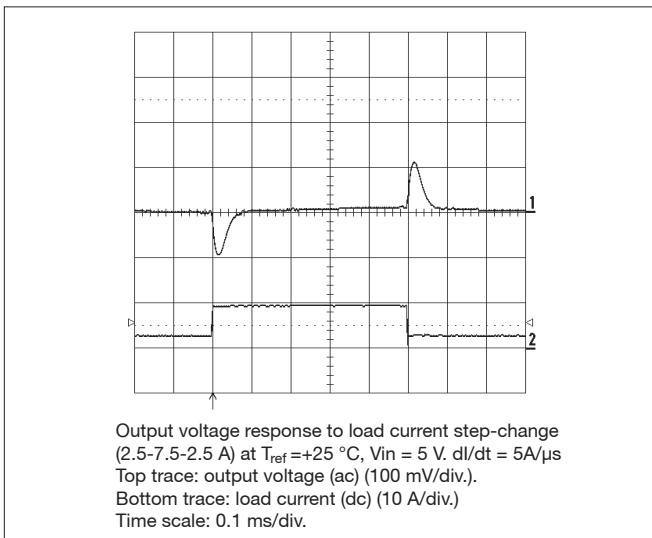

EMC Specification

Layout Recommendation

The radiated EMI performance of the DC/DC regulator will be optimised by including a ground plane in the PCB area under the DC/DC regulator. This approach will return switching noise to ground as directly as possible, with improvements to both emission and susceptibility.

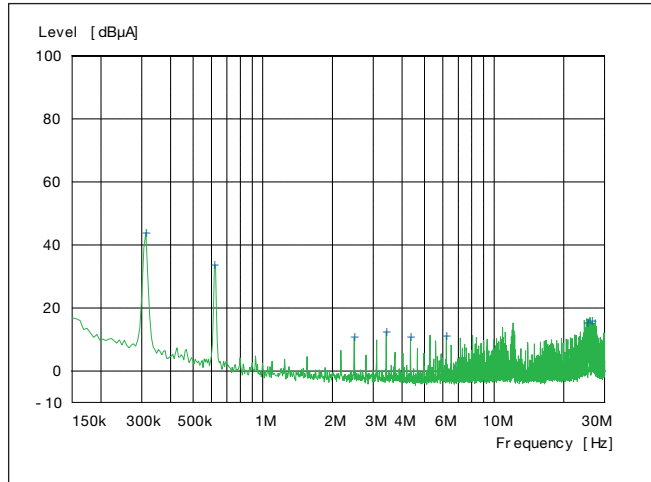

Operating Information

Remote Control (RC)

The RC pin may be used to turn on or turn off the regulator using a suitable open collector function.

Turn off is achieved by connecting the RC pin to the input voltage.

The regulator will run in normal operation when the RC pin is left open.

RC	Regulator condition	min	typ	max	Unit
High level referenced to GND	OFF	1.7		5.5	V
Open	ON				

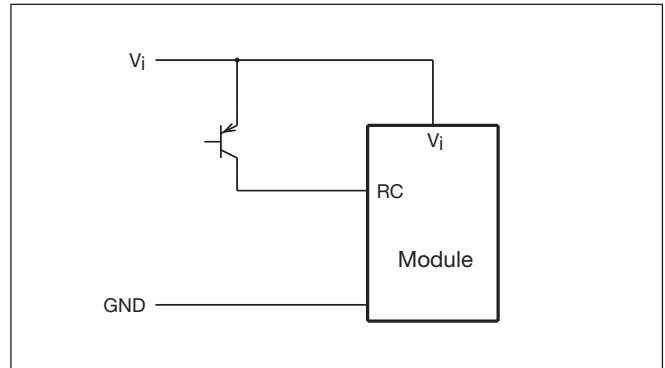

Remote Sense

All PMB 4000 Series DC/DC regulators have a positive remote sense pin that can be used to compensate for moderate amounts of resistance in the distribution system and allow for voltage regulation at the load or other selected point. The remote sense line will carry very little current and does not need a large cross sectional area. However, the sense line on the PCB should be located close to a ground trace or ground plane. The remote sense circuitry will compensate for up to 10% voltage drop between the sense voltage and the voltage at the output pins from $V_{O\text{nom}}$. If the remote sense is not needed the sense pin should be left open.

Operating Information

Output Voltage Adjust (V_{adj})

The output voltage can be set by means of an external resistor, connected to the V_{adj} pin. Nominal output voltage 0.75 V is set by leaving the V_{adj} pin open. Adjustment can only be made to increase the output voltage setting.

To increase:

Connect a resistor between (V_{adj}) and (Gnd). The output voltage increases with decreasing resistor value as shown in the table below. Note that the maximum output voltage 3.63 V may not be exceeded.

$$R_{ext} \text{ up (kohm)} = (21.007 / (V_O - 0.75225)) - 5.1$$

Output Voltage (V)	Resistor (ohm)
0.75	Open
1.0	79.691 k
1.2	41.817 k
1.5	22.990 k
1.8	14.949 k
2.5	6.919 k
3.3	3.145 k

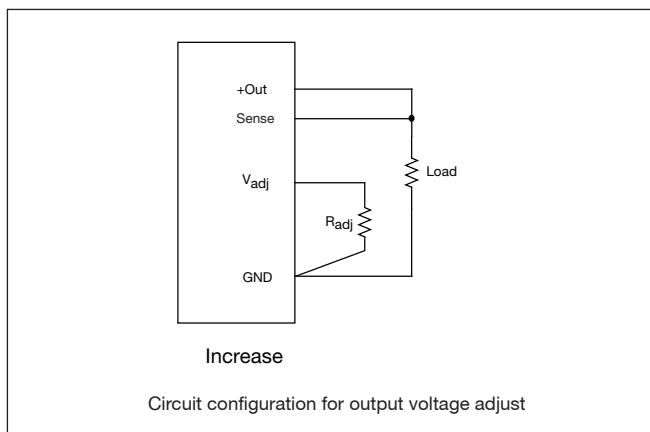

Current Limit Protection

The PMB 4000 Series DC/DC regulators include current limiting circuitry that allows them to withstand continuous overloads or short circuit conditions on the output. The current limit is of hick-up mode type.

The regulator will resume normal operation after removal of the overload. The load distribution system should be designed to carry the maximum output short circuit current specified.

Input And Output Impedance

The impedance of both the power source and the load will interact with the impedance of the DC/DC regulator. It is most important to have a low characteristic impedance, both at the input and output, as the regulators have a low energy storage capability. Use capacitors across the input if the source inductance is greater than 4.7 μH . Suitable input capacitors are 22 μF - 220 μF low ESR ceramics.

Minimum Required External Capacitors

External input capacitors are required to increase the lifetime of the internal capacitors and to further reduce the input ripple. A minimum of 44 μF external input capacitance with low ESR should be added.

A minimum of 150 μF external output capacitance, low ESR, should be added for the converter to operate properly at full load.

Maximum Capacitive Load

When powering loads with significant dynamic current requirements, the voltage regulation at the load can be improved by addition of decoupling capacitance at the load. The most effective technique is to locate low ESR ceramic capacitors as close to the load as possible, using several capacitors to lower the total ESR. These ceramic capacitors will handle short duration high-frequency components of dynamic load changes. In addition, higher values of capacitors (electrolytic capacitors) should be used to handle the mid-frequency components. It is equally important to use good design practice when configuring the DC distribution system.

Low resistance and low inductance PCB layouts and cabling should be used. Remember that when using remote sensing, all resistance (including the ESR), inductance and capacitance of the distribution system is within the feedback loop of the regulator. This can affect on the regulators compensation and the resulting stability and dynamic response performance.

Very low ESR and high capacitance must be used with care. A "rule of thumb" is that the total capacitance must never exceed typically 500-700 μF if only low ESR ($< 2 \text{ m}\Omega$) ceramic capacitors are used. If more capacitance is needed, a combination of low ESR type and electrolytic capacitors should be used, otherwise the stability will be affected.

The PMB 4000 series regulator can accept up to 5 mF of capacitive load on the output at full load. This gives $< 500 \mu\text{F}/\text{A}$ of I_O . When using that large capacitance it is important to consider the selection of output capacitors; the resulting behavior is a combination of the amount of capacitance and ESR.

Operating Information

A combination of low ESR and output capacitance exceeding 5 mF can cause the regulator into over current protection mode (hick-up) due to high start up current. The output filter must therefore be designed without exceeding the above stated capacitance levels if the ESR is lower than 30-40 mΩ.

Parallel Operation

The PMB 4000 Series DC/DC regulators can be connected in parallel with a common input. Paralleling is accomplished by connecting the output voltage pins directly and using a load sharing device on the input. Layout considerations should be made to avoid load imbalance. For more details on paralleling, please consult your local applications support.

Input Undervoltage Lockout

The PMB 4000 Series DC/DC regulators are equipped with a lockout function for low input voltage. When the input voltage is below the undervoltage lockout limit of the regulator it will shut off. When the input voltage increases above the lockout level the regulator will turn on.

Thermal Considerations

General

The PMB 4000 Series DC/DC regulators are designed to operate in a variety of thermal environments, however sufficient cooling should be provided to help ensure reliable operation. Heat is removed by conduction, convection and radiation to the surrounding environment. Increased airflow enhances the heat transfer via convection. Proper cooling can be verified by measuring the temperature at the reference point (T_{ref}).

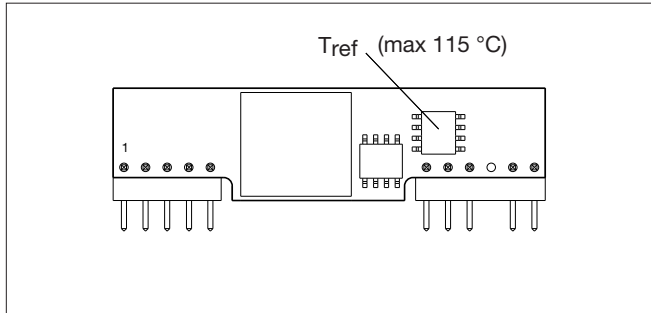

The PMB 4000 thermal testing is performed with the product mounted on an FR4 board 254 × 254 mm with 8 layers of 35 μ m copper. Airflow is perpendicular to the T_{ref} side.

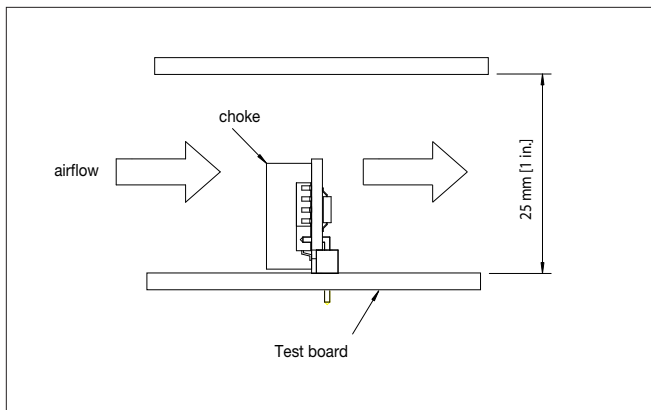

Calculation of ambient temperature

By using the thermal resistance the maximum allowed ambient temperature can be calculated.

A. The powerloss is calculated by using the formula $((1/\eta) - 1) \times \text{output power} = \text{power losses}$.
 η = efficiency of regulator. Example: 95% = 0.95

B. Find the value of the thermal resistance $R_{th T_{ref}-A}$ in the diagram by using the airflow speed at the module. Take the thermal resistance \times powerloss to get the temperature increase.

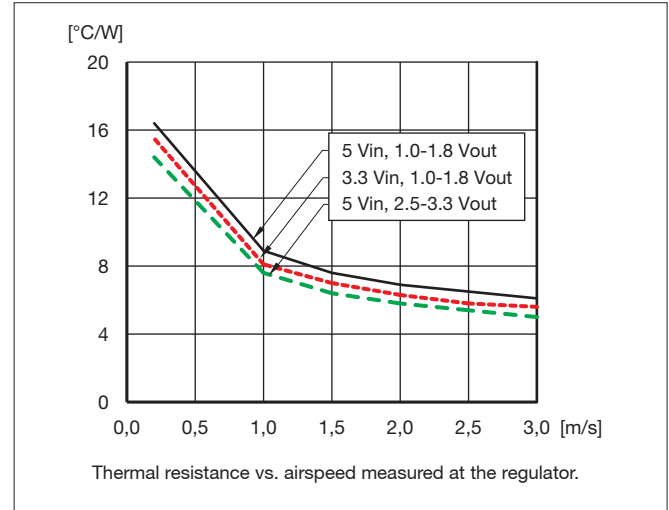

C. Max allowed calculated ambient temperature is:
 Max T_{ref} of DC/DC regulator - temperature increase.

Example: 5V input, 1.8 V output at 1m/s, full load:

A. $((1/0.9) - 1) \times 18 \text{ W} = 2 \text{ W}$

B. $2 \text{ W} \times 9 \text{ }^{\circ}\text{C}/\text{W} = 18 \text{ }^{\circ}\text{C}$

C. $115 \text{ }^{\circ}\text{C} - 18 \text{ }^{\circ}\text{C} = \text{max ambient temperature is } 97 \text{ }^{\circ}\text{C}$

The real temperature will be dependent on several factors, like PCB size and type, direction of airflow, air turbulence etc. It is recommended to verify the temperature by testing.

Soldering Information

The PMB 4000 series DC/DC regulators are intended for manual or wave soldering. The plastic body of the pin connectors resists soldering heat for limited time up to 260 °C.

When hand soldering, care should be taken to avoid direct contact between the hot soldering iron tip and the pins for more than a few seconds in order to avoid melting of the plastic.

Delivery Package Information

The PMB 4000 series regulators are delivered in antistatic trays with Jedec standard outer dimensions. Tray capacity 25 pcs. Each box contains 4 trays.

Reliability

The Mean Time Between Failure (MTBF) of the PMB 4000 series DC/DC regulator family is calculated to be greater than 6 million hours at full output power and a reference temperature of +40 °C using TelCordia SR 332.

Compatibility with RoHS requirements

The products are compatible with the relevant clauses and requirements of the RoHS directive 2002/95/EC and have a maximum concentration value of 0.1% by weight in homogeneous materials for lead, mercury, hexavalent chromium, PBB and PBDE and of 0.01% by weight in homogeneous materials for cadmium.

Exemptions in the RoHS directive utilized in Ericsson Power Modules products include:

- Lead in high melting temperature type solder (used to solder the die in semiconductor packages)
- Lead in glass of electronics components and in electronic ceramic parts (e.g. fill material in chip resistors)
- Lead as an alloying element in copper alloy containing up to 4% lead by weight (used in connection pins made of Brass)

Sales Offices and Contact Information

Company Headquarters
Ericsson Power Modules AB
LM Ericssons väg 30
SE-126 25 Stockholm
Sweden

Phone: +46-8-568-69620
Fax: +46-8-568-69599

China
Ericsson Simtek Electronics Co.
33 Fuhua Road
Jiading District
Shanghai 201 818
China

Phone: +86-21-5990-3258
Fax: +86-21-5990-0188

Germany, Austria
Ericsson Power Modules AB
Mühlhauser Weg 18
85737 Ismaning
Germany

Phone: +49-89-9500-6905
Fax: +49-89-9500-6911

Hong Kong (Asia Pacific)
Ericsson Ltd.
12/F. Devon House
979 King's Road
Quarry Bay
Hong Kong

Phone: +852-2590-2453
Fax: +852-2590-7152

Italy, Spain (Mediterranean)
Ericsson Power Modules AB
Via Cadorna 71
20090 Vimodrone (MI)
Italy

Phone: +39-02-265-946-07
Fax: +39-02-265-946-69

Japan
Ericsson Power Modules AB
Kimura Daini Building, 3 FL.
3-29-7 Minami-Oomachi, Shinagawa-ka
Tokyo 140-0013
Japan

Phone: +81-3-5733-5107
Fax: +81-3-5753-5162

North and South America
Ericsson Inc. Power Modules
6300 Legacy Dr.
Plano, TX 75024
USA

Phone: +1-972-583-5254
+1-972-583-6910
Fax: +1-972-583-7839

All other countries
Contact Company Headquarters
or visit our website:
www.ericsson.com/powermodules

Information given in this data sheet is believed to be accurate and reliable.
No responsibility is assumed for the consequences of its use nor for any infringement of patents or other rights of third parties which may result from its use.
No license is granted by implication or otherwise under any patent or patent rights of Ericsson Power Modules. These products are sold only according to Ericsson Power Modules' general conditions of sale, unless otherwise confirmed in writing. Specifications subject to change without notice.