

## Low Dropout 600mA Fixed Voltage Linear Regulator

### Features

- **Low Dropout Voltage: 220mV (Typical) @600mA**
- **Wide Input Voltage from 2.9V~6V**
- **Low Quiescent Current: 140mA**
- **Output Voltage Range : 1~5V**
- **Fixed Output Voltage with 2% Accuracy**
- **Stable with a Low ESR, 2.2mF Output Capacitance**
- **Short Circuit Current Limit**
- **Over-Temperature Protection**
- **Current-Limit Protection**
- **Internal Soft-Start**
- **SOT-23, SOT-89, and SOT-223 Packages**
- **Lead Free and Green Devices Available (RoHS Compliant)**

### General Description

The APL5601/5602 family of low-power and low dropout linear regulators which operate from 2.9V to 6V input voltage and deliver up to 600mA output current. Typical dropout voltage is only 220mV (typical) at 600mA output. The APL5601/5602 regulators with low 140μA quiescent current are ideal for battery-powered system appliances. The APL5601/5602 regulators are stable with a 2.2μF ceramic capacitor. The features of current limit, short circuit current limit, and over-temperature protection protect the device against current over loads and overtemperature. The APL5601/5602 regulators come in SOT-23, SOT-89, and SOT-223 packages.

### Applications

- **CD/DVD-ROM, CD-R/W**
- **Networking System, LAN Card, ADSL/Cable Modem**
- **Set-Top Box**
- **PC Peripherals**
- **Battery-Powered System**

### Simplified Application Circuit

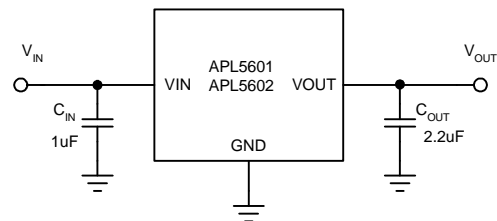

### Pin Configuration

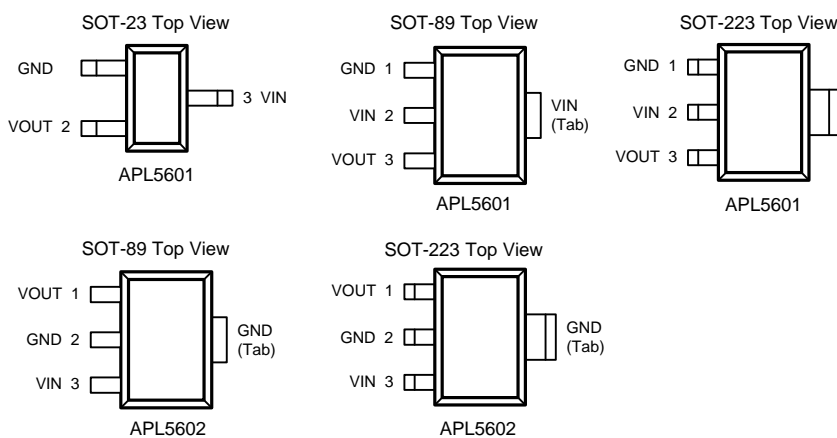

ANPEC reserves the right to make changes to improve reliability or manufacturability without notice, and advise customers to obtain the latest version of relevant information to verify before placing orders.

## Ordering and Marking Information

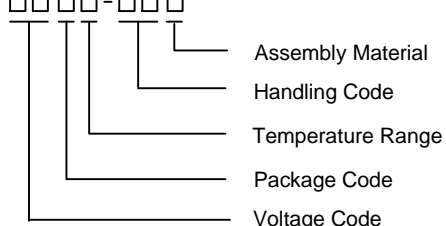
<p>APL5601 - □□□□-□□□□ APL5602</p>  <p>Assembly Material Handling Code Temperature Range Package Code Voltage Code</p>	<p>Voltage Code (Note 1) 10 : 1.0V 12 : 1.2V 15 : 1.5V 18 : 1.8V 25 : 2.5V 28 : 2.8V 30 : 3.0V 31 : 3.1V 33 : 3.3V</p> <p>Package Code A : SOT-23 D : SOT-89 V : SOT-223</p> <p>Operating Ambient Temperature Range I : -40 to 85 °C</p> <p>Handling Code TR : Tape &amp; Reel</p> <p>Assembly Material G : Halogen and Lead Free Device</p>		
<p>APL5601-10 D/V : <table border="1" style="display: inline-table; vertical-align: middle;"><tr><td>APL5601 XXXXX 10</td></tr></table></p> <p>APL5602-10 D/V : <table border="1" style="display: inline-table; vertical-align: middle;"><tr><td>APL5602 XXXXX 10</td></tr></table></p>	APL5601 XXXXX 10	APL5602 XXXXX 10	<p>XXXXX - Date Code 10 - Voltage Code</p>
APL5601 XXXXX 10			
APL5602 XXXXX 10			

Note : ANPEC lead-free products contain molding compounds/die attach materials and 100% matte tin plate termination finish; which are fully compliant with RoHS. ANPEC lead-free products meet or exceed the lead-free requirements of IPC/JEDEC J-STD-020D for MSL classification at lead-free peak reflow temperature. ANPEC defines “Green” to mean lead-free (RoHS compliant) and halogen free (Br or Cl does not exceed 900ppm by weight in homogeneous material and total of Br and Cl does not exceed 1500ppm by weight).

Note 1: For other voltage versions please contact ANPEC for details.

### Marking for SOT-23

Product Name	Marking
APL5601-10A	61aX
APL5601-12A	615X
APL5601-15A	619X
APL5601-18A	61CX
APL5601-25A	61JX
APL5601-28A	61MX
APL5601-30A	61OX
APL5601-31A	61PX
APL5601-33A	61RX

Note : The last character in the Marking, “X”, refers to date code.

## Absolute Maximum Ratings (Note 2)

Symbol	Parameter	Rating	Unit
$V_{IN}$	VIN Supply Voltage (VIN to GND)	-0.3 to 6.5	V
$V_{OUT}$	Output Voltage (VOUT to GND)	-0.3 to $V_{IN}+0.3$	V
$P_D$	Power Dissipation	Internally Limited	
$T_J$	Maximum Junction Temperature	150	°C
$T_{STG}$	Storage Temperature Range	-65 to 150	°C
$T_{SDR}$	Maximum Lead Soldering Temperature, 10 Seconds	260	°C

Note 2: Stresses beyond the absolute maximum rating may damage the device and exposure to absolute maximum rating conditions for extended periods may affect device reliability.

## Thermal Characteristics (Note 3, 4)

Symbol	Parameter	Typical Value	Unit
$\theta_{JA}$	Junction to Air Thermal Resistance	SOT-23	260
		SOT-89	180
		SOT-223	135
$\theta_{JC}$	Junction to Case Thermal Resistance	SOT-23	130
		SOT-89	40
		SOT-223	15

Note 3: At elevated temperatures, device power dissipation must be derated based on package thermal resistance and heatsink values. The junction-to-ambient thermal resistance is measured on a PC board mounting with the device soldered down to minimum copper area. If power dissipation causes the junction temperature to exceed specified limits, the device will go into thermal shutdown.

Note 4: The maximum allowable power dissipation at any  $T_A$  (ambient temperature) is calculated using:  $P_{D(max)} = (T_J - T_A) / \theta_{JA}$ ;  $T_J = 125^\circ\text{C}$ . Exceeding the maximum allowable power dissipation will result in excessive die temperature.

## Recommended Operating Conditions

Symbol	Parameter	Range	Unit
$V_{IN}$	VIN Supply Voltage	2.9 to 6	V
$I_{OUT}$	Output Current	0 to 0.6	A
$C_{IN}$	Input Capacitor	0.82 to 470	$\mu\text{F}$
$C_{OUT}$	Output Capacitor	1 to 330	$\mu\text{F}$
$T_J$	Junction Temperature	-40 to 125	$^\circ\text{C}$
$T_A$	Ambient Temperature	-40 to 85	$^\circ\text{C}$

## Electrical Characteristics

Refer to the typical application circuit.  $V_{IN} = V_{OUT} + 1\text{V}$  or (Minimum  $V_{IN} = 2.9\text{V}$ ),  $V_{EN} = V_{IN}$ ,  $I_{OUT} = 1\text{mA}$ ,  $T_J = -40$  to  $125^\circ\text{C}$ ,  $T_A = -40$  to  $85^\circ\text{C}$ , unless otherwise specified. Typical values are at  $T_A = 25^\circ\text{C}$ .

Symbol	Parameter	Test Conditions	APL5601/APL5602			Unit
			Min.	Typ.	Max.	
<b>SUPPLY CURRENT</b>						
$I_Q$	Quiescent Current	$V_{EN} = 0\text{V}$	-	-	1	$\mu\text{A}$
		$V_{IN} = V_{EN} = 5\text{V}$ , $I_{OUT} = 0\text{mA}$	-	140	200	$\mu\text{A}$
<b>UNDER-VOLTAGE-LOCKOUT</b>						
	VIN UVLO Threshold	$V_{IN}$ rising	2.1	2.5	2.9	V
	VIN UVLO Hysteresis		-	0.15	-	V
<b>OUTPUT VOLTAGE</b>						
$V_{OUT}$	Output Voltage	$T_A = 25^\circ\text{C}$	-1	-	+1	$\%V_{OUT}$
		$T_A = -40$ to $85^\circ\text{C}$ ( $T_J = -40$ to $125^\circ\text{C}$ )	-2	-	+2	
	Line Regulation	$V_{IN} = V_{OUT} + 1\text{V}$ to $6\text{V}$	-	0.03	0.1	$\%/V$
	Load Regulation	$I_{OUT} = 1\text{mA}$ to $600\text{mA}$	-	0.6	1.5	$\%/A$

### Electrical Characteristics (Cont.)

Refer to the typical application circuit.  $V_{IN} = V_{OUT} + 1V$  or (Minimum  $V_{IN} = 2.9V$ ),  $V_{EN} = V_{IN}$ ,  $I_{OUT} = 1mA$ ,  $T_J = -40$  to  $125\text{ }^\circ\text{C}$ ,  $T_A = -40$  to  $85\text{ }^\circ\text{C}$ . unless otherwise specified. Typical values are at  $T_A = 25\text{ }^\circ\text{C}$ .

Symbol	Parameter	Test Conditions	APL5601/APL5602			Unit
			Min.	Typ.	Max.	
<b>OUTPUT VOLTAGE (Cont.)</b>						
$V_{DROP}$	Dropout Voltage	$V_{OUT} = 2.8V, I_{OUT} = 600mA$	-	240	400	mV
		$V_{OUT} = 3.3V, I_{OUT} = 600mA$	-	220	350	
		$V_{OUT} = 5V, I_{OUT} = 600mA$	-	200	320	
PSRR	Power Supply Ripple Rejection	$V_{IN} = V_{OUT} + 2V, f = 1kHz$	-	55	-	dB
<b>SOFT-START AND PROTECTION</b>						
$I_{LM}$	Output Current Limit		700	-	-	mA
	Thermal Shutdown Temperature		-	150	-	$^\circ\text{C}$
	Thermal Shutdown Hysteresis		-	40	-	$^\circ\text{C}$
	Short Circuit Current Limit	$V_{OUT} < 0.6V$	-	250	-	mA
$T_{SS}$	Soft-Start Time		-	130	300	$\mu\text{s}$

### Pin Description

PIN	FUNCTION
VIN	Input Supply Pin. Supply voltage can range from 2.9V to 6V. Bypass with a 1 $\mu\text{F}$ capacitor to the GND
VOU	Regulator Output. Sources up to 600mA. A small capacitor is needed from this pin to ground to assure stability.
GND	Ground.

### Typical Operating Characteristics

$V_{IN}=5V$ ,  $V_{OUT}=3.3V$ ,  $C_{IN}=1\mu F$ ,  $C_{OUT}=2.2\mu F$ ,  $T_A=25^\circ C$ , unless otherwise specified.

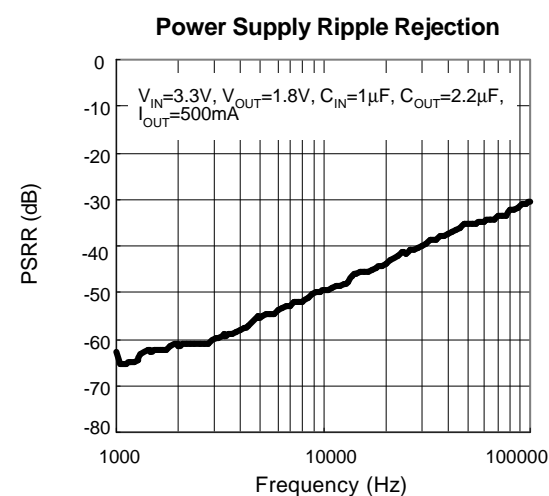
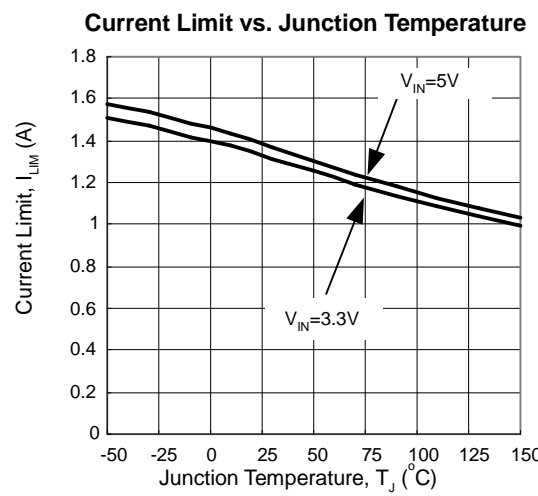
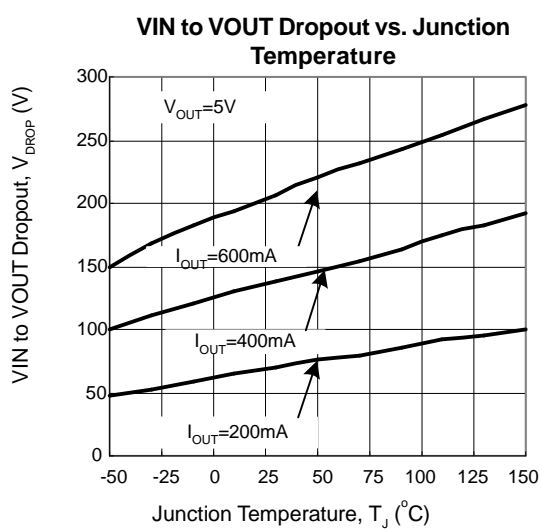
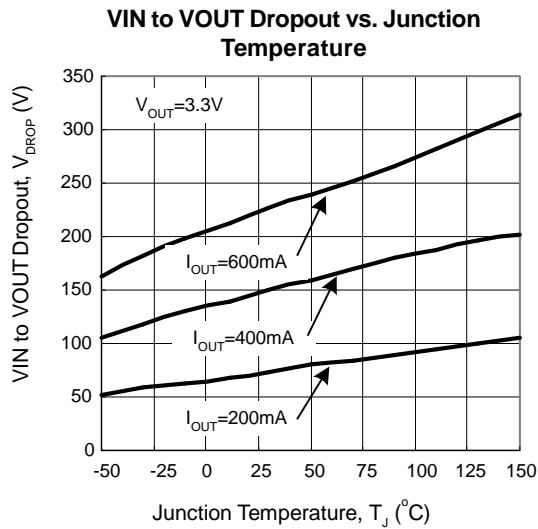
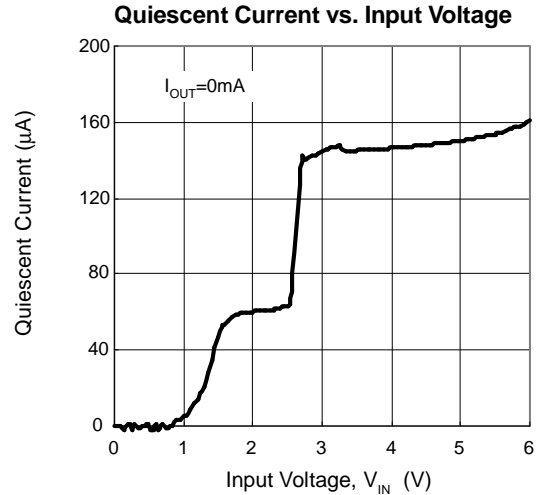
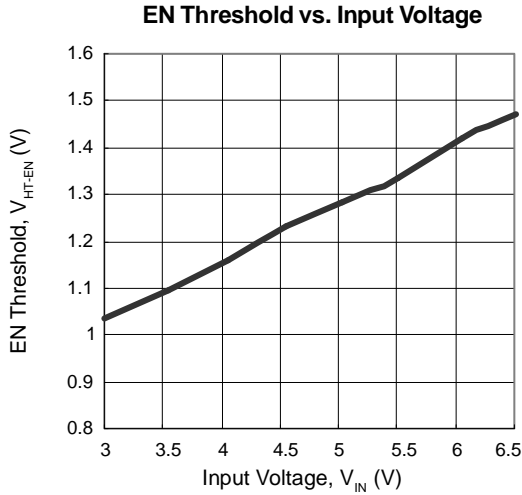

## Operating Waveforms

$V_{IN}=5V$ ,  $V_{OUT}=3.3V$ ,  $C_{IN}=1\mu F$ ,  $C_{OUT}=2.2\mu F$ ,  $T_A=25^\circ C$ , unless otherwise specified.

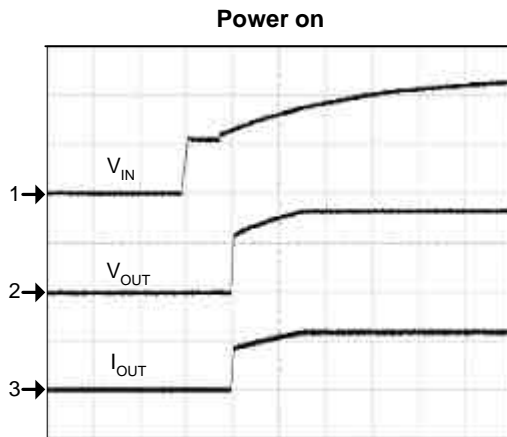

CH1 :  $V_{IN}$ , 2V/div  
 CH3 :  $V_{OUT}$ , 2V/div  
 CH4 :  $I_{OUT}$ , 500mA/div  
 Time : 1ms/div

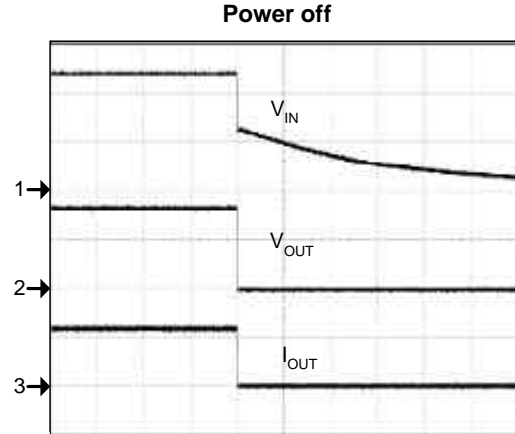

CH1 :  $V_{IN}$ , 2V/div  
 CH2 :  $V_{OUT}$ , 2V/div  
 CH3 :  $I_{OUT}$ , 500mA/div  
 Time : 200ms/div

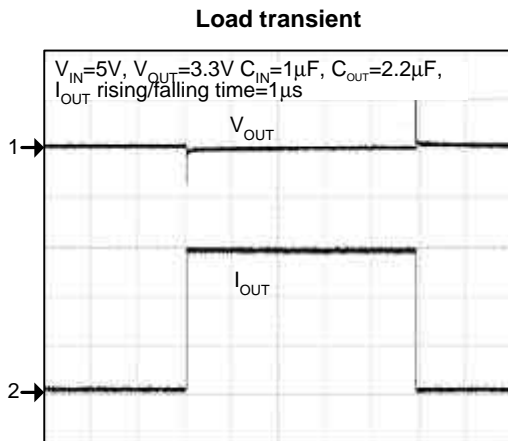

CH1 :  $V_{OUT}$ , 100mV/div (offset=3.3V)  
 CH2 :  $I_{OUT}$ , 200mV/div  
 Time : 200 $\mu s$ /div

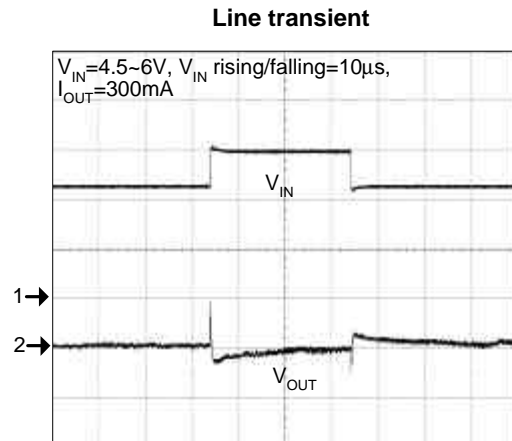

CH1 :  $V_{IN}$ , 2V/div  
 CH2 :  $V_{OUT}$ , 20mV/div (offset=3.3V)  
 Time : 200 $\mu s$ /div

Operating Waveforms (Cont.)

$V_{IN}=5V$ ,  $V_{OUT}=3.3V$ ,  $C_{IN}=1\mu F$ ,  $C_{OUT}=2.2\mu F$ ,  $T_A=25^\circ C$ , unless otherwise specified.

Thermal shutdown

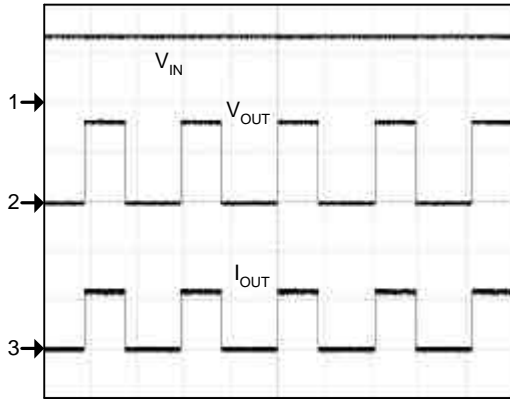

CH1 :  $V_{IN}$ , 5V/div  
 CH2 :  $V_{OUT}$ , 2V/div  
 CH3 :  $I_{OUT}$ , 500mA/div  
 Time : 500ms/div

Current limit and short circuit current limit

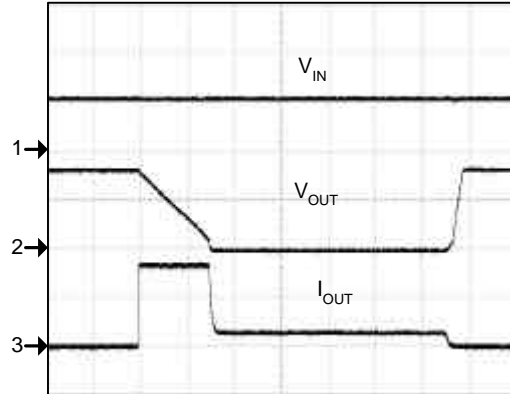

CH1 :  $V_{IN}$ , 5V/div  
 CH2 :  $V_{OUT}$ , 2V/div  
 CH3 :  $I_{OUT}$ , 1A/div  
 Time : 2ms/div

Block Diagram

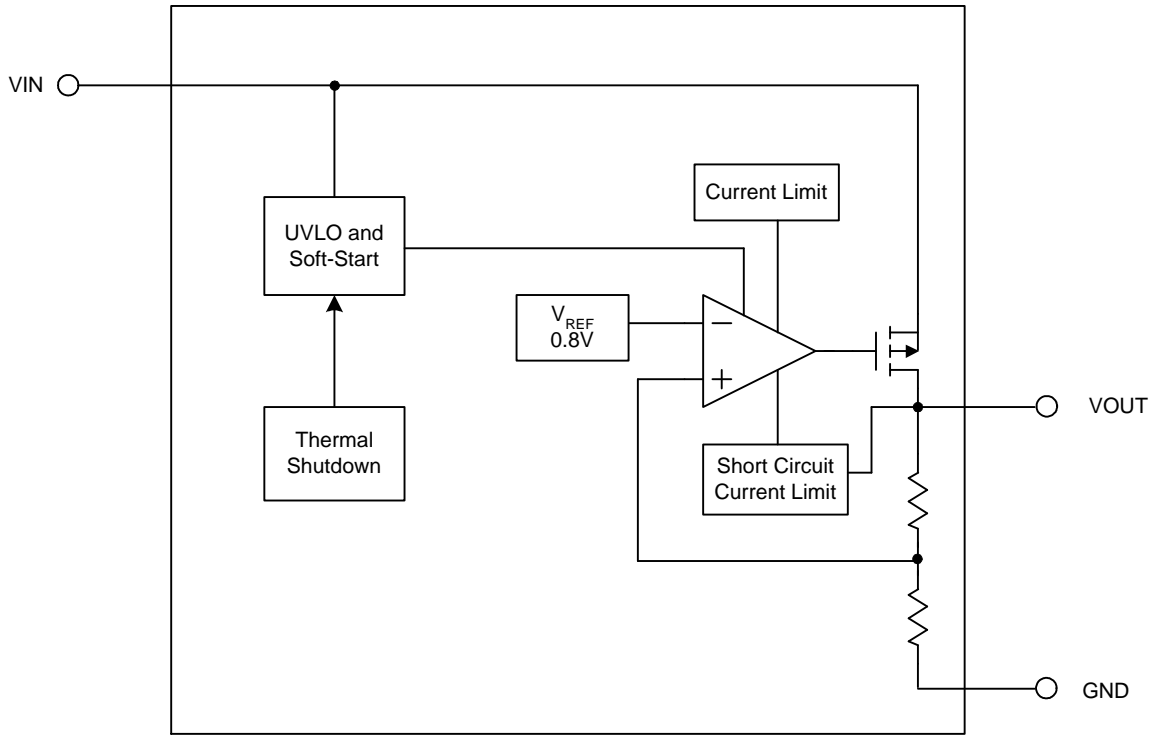

Typical Application Circuit

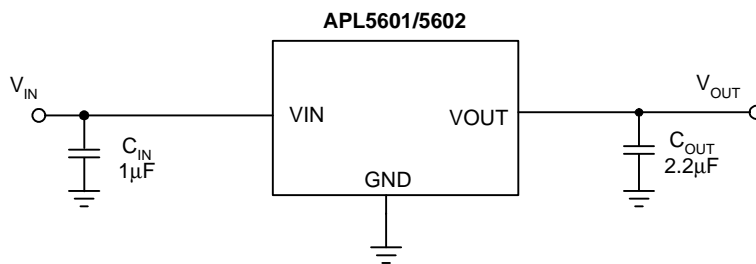



## Function Description

### Under Voltage Lockout (UVLO)

The APL5601/5602 regulators have built-in under-voltage lock-out circuits to keep the output shutting off until internal circuitry is operating properly. The UVLO function initiates a soft-start process after input voltage exceeds its rising UVLO threshold during power on. Typical UVLO threshold is 2.5V with 0.15V hysteresis.

### Soft-Start

The APL5601/5602 provide an internal soft-start circuitry to control rise rate of the output voltage and limit the current surge during start-up. Approximate 20 $\mu$ s delay time after the  $V_{IN}$  is over the UVLO threshold, the output voltage starts the soft-start. The typical soft-start interval is about 130 $\mu$ s.

### Current Limit

The APL5601/5602 provides a current limit circuitry, which monitors and controls P-MOS's gate voltage, limiting the output current to 700mA. For reliable operation, the device should not be operated in current limit for extended period.

### Short Circuit Current Limit

When the output voltage drops below 0.6V, which is caused by the over load or short circuit, the internal short circuit current limit circuitry limits the output current down to 250mA. The short circuit current limit is used to reduce the power dissipation during short circuit condition. In some high  $V_{IN}-V_{OUT}$  conditions, if the junction temperature is over the thermal shutdown temperature, the device will enter the thermal shutdown. Please refer to the section on thermal considerations for power dissipation calculations. The short circuit current limit has a blanking time feature after the UVLO threshold is reached, so that it will avoid the output causing short circuit current limit protection during start-up; the blanking time is about 600 $\mu$ s.

### Thermal Shutdown

A thermal shutdown circuit limits the junction temperature of APL5601/5602. When the junction temperature exceeds +150°C, the thermal shutdown circuitry disables the output, allowing the device to cool down. The output circuitry is enabled again after the junction temperature cools down by 40°C, resulting in a pulsed output during continuous thermal overload conditions. Thermal protection is designed to protect the IC in the event of over temperature conditions. For reliable operation, the junction temperature cannot exceed  $T_{j,+125^{\circ}\text{C}}$ .

## Application Information

### Input Capacitor

The APL5601/5602 require proper input capacitors to supply surge current during stepping load transients to prevent the input rail from dropping. Because the parasitic inductor from the voltage sources or other bulk capacitors to the VIN limits the slew rate of the surge current, it is necessary to place the input capacitors near VIN as close as possible. Input capacitors should be larger than 0.82μF.

### Output Capacitor

The APL5601/5602 need a proper output capacitor to maintain circuit stability and to improve transient response over temperature and current. In order to insure the circuit stability, the proper output capacitor value should be larger than 1μF. With X5R and X7R dielectrics, 2.2μF is sufficient at all operating temperatures. Maximum output capacitor should be less than 330μF to insure the system can be powered on successfully.

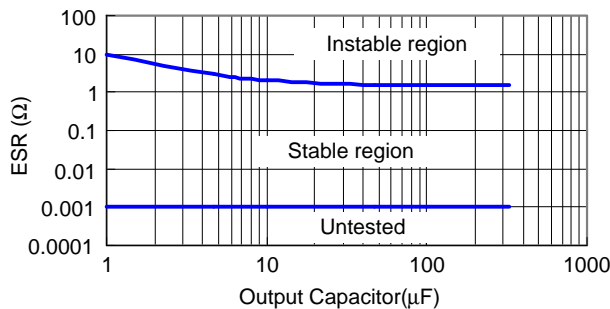

### Operation Region and Power Dissipation

The APL5601/5602 maximum power dissipation depends on the thermal resistance and temperature difference between the die junction and ambient air. The power dissipation  $P_D$  across the device is:

$$P_D = (T_J - T_A) / \theta_{JA}$$

where  $(T_J - T_A)$  is the temperature difference between the junction and ambient air.  $\theta_{JA}$  is the thermal resistance between junction and ambient air. Assuming the  $T_A = 25^\circ\text{C}$ , maximum  $T_J = 150^\circ\text{C}$  (typical thermal limit threshold) and  $\theta_{JA} = 260^\circ\text{C/W}$  (SOT-23), so the maximum power dissipation is calculated as:

$$P_{D(max)} = (150 - 25) / 260 = 0.48(\text{W})$$

For normal operation, do not exceed the maximum operating junction temperature of  $T_J = 125^\circ\text{C}$ . The calculated power dissipation should be less than:

$$P_D = (125 - 25) / 260 = 0.38(\text{W})$$

The pin 3 of the SOT-23 and the tabs (and pin 2) of the SOT-89 and SOT-223 provide an electrical connections and channel heat away. Connect the pins and tabs to a large area copper plane on PCBs for better heat dissipation.

### Layout Consideration

Figure 1 illustrates the layout. Below is a checklist for your layout:

1. Please place the input capacitors close to the VIN.
2. Ceramic capacitors for load must be placed near the load as close as possible.
3. To place APL5601/5602 and output capacitors near the load is good for performance.
4. Large current paths, the bold lines in figure 1, must have wide tracks.

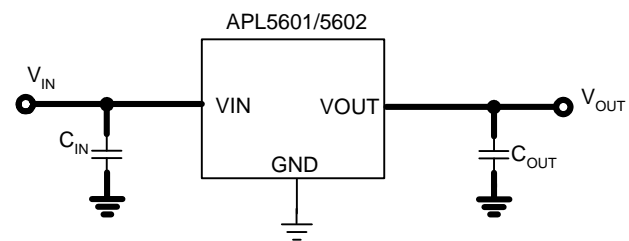
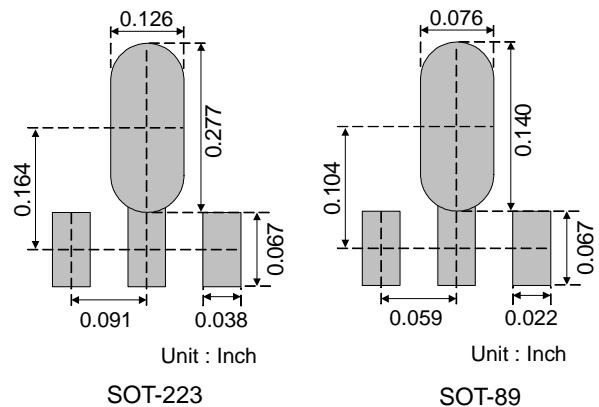

Figure 1

### Recommended Minimum Footprint



## Application Information (Cont.)

### Recommended Minimum Footprint (Cont.)

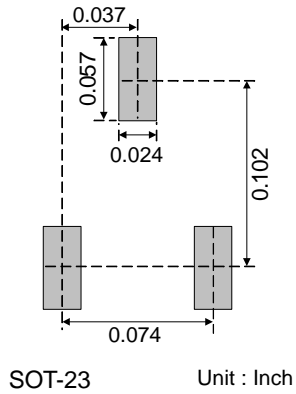

Package Information

SOT-23-3

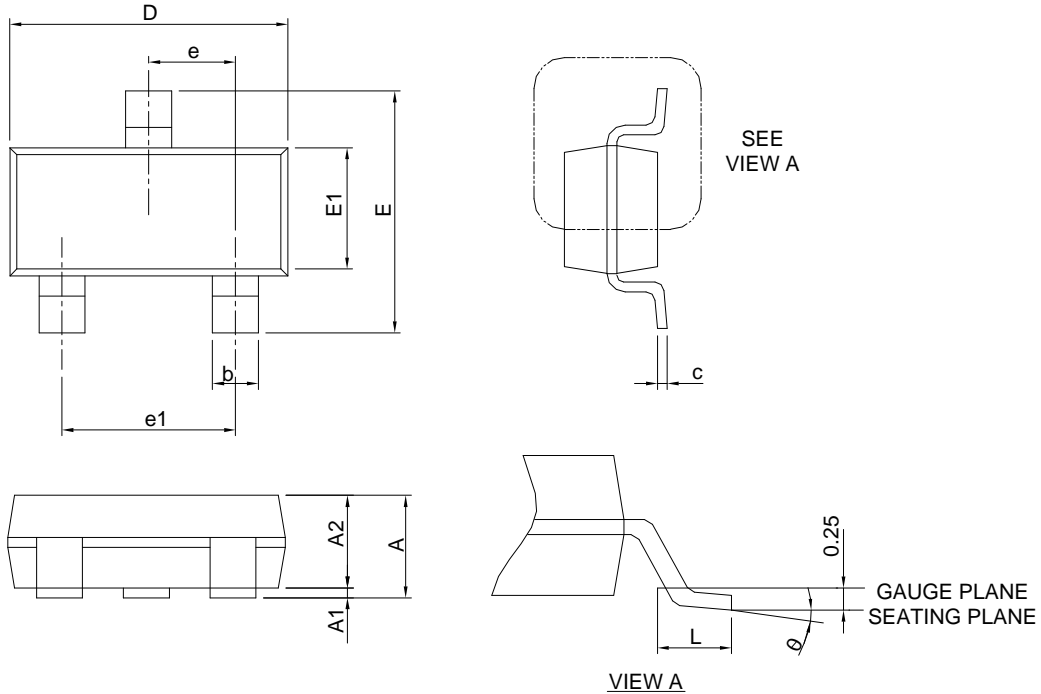

SYMBOL	SOT-23-3			
	MILLIMETERS		INCHES	
	MIN.	MAX.	MIN.	MAX.
A		1.45		0.057
A1	0.00	0.15	0.000	0.006
A2	0.90	1.30	0.035	0.051
b	0.30	0.50	0.012	0.020
c	0.08	0.22	0.003	0.009
D	2.70	3.10	0.106	0.122
E	2.60	3.00	0.102	0.118
E1	1.40	1.80	0.055	0.071
e	0.95 BSC		0.037 BSC	
e1	1.90 BSC		0.075 BSC	
L	0.30	0.60	0.012	0.024
θ	0°	8°	0°	8°

Note : Dimension D and E1 do not include mold flash, protrusions or gate burrs. Mold flash, protrusion or gate burrs shall not exceed 10 mil per side.

Package Information

SOT-89

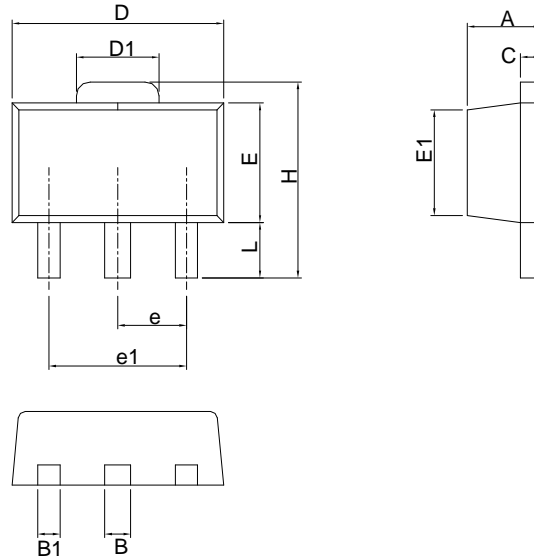

L O U T S	SOT-89			
	MILLIMETERS		INCHES	
	MIN.	MAX.	MIN.	MAX.
A	1.40	1.60	0.055	0.063
B	0.44	0.56	0.017	0.022
B1	0.36	0.48	0.014	0.019
C	0.35	0.44	0.014	0.017
D	4.40	4.60	0.173	0.181
D1	1.62	1.83	0.064	0.072
E	2.29	2.60	0.090	0.102
E1	2.13	2.29	0.084	0.090
e	1.50 BSC		0.059 BSC	
e1	3.00 BSC		0.118 BSC	
H	3.94	4.25	0.155	0.167
L	0.89	1.20	0.035	0.047

Note : Follow JEDEC TO-243 AA.

Package Information

SOT-223

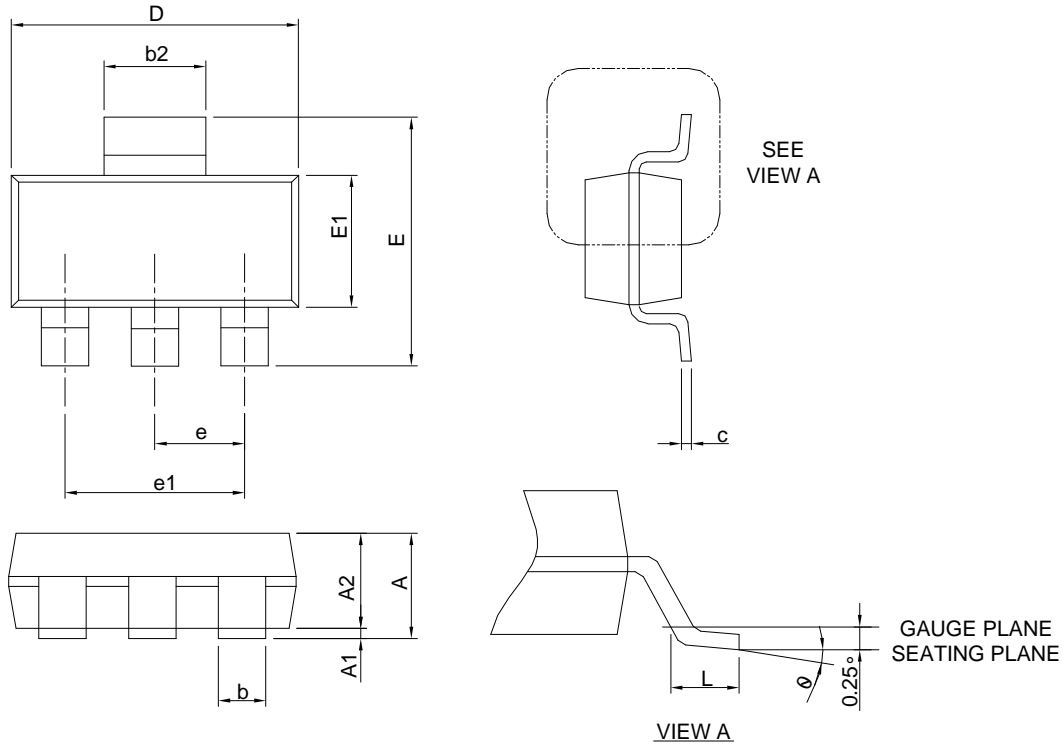

DIMENSIONS	SOT-223			
	MILLIMETERS		INCHES	
	MIN.	MAX.	MIN.	MAX.
A		1.80		0.071
A1	0.02	0.10	0.001	0.004
A2	1.50	1.70	0.059	0.067
b	0.66	0.84	0.026	0.033
b2	2.90	3.10	0.114	0.122
c	0.23	0.33	0.009	0.013
D	6.30	6.70	0.248	0.264
E	6.70	7.30	0.264	0.287
E1	3.30	3.70	0.130	0.146
e	2.30 BSC		0.091 BSC	
e1	4.60 BSC		0.181 BSC	
L	0.75		0.030	
θ	0°	10°	0°	10°

Note : 1. Follow from JEDEC TO-261 AA.  
 2. Dimension D and E1 are determined at the outermost extremes of the plastic exclusive of mold flash, tie bar burrs, gate burrs, and interlead flash, but including any mismatch between the top and bottom of the plastic body.

### Carrier Tape & Reel Dimensions

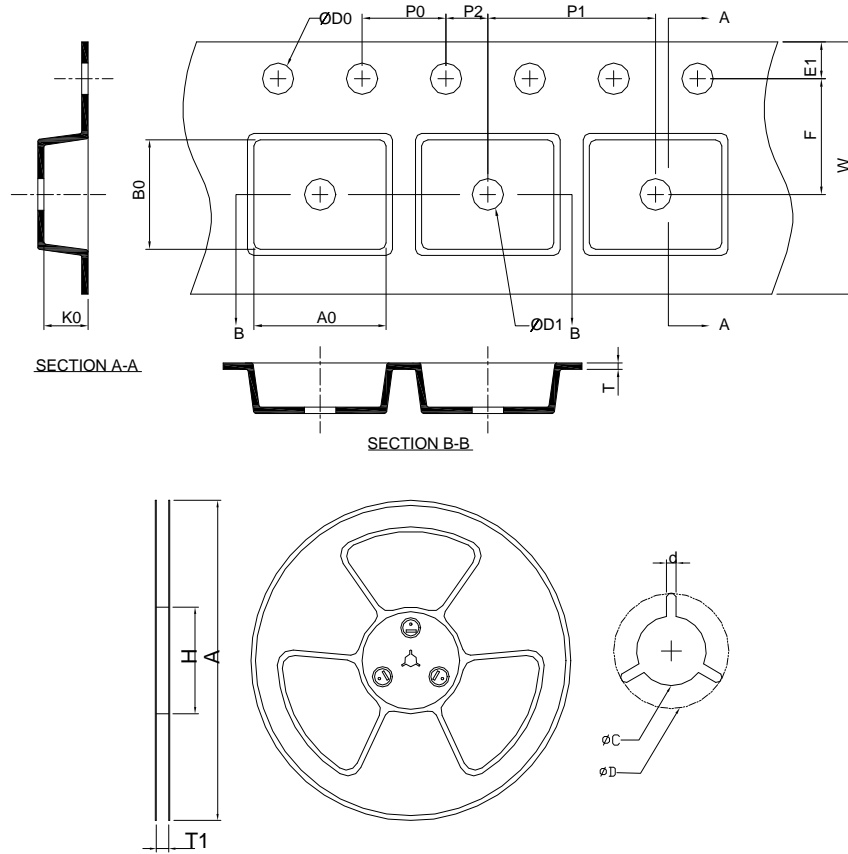

Application	A	H	T1	C	d	D	W	E1	F
SOT-23-3	178.0 ±0.00	50 MIN.	8.4+2.00 -0.00	13.0+0.50 -0.20	1.5 MIN.	20.2 MIN.	8.0 ±0.30	1.75 ±0.10	3.5 ±0.05
	<b>P0</b>	<b>P1</b>	<b>P2</b>	<b>D0</b>	<b>D1</b>	<b>T</b>	<b>A0</b>	<b>B0</b>	<b>K0</b>
	4.0 ±0.10	4.0 ±0.10	2.0 ±0.05	1.5+0.10 -0.00	1.0 MIN.	0.6+0.00 -0.40	3.20 ±0.20	3.10 ±0.20	1.50 ±0.20
Application	A	H	T1	C	d	D	W	E1	F
SOT-89	178.0 ±0.00	50 MIN.	12.4+2.00 -0.00	13.0+0.50 -0.20	1.5 MIN.	20.2 MIN.	12.0 ±0.30	1.75 ±0.10	5.50 ±0.05
	<b>P0</b>	<b>P1</b>	<b>P2</b>	<b>D0</b>	<b>D1</b>	<b>T</b>	<b>A0</b>	<b>B0</b>	<b>K0</b>
	4.0 ±0.10	8.0 ±0.10	2.0 ±0.05	1.5+0.10 -0.00	1.5 MIN.	0.6+0.00 -0.40	4.80 ±0.20	4.50 ±0.20	1.80 ±0.20
Application	A	H	T1	C	d	D	W	E1	F
SOT-223	320.0 ±0.00	50 MIN.	12.4+2.00 -0.00	13.0+0.50 -0.20	1.5 MIN.	20.2 MIN.	12.00 ±0.30	1.75 ±0.10	5.50 ±0.05
	<b>P0</b>	<b>P1</b>	<b>P2</b>	<b>D0</b>	<b>D1</b>	<b>T</b>	<b>A0</b>	<b>B0</b>	<b>K0</b>
	4.00 ±0.10	8.00 ±0.10	2.00 ±0.50	1.5+0.10 -0.00	1.5 MIN.	0.6+0.00 -0.40	6.90 ±0.20	7.50 ±0.20	2.10 ±0.20

(mm)

**Devices Per Unit**

Package type	Unit	Quantity
SOT-23-3	Tape & Reel	3000
SOT-89	Tape & Reel	1000
SOT-223	Tape & Reel	2500

**Taping Direction Information**

SOT-23-3

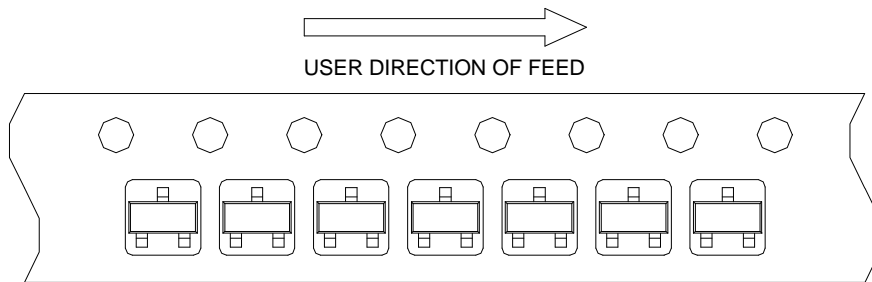

SOT-89

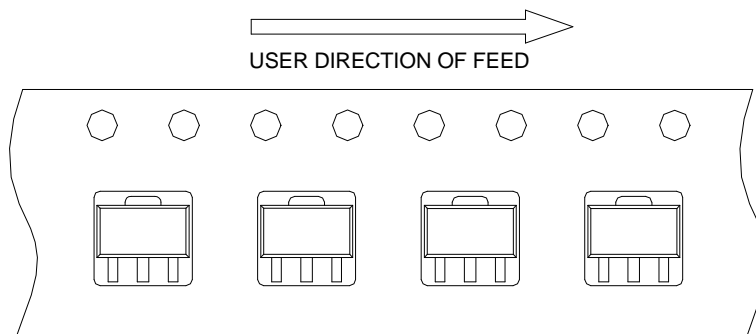

SOT-223

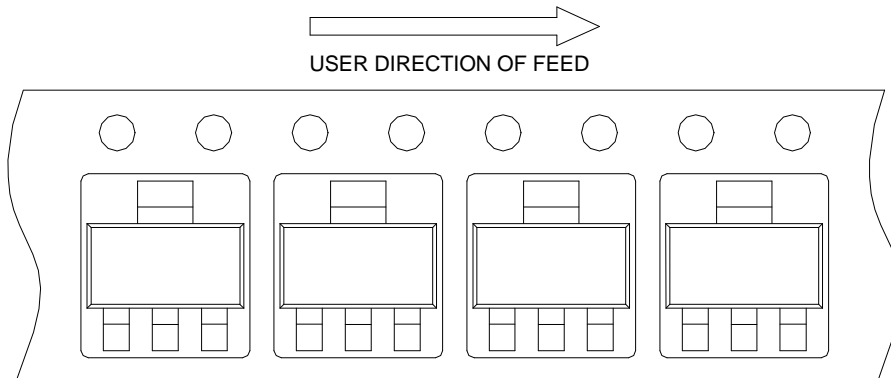



**Classification Profile**

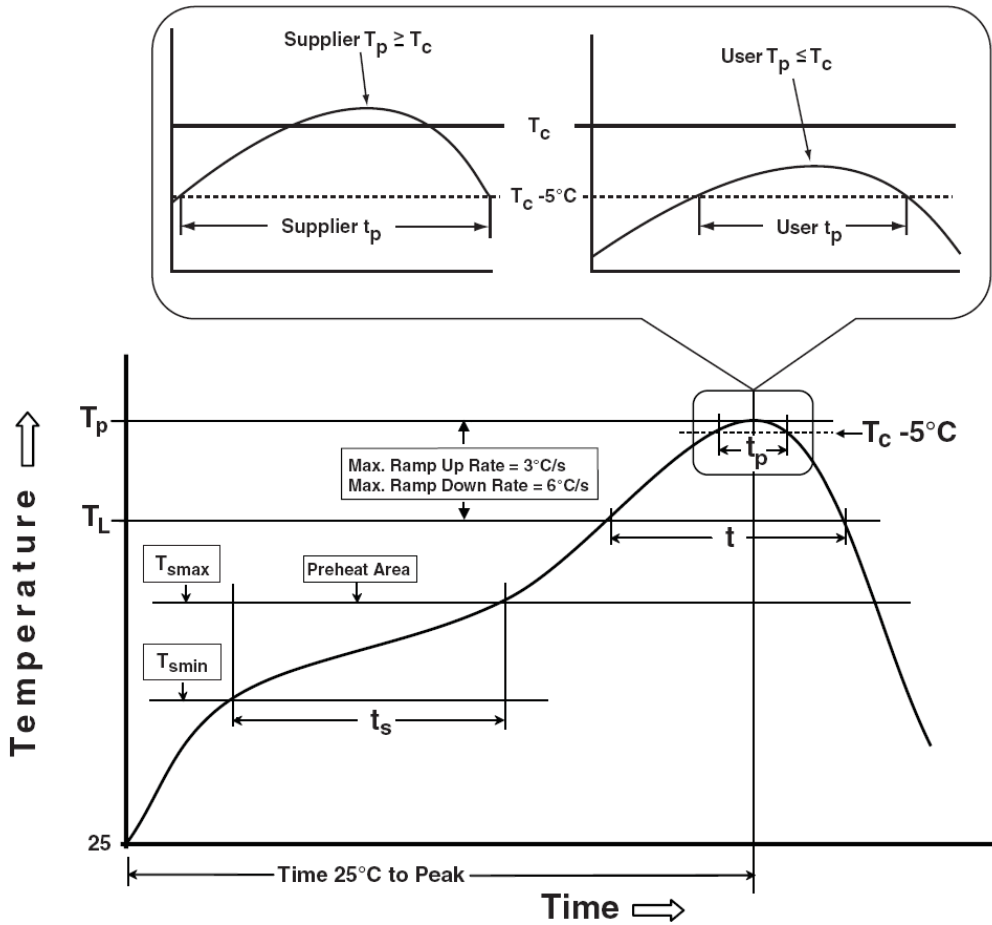

**Classification Reflow Profiles**

Profile Feature	Sn-Pb Eutectic Assembly	Pb-Free Assembly
<b>Preheat &amp; Soak</b>		
Temperature min ( $T_{smin}$ )	100 °C	150 °C
Temperature max ( $T_{smax}$ )	150 °C	200 °C
Time ( $T_{smin}$ to $T_{smax}$ ) ( $t_s$ )	60-120 seconds	60-120 seconds
Average ramp-up rate ( $T_{smax}$ to $T_p$ )	3 °C/second max.	3°C/second max.
Liquidous temperature ( $T_L$ )	183 °C	217 °C
Time at liquidous ( $t_L$ )	60-150 seconds	60-150 seconds
Peak package body Temperature ( $T_p$ )*	See Classification Temp in table 1	See Classification Temp in table 2
Time ( $t_p$ )** within 5°C of the specified classification temperature ( $T_c$ )	20** seconds	30** seconds
Average ramp-down rate ( $T_p$ to $T_{smax}$ )	6 °C/second max.	6 °C/second max.
Time 25°C to peak temperature	6 minutes max.	8 minutes max.
* Tolerance for peak profile Temperature ( $T_p$ ) is defined as a supplier minimum and a user maximum.		
** Tolerance for time at peak profile temperature ( $t_p$ ) is defined as a supplier minimum and a user maximum.		

**Classification Reflow Profiles (Cont.)**

Table 1. SnPb Eutectic Process – Classification Temperatures (Tc)

Package Thickness	Volume mm <sup>3</sup> <350	Volume mm <sup>3</sup> ≥350
<2.5 mm	235 °C	220 °C
≥2.5 mm	220 °C	220 °C

Table 2. Pb-free Process – Classification Temperatures (Tc)

Package Thickness	Volume mm <sup>3</sup> <350	Volume mm <sup>3</sup> 350-2000	Volume mm <sup>3</sup> >2000
<1.6 mm	260 °C	260 °C	260 °C
1.6 mm – 2.5 mm	260 °C	250 °C	245 °C
≥2.5 mm	250 °C	245 °C	245 °C

**Reliability Test Program**

Test item	Method	Description
SOLDERABILITY	JESD-22, B102	5 Sec, 245°C
HOLT	JESD-22, A108	1000 Hrs, Bias @ T <sub>j</sub> =125°C
PCT	JESD-22, A102	168 Hrs, 100%RH, 2atm, 121°C
TCT	JESD-22, A104	500 Cycles, -65°C~150°C
HBM	MIL-STD-883-3015.7	VHBM 2KV
MM	JESD-22, A115	VMM 200V
Latch-Up	JESD 78	10ms, 1 <sub>tr</sub> 100mA

**Customer Service**

**Anpec Electronics Corp.**

Head Office :

No.6, Dusing 1st Road, SBIP,  
Hsin-Chu, Taiwan, R.O.C.  
Tel : 886-3-5642000  
Fax : 886-3-5642050

Taipei Branch :

2F, No. 11, Lane 218, Sec 2 Jhongsing Rd.,  
Sindian City, Taipei County 23146, Taiwan  
Tel : 886-2-2910-3838  
Fax : 886-2-2917-3838