

# NTP45N06L, NTB45N06L

## Power MOSFET 45 Amps, 60 Volts, Logic Level N-Channel TO-220 and D<sup>2</sup>PAK

Designed for low voltage, high speed switching applications in power supplies, converters and power motor controls and bridge circuits.

### Features

- Higher Current Rating
- Lower  $R_{DS(on)}$
- Lower  $V_{DS(on)}$
- Lower Capacitances
- Lower Total Gate Charge
- Tighter  $V_{SD}$  Specification
- Lower Diode Reverse Recovery Time
- Lower Reverse Recovery Stored Charge

### Typical Applications

- Power Supplies
- Converters
- Power Motor Controls
- Bridge Circuits

### MAXIMUM RATINGS ( $T_J = 25^\circ\text{C}$ unless otherwise noted)

Rating	Symbol	Value	Unit
Drain-to-Source Voltage	$V_{DSS}$	60	Vdc
Drain-to-Gate Voltage ( $R_{GS} = 10\text{ M}\Omega$ )	$V_{DGR}$	60	Vdc
Gate-to-Source Voltage	$V_{GS}$		Vdc
– Continuous	$V_{GS}$	$\pm 15$	
– Non-Repetitive ( $t_p \leq 10\text{ ms}$ )	$V_{GS}$	$\pm 20$	
Drain Current			
– Continuous @ $T_A = 25^\circ\text{C}$	$I_D$	45	A dc
– Continuous @ $T_A = 100^\circ\text{C}$	$I_D$	30	
– Single Pulse ( $t_p \leq 10\text{ }\mu\text{s}$ )	$I_{DM}$	150	A pk
Total Power Dissipation @ $T_A = 25^\circ\text{C}$	$P_D$	125	W
Derate above $25^\circ\text{C}$		0.83	W/ $^\circ\text{C}$
Total Power Dissipation @ $T_A = 25^\circ\text{C}$ (Note 1.)		3.2	W
Total Power Dissipation @ $T_A = 25^\circ\text{C}$ (Note 2.)		2.4	W
Operating and Storage Temperature Range	$T_J, T_{stg}$	$-55$ to $+175$	$^\circ\text{C}$
Single Pulse Drain-to-Source Avalanche Energy – Starting $T_J = 25^\circ\text{C}$ ( $V_{DD} = 50\text{ Vdc}$ , $V_{GS} = 5.0\text{ Vdc}$ , $L = 0.3\text{ mH}$ $I_L(\text{pk}) = 40\text{ A}$ , $V_{DS} = 60\text{ Vdc}$ , $R_G = 25\text{ }\Omega$ )	$E_{AS}$	240	mJ

1. When surface mounted to an FR4 board using 1" pad size, (Cu Area 1.127 in<sup>2</sup>).
2. When surface mounted to an FR4 board using the minimum recommended pad size, (Cu Area 0.412 in<sup>2</sup>).



ON Semiconductor™

<http://onsemi.com>

**45 AMPERES**  
**60 VOLTS**  
 **$R_{DS(on)} = 28\text{ m}\Omega$**

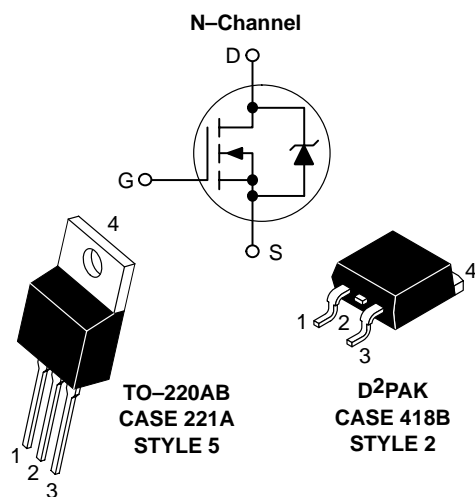

### MARKING DIAGRAMS & PIN ASSIGNMENTS

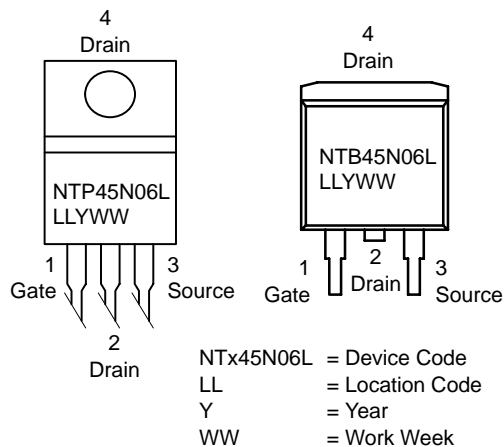

### ORDERING INFORMATION

Device	Package	Shipping
NTP45N06L	TO-220AB	50 Units/Rail
NTB45N06L	D <sup>2</sup> PAK	50 Units/Rail
NTB45N06LT4	D <sup>2</sup> PAK	800/Tape & Reel

# NTP45N06L, NTB45N06L

## MAXIMUM RATINGS (T<sub>J</sub> = 25°C unless otherwise noted)

Rating	Symbol	Value	Unit
Thermal Resistance – Junction-to-Case – Junction-to-Ambient (Note 3.) – Junction-to-Ambient (Note 4.)	R <sub>θJC</sub> R <sub>θJA</sub> R <sub>θJA</sub>	1.2 46.8 63.2	°C/W
Maximum Lead Temperature for Soldering Purposes, 1/8" from case for 10 seconds	T <sub>L</sub>	260	°C

## ELECTRICAL CHARACTERISTICS (T<sub>J</sub> = 25°C unless otherwise noted)

Characteristic	Symbol	Min	Typ	Max	Unit
----------------	--------	-----	-----	-----	------

### OFF CHARACTERISTICS

Drain-to-Source Breakdown Voltage (Note 4.) (V <sub>GS</sub> = 0 Vdc, I <sub>D</sub> = 250 μAdc) Temperature Coefficient (Positive)	V <sub>(BR)DSS</sub>	60 –	67 67.2	– –	Vdc mV/°C
Zero Gate Voltage Drain Current (V <sub>DS</sub> = 60 Vdc, V <sub>GS</sub> = 0 Vdc) (V <sub>DS</sub> = 60 Vdc, V <sub>GS</sub> = 0 Vdc, T <sub>J</sub> = 150°C)	I <sub>DSS</sub>	– –	– –	1.0 10	μAdc
Gate-Body Leakage Current (V <sub>GS</sub> = ±15 Vdc, V <sub>DS</sub> = 0 Vdc)	I <sub>GSS</sub>	–	–	±100	nAdc

### ON CHARACTERISTICS (Note 5.)

Gate Threshold Voltage (Note 5.) (V <sub>DS</sub> = V <sub>GS</sub> , I <sub>D</sub> = 250 μAdc) Threshold Temperature Coefficient (Negative)	V <sub>GS(th)</sub>	1.0 –	1.8 4.7	2.0 –	Vdc mV/°C
Static Drain-to-Source On-Resistance (Note 5.) (V <sub>GS</sub> = 5.0 Vdc, I <sub>D</sub> = 22.5 Adc)	R <sub>DS(on)</sub>	–	23	28	mOhm
Static Drain-to-Source On-Voltage (Note 5.) (V <sub>GS</sub> = 5.0 Vdc, I <sub>D</sub> = 45 Adc) (V <sub>GS</sub> = 5.0 Vdc, I <sub>D</sub> = 22.5 Adc, T <sub>J</sub> = 150°C)	V <sub>DS(on)</sub>	– –	1.03 0.93	1.51 –	Vdc
Forward Transconductance (Note 5.) (V <sub>DS</sub> = 8.0 Vdc, I <sub>D</sub> = 12 Adc)	g <sub>FS</sub>	–	22.8	–	mhos

### DYNAMIC CHARACTERISTICS

Input Capacitance	(V <sub>DS</sub> = 25 Vdc, V <sub>GS</sub> = 0 Vdc, f = 1.0 MHz)	C <sub>iss</sub>	–	1212	1700	pF
Output Capacitance		C <sub>oss</sub>	–	352	480	
Transfer Capacitance		C <sub>rss</sub>	–	90	180	

### SWITCHING CHARACTERISTICS (Note 6.)

Turn-On Delay Time	(V <sub>DD</sub> = 30 Vdc, I <sub>D</sub> = 45 Adc, V <sub>GS</sub> = 5.0 Vdc, R <sub>G</sub> = 9.1 Ω) (Note 5.)	t <sub>d(on)</sub>	–	13	30	ns
Rise Time		t <sub>r</sub>	–	341	680	
Turn-Off Delay Time		t <sub>d(off)</sub>	–	36	75	
Fall Time		t <sub>f</sub>	–	158	320	
Gate Charge	(V <sub>DS</sub> = 48 Vdc, I <sub>D</sub> = 45 Adc, V <sub>GS</sub> = 5.0 Vdc) (Note 5.)	Q <sub>T</sub>	–	23	32	nC
		Q <sub>1</sub>	–	4.6	–	
		Q <sub>2</sub>	–	14.1	–	

### SOURCE-DRAIN DIODE CHARACTERISTICS

Forward On-Voltage	(I <sub>S</sub> = 45 Adc, V <sub>GS</sub> = 0 Vdc) (Note 5.) (I <sub>S</sub> = 45 Adc, V <sub>GS</sub> = 0 Vdc, T <sub>J</sub> = 150°C)	V <sub>SD</sub>	– –	1.01 0.92	1.15 –	Vdc
Reverse Recovery Time	(I <sub>S</sub> = 45 Adc, V <sub>GS</sub> = 0 Vdc, di <sub>S</sub> /dt = 100 A/μs) (Note 5.)	t <sub>rr</sub>	–	56	–	ns
		t <sub>a</sub>	–	30	–	
		t <sub>b</sub>	–	26	–	
Reverse Recovery Stored Charge		Q <sub>RR</sub>	–	0.09	–	μC

3. When surface mounted to an FR4 board using 1" pad size, (Cu Area 1.127 in<sup>2</sup>).

4. When surface mounted to an FR4 board using the minimum recommended pad size, (Cu Area 0.412 in<sup>2</sup>).

5. Pulse Test: Pulse Width ≤ 300 μs, Duty Cycle ≤ 2%.

6. Switching characteristics are independent of operating junction temperatures.

# NTP45N06L, NTB45N06L

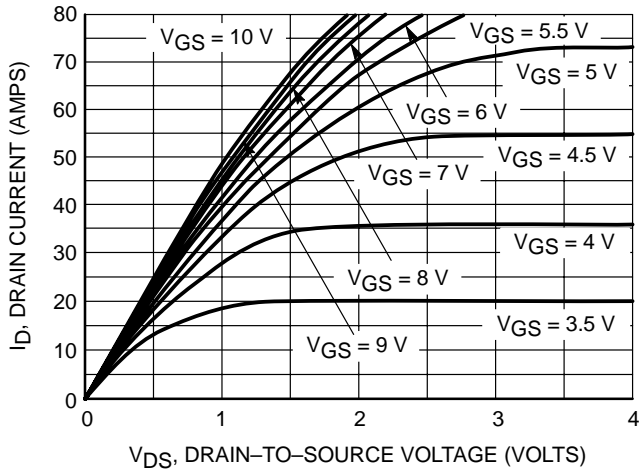

Figure 1. On-Region Characteristics

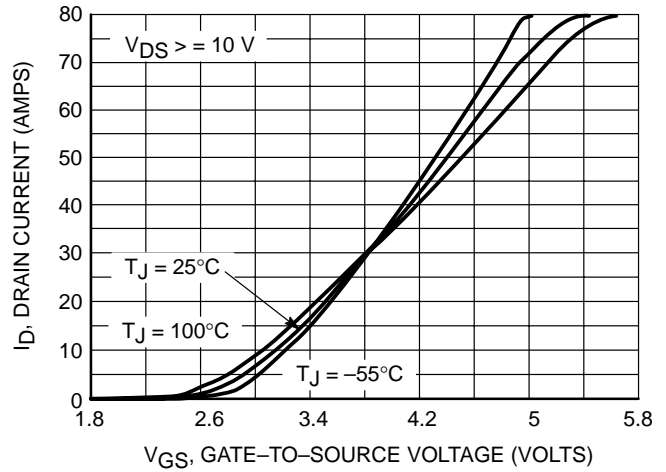

Figure 2. Transfer Characteristics

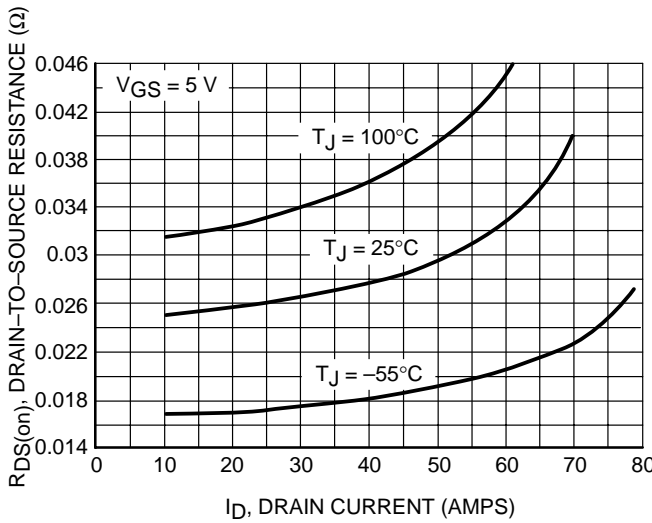

Figure 3. On-Resistance vs. Gate-to-Source Voltage

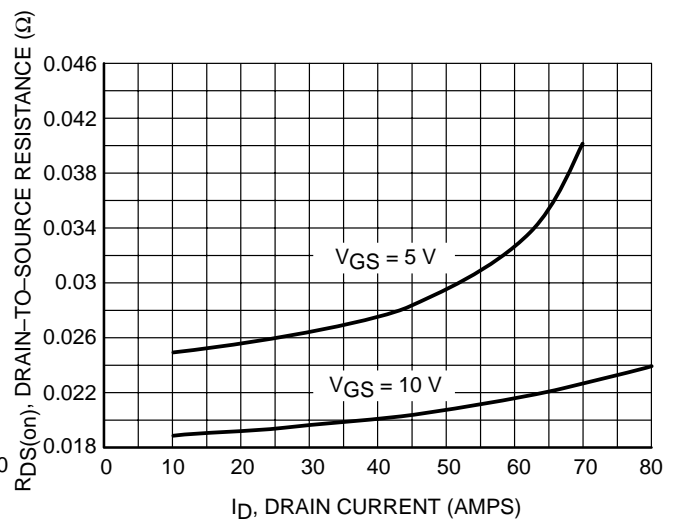

Figure 4. On-Resistance vs. Drain Current and Gate Voltage

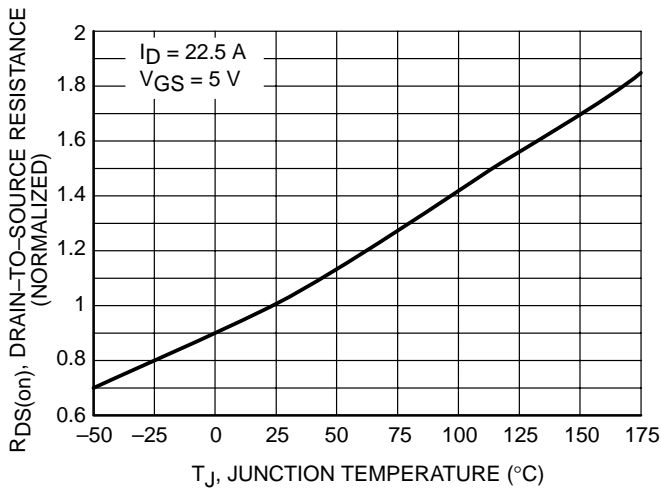

Figure 5. On-Resistance Variation with Temperature

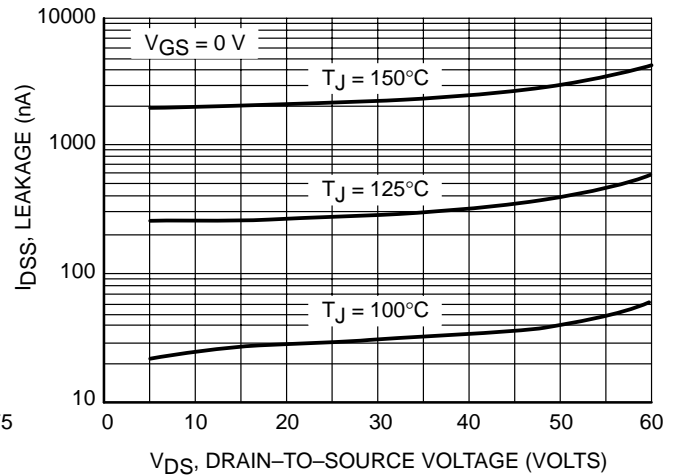
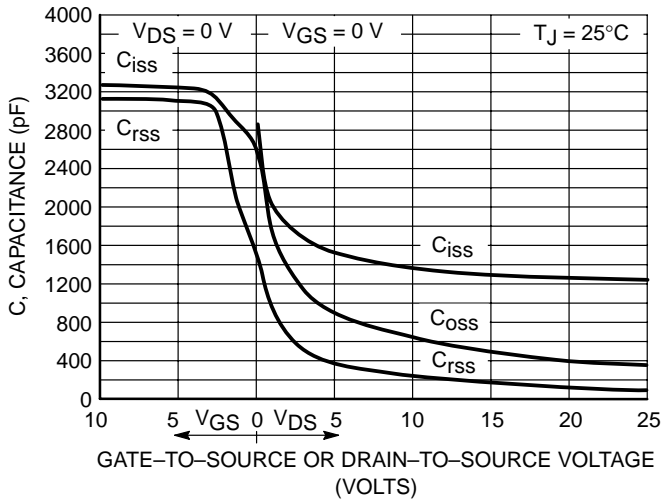
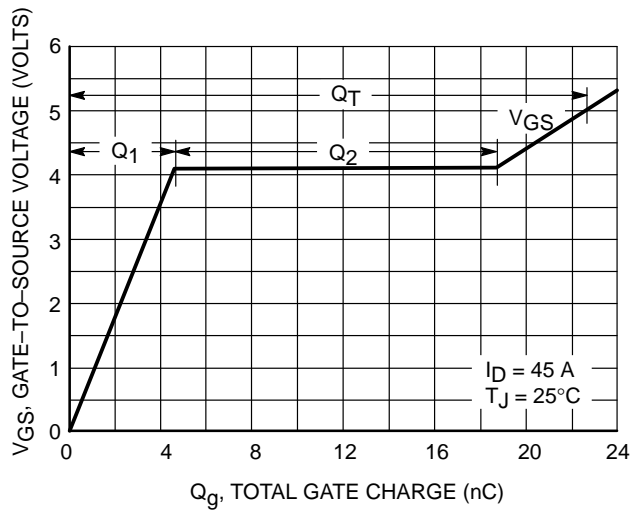

Figure 6. Drain-to-Source Leakage Current vs. Voltage

# NTP45N06L, NTB45N06L



**Figure 7. Capacitance Variation**



**Figure 8. Gate-to-Source and Drain-to-Source Voltage vs. Total Charge**

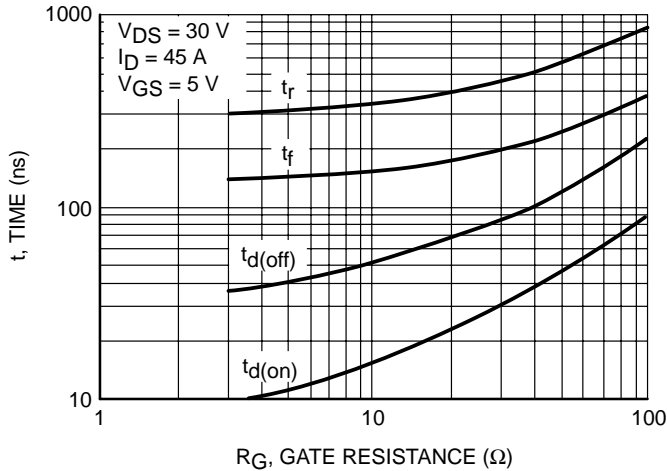

**Figure 9. Resistive Switching Time Variation vs. Gate Resistance**

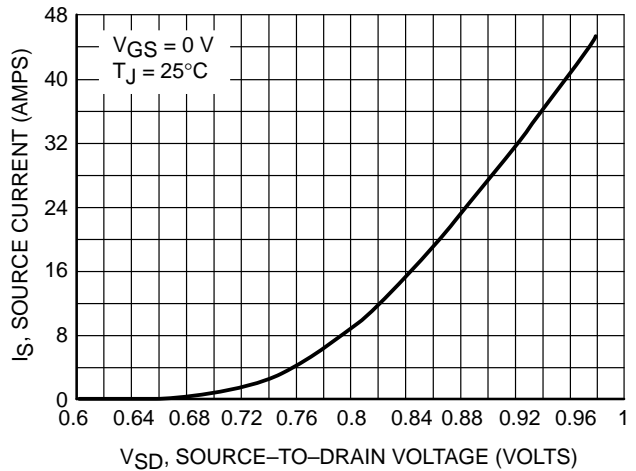

**Figure 10. Diode Forward Voltage vs. Current**

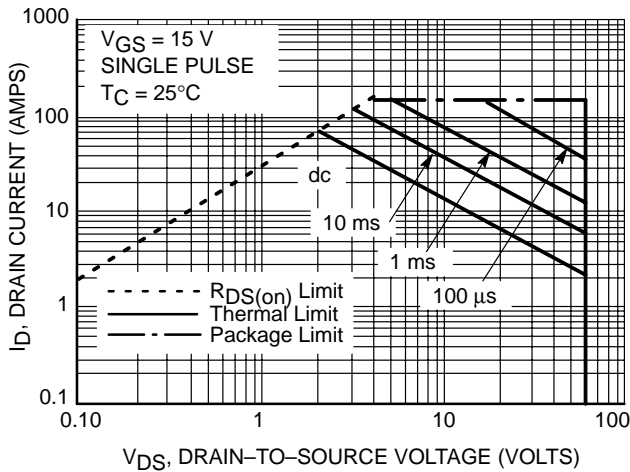

**Figure 11. Maximum Rated Forward Biased Safe Operating Area**

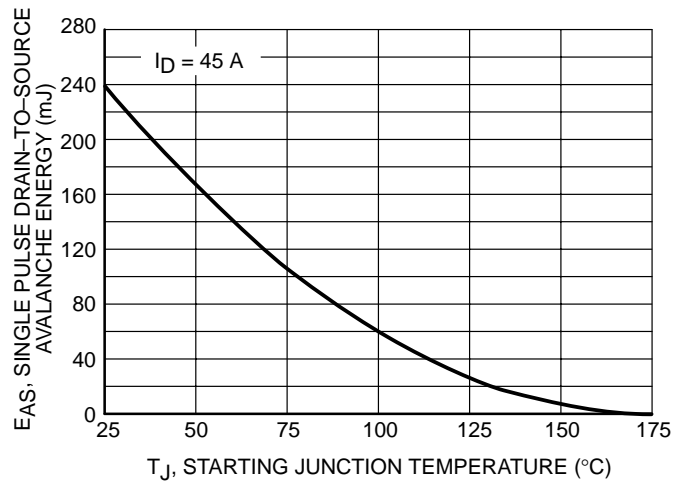

**Figure 12. Maximum Avalanche Energy vs. Starting Junction Temperature**

NTP45N06L, NTB45N06L

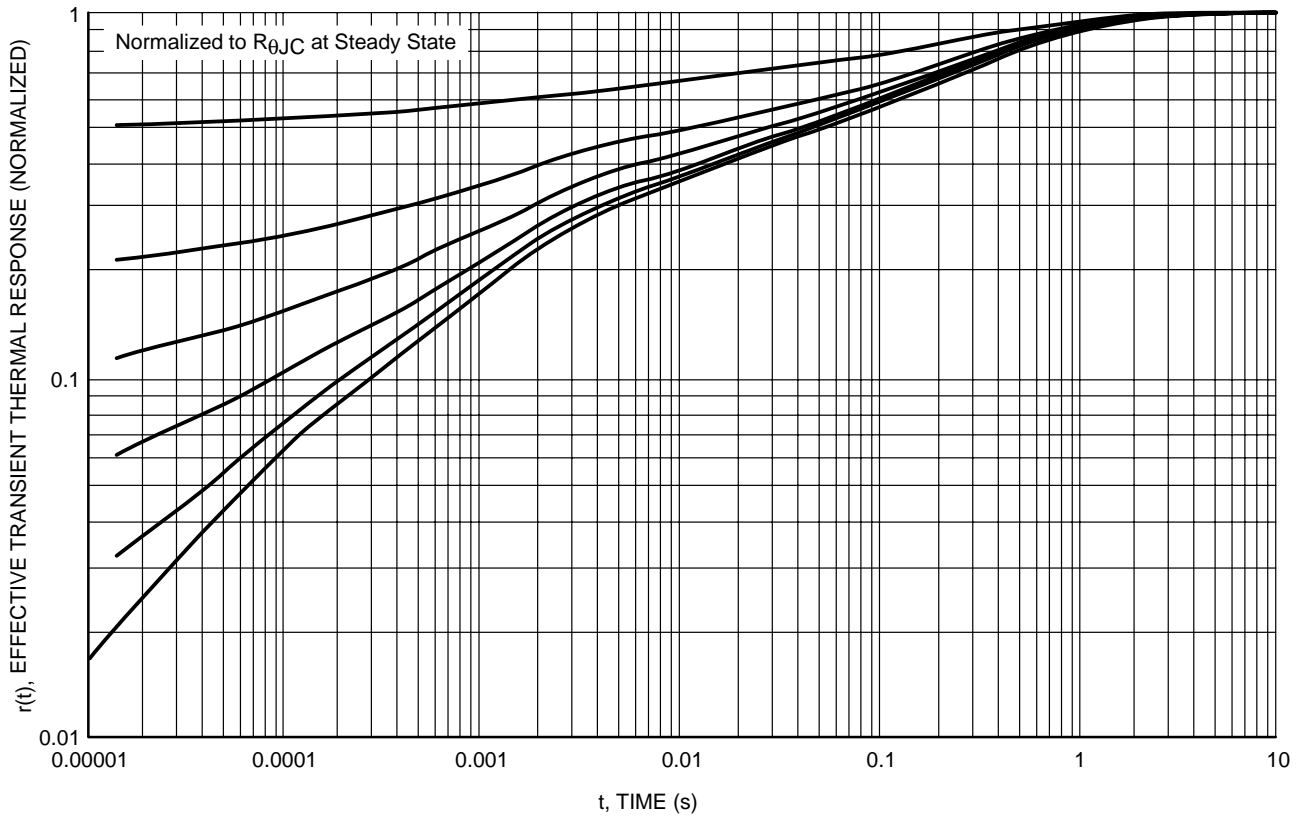

Figure 13. Thermal Response

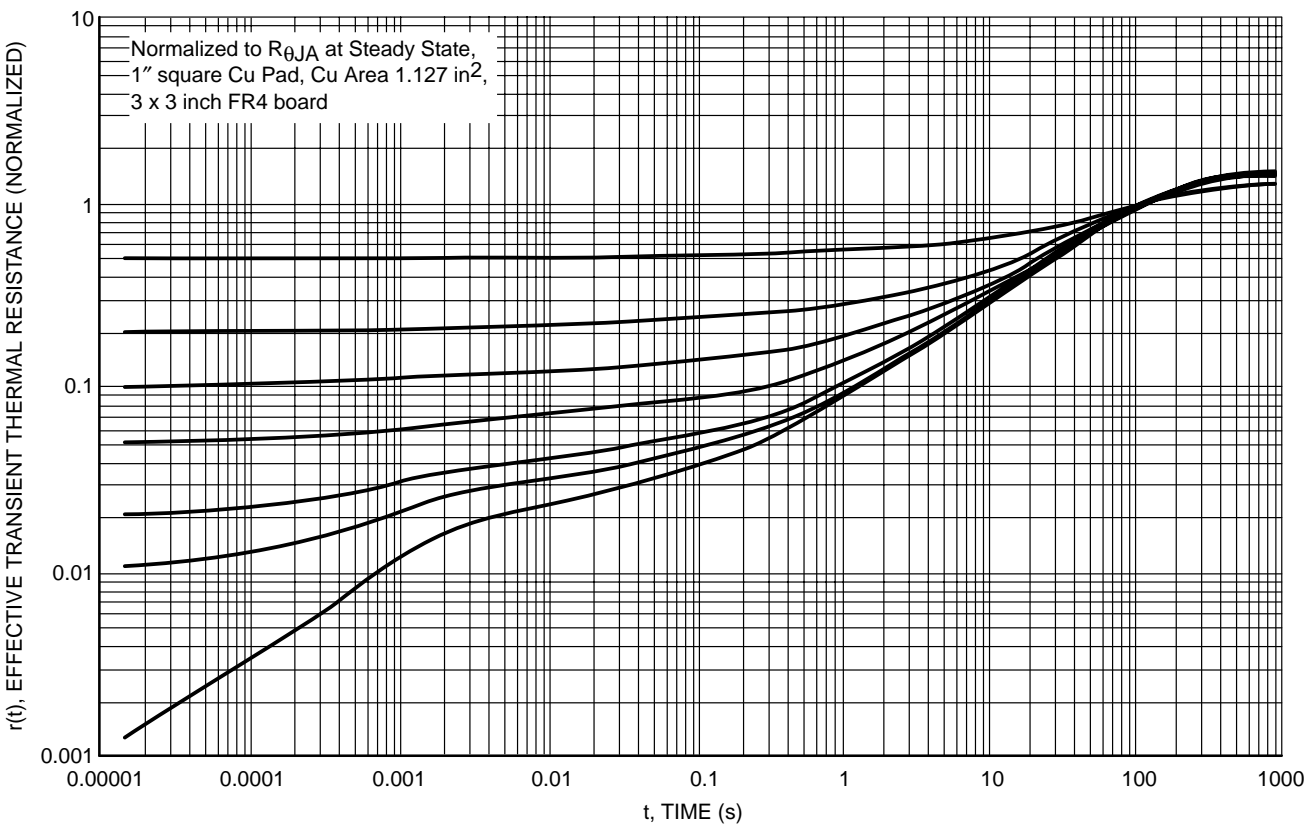

Figure 14. Thermal Response

# NTP45N06L, NTB45N06L

## PACKAGE DIMENSIONS

TO-220 THREE-LEAD  
TO-220AB  
CASE 221A-09  
ISSUE AA



NOTES:

1. DIMENSIONING AND TOLERANCING PER ANSI Y14.5M, 1982.
2. CONTROLLING DIMENSION: INCH.
3. DIMENSION Z DEFINES A ZONE WHERE ALL BODY AND LEAD IRREGULARITIES ARE ALLOWED.

DIM	INCHES		MILLIMETERS	
	MIN	MAX	MIN	MAX
A	0.570	0.620	14.48	15.75
B	0.380	0.405	9.66	10.28
C	0.160	0.190	4.07	4.82
D	0.025	0.035	0.64	0.88
F	0.142	0.147	3.61	3.73
G	0.095	0.105	2.42	2.66
H	0.110	0.155	2.80	3.93
J	0.018	0.025	0.46	0.64
K	0.500	0.562	12.70	14.27
L	0.045	0.060	1.15	1.52
N	0.190	0.210	4.83	5.33
Q	0.100	0.120	2.54	3.04
R	0.080	0.110	2.04	2.79
S	0.045	0.055	1.15	1.39
T	0.235	0.255	5.97	6.47
U	0.000	0.050	0.00	1.27
V	0.045	---	1.15	---
Z	---	0.080	---	2.04

STYLE 5:

- PIN 1. GATE
2. DRAIN
3. SOURCE
4. DRAIN

# NTP45N06L, NTB45N06L

## PACKAGE DIMENSIONS

**D2PAK**  
CASE 418B-03  
ISSUE D

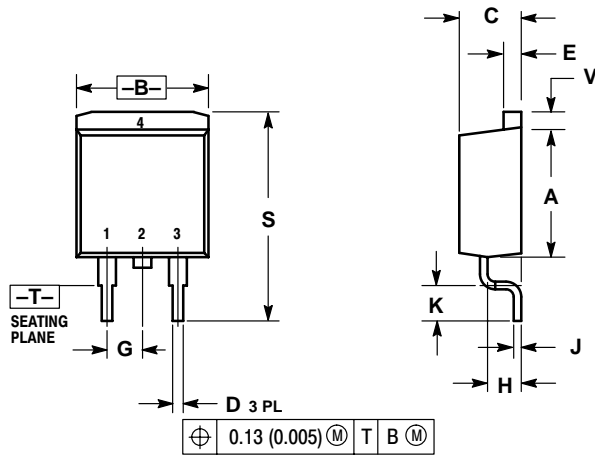

- NOTES:  
1. DIMENSIONING AND TOLERANCING PER ANSI Y14.5M, 1982.  
2. CONTROLLING DIMENSION: INCH.

DIM	INCHES		MILLIMETERS	
	MIN	MAX	MIN	MAX
A	0.340	0.380	8.64	9.65
B	0.380	0.405	9.65	10.29
C	0.160	0.190	4.06	4.83
D	0.020	0.035	0.51	0.89
E	0.045	0.055	1.14	1.40
G	0.100 BSC		2.54 BSC	
H	0.080	0.110	2.03	2.79
J	0.018	0.025	0.46	0.64
K	0.090	0.110	2.29	2.79
S	0.575	0.625	14.60	15.88
V	0.045	0.055	1.14	1.40

- STYLE 2:  
PIN 1. GATE  
2. DRAIN  
3. SOURCE  
4. DRAIN

# NTP45N06L, NTB45N06L

**ON Semiconductor** and  are trademarks of Semiconductor Components Industries, LLC (SCILLC). SCILLC reserves the right to make changes without further notice to any products herein. SCILLC makes no warranty, representation or guarantee regarding the suitability of its products for any particular purpose, nor does SCILLC assume any liability arising out of the application or use of any product or circuit, and specifically disclaims any and all liability, including without limitation special, consequential or incidental damages. "Typical" parameters which may be provided in SCILLC data sheets and/or specifications can and do vary in different applications and actual performance may vary over time. All operating parameters, including "Typicals" must be validated for each customer application by customer's technical experts. SCILLC does not convey any license under its patent rights nor the rights of others. SCILLC products are not designed, intended, or authorized for use as components in systems intended for surgical implant into the body, or other applications intended to support or sustain life, or for any other application in which the failure of the SCILLC product could create a situation where personal injury or death may occur. Should Buyer purchase or use SCILLC products for any such unintended or unauthorized application, Buyer shall indemnify and hold SCILLC and its officers, employees, subsidiaries, affiliates, and distributors harmless against all claims, costs, damages, and expenses, and reasonable attorney fees arising out of, directly or indirectly, any claim of personal injury or death associated with such unintended or unauthorized use, even if such claim alleges that SCILLC was negligent regarding the design or manufacture of the part. SCILLC is an Equal Opportunity/Affirmative Action Employer.

## PUBLICATION ORDERING INFORMATION

### **NORTH AMERICA Literature Fulfillment:**

Literature Distribution Center for ON Semiconductor  
P.O. Box 5163, Denver, Colorado 80217 USA  
**Phone:** 303-675-2175 or 800-344-3860 Toll Free USA/Canada  
**Fax:** 303-675-2176 or 800-344-3867 Toll Free USA/Canada  
**Email:** ONlit@hibbertco.com  
Fax Response Line: 303-675-2167 or 800-344-3810 Toll Free USA/Canada

**N. American Technical Support:** 800-282-9855 Toll Free USA/Canada

**EUROPE:** LDC for ON Semiconductor – European Support

**German Phone:** (+1) 303-308-7140 (Mon-Fri 2:30pm to 7:00pm CET)  
**Email:** ONlit-german@hibbertco.com  
**French Phone:** (+1) 303-308-7141 (Mon-Fri 2:00pm to 7:00pm CET)  
**Email:** ONlit-french@hibbertco.com  
**English Phone:** (+1) 303-308-7142 (Mon-Fri 12:00pm to 5:00pm GMT)  
**Email:** ONlit@hibbertco.com

**EUROPEAN TOLL-FREE ACCESS\*: 00-800-4422-3781**

\*Available from Germany, France, Italy, UK, Ireland

### **CENTRAL/SOUTH AMERICA:**

**Spanish Phone:** 303-308-7143 (Mon-Fri 8:00am to 5:00pm MST)  
**Email:** ONlit-spanish@hibbertco.com  
**Toll-Free from Mexico:** Dial 01-800-288-2872 for Access –  
then Dial 866-297-9322

**ASIA/PACIFIC:** LDC for ON Semiconductor – Asia Support

**Phone:** 303-675-2121 (Tue-Fri 9:00am to 1:00pm, Hong Kong Time)  
**Toll Free from Hong Kong & Singapore:**  
**001-800-4422-3781**  
**Email:** ONlit-asia@hibbertco.com

**JAPAN:** ON Semiconductor, Japan Customer Focus Center  
4-32-1 Nishi-Gotanda, Shinagawa-ku, Tokyo, Japan 141-0031  
**Phone:** 81-3-5740-2700  
**Email:** r14525@onsemi.com

**ON Semiconductor Website:** <http://onsemi.com>

For additional information, please contact your local Sales Representative.