

RF Power Field Effect Transistors

N-Channel Enhancement-Mode Lateral MOSFETs

Designed for W-CDMA and LTE base station applications with frequencies from 2110 to 2170 MHz. Can be used in Class AB and Class C for all typical cellular base station modulation formats.

- Typical Single-Carrier W-CDMA Performance: $V_{DD} = 28$ Volts, $I_{DQ} = 700$ mA, $P_{out} = 24$ Watts Avg., IQ Magnitude Clipping, Channel Bandwidth = 3.84 MHz, Input Signal PAR = 7.5 dB @ 0.01% Probability on CCDF.

Frequency	G_{ps} (dB)	η_D (%)	Output PAR (dB)	ACPR (dBc)
2110 MHz	17.9	33.0	6.4	-38.7
2140 MHz	18.1	33.0	6.4	-38.2
2170 MHz	18.3	33.4	6.3	-37.2

- Capable of Handling 10:1 VSWR, @ 32 Vdc, 2140 MHz, 138 Watts CW ⁽¹⁾ Output Power (3 dB Input Overdrive from Rated P_{out})
- Typical P_{out} @ 1 dB Compression Point \approx 100 Watts CW

Features

- 100% PAR Tested for Guaranteed Output Power Capability
- Characterized with Series Equivalent Large-Signal Impedance Parameters and Common Source S-Parameters
- Internally Matched for Ease of Use
- Integrated ESD Protection
- Greater Negative Gate-Source Voltage Range for Improved Class C Operation
- Designed for Digital Predistortion Error Correction Systems
- Optimized for Doherty Applications
- RoHS Compliant
- In Tape and Reel. R3 Suffix = 250 Units, 56 mm Tape Width, 13 inch Reel. For R5 Tape and Reel option, see p. 14.

MRF8S21100HR3
MRF8S21100HSR3

2110-2170 MHz, 24 W AVG., 28 V
W-CDMA, LTE
LATERAL N-CHANNEL
RF POWER MOSFETs

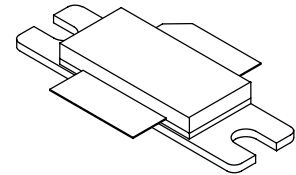

CASE 465-06, STYLE 1
NI-780
MRF8S21100HR3

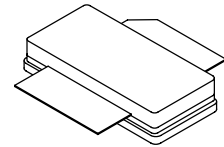

CASE 465A-06, STYLE 1
NI-780S
MRF8S21100HSR3

Table 1. Maximum Ratings

Rating	Symbol	Value	Unit
Drain-Source Voltage	V_{DSS}	-0.5, +65	Vdc
Gate-Source Voltage	V_{GS}	-6.0, +10	Vdc
Operating Voltage	V_{DD}	32, +0	Vdc
Storage Temperature Range	T_{stg}	-65 to +150	°C
Case Operating Temperature	T_C	150	°C
Operating Junction Temperature ^(2,3)	T_J	225	°C
CW Operation @ $T_C = 25^\circ\text{C}$ Derate above 25°C	CW	108 0.57	W W/°C

Table 2. Thermal Characteristics

Characteristic	Symbol	Value ^(3,4)	Unit
Thermal Resistance, Junction to Case Case Temperature 77°C , 24 W CW, 28 Vdc, $I_{DQ} = 700$ mA, 2140 MHz Case Temperature 80°C , 100 W CW ⁽¹⁾ , 28 Vdc, $I_{DQ} = 700$ mA, 2140 MHz	$R_{\theta JC}$	0.48 0.45	°C/W

- Exceeds recommended operating conditions. See CW operation data in Maximum Ratings table.
- Continuous use at maximum temperature will affect MTTF.
- MTTF calculator available at <http://www.freescale.com/rf>. Select Software & Tools/Development Tools/Calculators to access MTTF calculators by product.
- Refer to AN1955, *Thermal Measurement Methodology of RF Power Amplifiers*. Go to <http://www.freescale.com/rf>. Select Documentation/Application Notes - AN1955.

Table 3. ESD Protection Characteristics

Test Methodology	Class
Human Body Model (per JESD22-A114)	2 (Minimum)
Machine Model (per EIA/JESD22-A115)	A (Minimum)
Charge Device Model (per JESD22-C101)	IV (Minimum)

Table 4. Electrical Characteristics ($T_A = 25^\circ\text{C}$ unless otherwise noted)

Characteristic	Symbol	Min	Typ	Max	Unit
----------------	--------	-----	-----	-----	------

Off Characteristics

Zero Gate Voltage Drain Leakage Current ($V_{DS} = 65\text{ Vdc}$, $V_{GS} = 0\text{ Vdc}$)	I_{DSS}	—	—	10	μAdc
Zero Gate Voltage Drain Leakage Current ($V_{DS} = 28\text{ Vdc}$, $V_{GS} = 0\text{ Vdc}$)	I_{DSS}	—	—	1	μAdc
Gate-Source Leakage Current ($V_{GS} = 5\text{ Vdc}$, $V_{DS} = 0\text{ Vdc}$)	I_{GSS}	—	—	1	μAdc

On Characteristics

Gate Threshold Voltage ($V_{DS} = 10\text{ Vdc}$, $I_D = 150\text{ }\mu\text{Adc}$)	$V_{GS(th)}$	1.2	2.0	2.7	Vdc
Gate Quiescent Voltage ($V_{DS} = 28\text{ Vdc}$, $I_D = 700\text{ mAdc}$)	$V_{GS(Q)}$	—	2.7	—	Vdc
Fixture Gate Quiescent Voltage ⁽¹⁾ ($V_{DD} = 28\text{ Vdc}$, $I_D = 700\text{ mAdc}$, Measured in Functional Test)	$V_{GG(Q)}$	4.0	5.4	7.0	Vdc
Drain-Source On-Voltage ($V_{GS} = 10\text{ Vdc}$, $I_D = 1.5\text{ Adc}$)	$V_{DS(on)}$	0.1	0.24	0.3	Vdc

Functional Tests ⁽²⁾ (In Freescale Test Fixture, 50 ohm system) $V_{DD} = 28\text{ Vdc}$, $I_{DQ} = 700\text{ mA}$, $P_{out} = 24\text{ W Avg.}$, $f = 2170\text{ MHz}$, Single-Carrier W-CDMA, IQ Magnitude Clipping, Input Signal PAR = 7.5 dB @ 0.01% Probability on CCDF. ACPR measured in 3.84 MHz Channel Bandwidth @ $\pm 5\text{ MHz}$ Offset.

Power Gain	G_{ps}	17.2	18.3	20.2	dB
Drain Efficiency	η_D	31.0	33.4	—	%
Output Peak-to-Average Ratio @ 0.01% Probability on CCDF	PAR	5.9	6.3	—	dB
Adjacent Channel Power Ratio	ACPR	—	-37.2	-36.0	dBc
Input Return Loss	IRL	—	-12	-7	dB

Typical Broadband Performance (In Freescale Test Fixture, 50 ohm system) $V_{DD} = 28\text{ Vdc}$, $I_{DQ} = 700\text{ mA}$, $P_{out} = 24\text{ W Avg.}$, Single-Carrier W-CDMA, IQ Magnitude Clipping, Input Signal PAR = 7.5 dB @ 0.01% Probability on CCDF. ACPR measured in 3.84 MHz Channel Bandwidth @ $\pm 5\text{ MHz}$ Offset.

Frequency	G_{ps} (dB)	η_D (%)	Output PAR (dB)	ACPR (dBc)	IRL (dB)
2110 MHz	17.9	33.0	6.4	-38.7	-18
2140 MHz	18.1	33.0	6.4	-38.2	-16
2170 MHz	18.3	33.4	6.3	-37.2	-12

- $V_{GG} = 2 \times V_{GS(Q)}$. Parameter measured on Freescale Test Fixture, due to resistive divider network on the board. Refer to Test Circuit schematic.
- Part internally matched both on input and output.

(continued)

Table 4. Electrical Characteristics ($T_A = 25^\circ\text{C}$ unless otherwise noted) (continued)

Characteristic	Symbol	Min	Typ	Max	Unit
Typical Performance (In Freescale Test Fixture, 50 ohm system) $V_{DD} = 28\text{ Vdc}$, $I_{DQ} = 700\text{ mA}$, 2110–2170 MHz Bandwidth					
P_{out} @ 1 dB Compression Point, CW	P1dB	—	100	—	W
IMD Symmetry @ 36 W PEP, P_{out} where IMD Third Order Intermodulation $\cong 30\text{ dBc}$ (Delta IMD Third Order Intermodulation between Upper and Lower Sidebands $> 2\text{ dB}$)	IMD _{sym}	—	40	—	MHz
VBW Resonance Point (IMD Third Order Intermodulation Inflection Point)	VBW _{res}	—	50	—	MHz
Gain Flatness in 60 MHz Bandwidth @ $P_{out} = 24\text{ W Avg.}$	G _F	—	0.4	—	dB
Gain Variation over Temperature (-30°C to $+80^\circ\text{C}$)	ΔG	—	0.011	—	dB/ $^\circ\text{C}$
Output Power Variation over Temperature (-30°C to $+80^\circ\text{C}$) (1)	$\Delta P1\text{dB}$	—	0.005	—	dB/ $^\circ\text{C}$

1. Exceeds recommended operating conditions. See CW operation data in Maximum Ratings table.

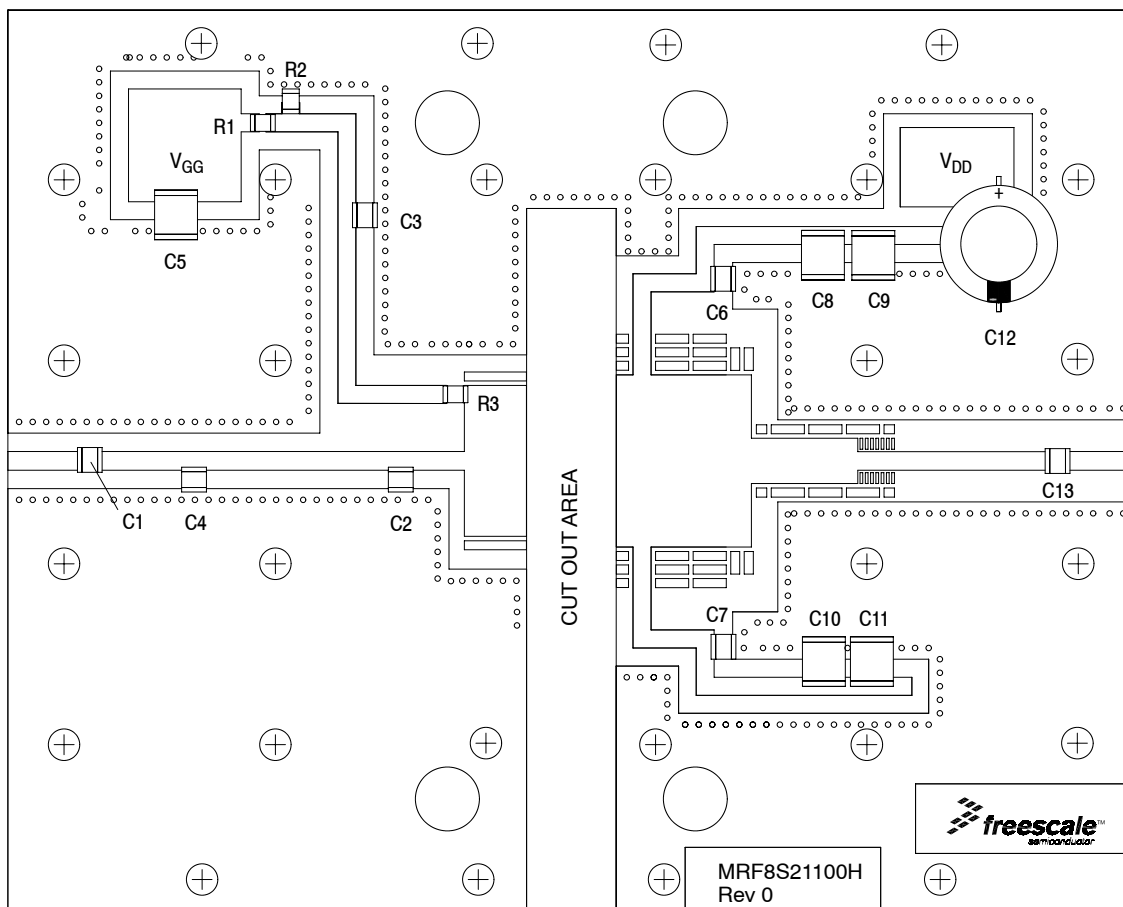
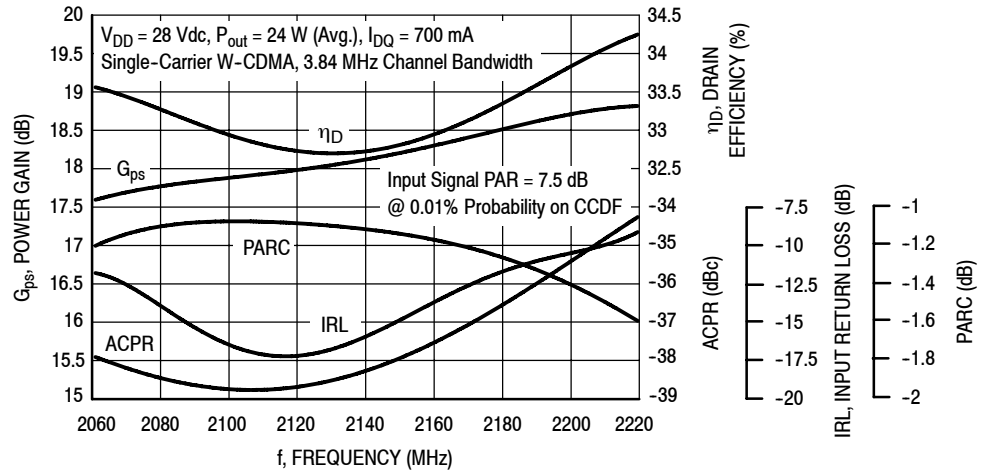

Figure 1. MRF8S21100HR3(HSR3) Test Circuit Component Layout

Table 5. MRF8S21100HR3(HSR3) Test Circuit Component Designations and Values

Part	Description	Part Number	Manufacturer
C1, C3, C6, C7	6.8 pF Chip Capacitors	ATC100B6R8CT500XT	ATC
C2	1.6 pF Chip Capacitor	ATC100B1R6BT500XT	ATC
C4	0.2 pF Chip Capacitor	ATC100B0R2BT500XT	ATC
C5, C8, C9, C10, C11	10 μ F, 50 V Tantalum Capacitors	293D106X9050E2TE3	Vishay
C12	220 μ F, 50 V Electrolytic Capacitor, Radial	227CKS050M	Illinois Capacitor
C13	5.6 pF Chip Capacitor	ATC100B5R6CT500XT	ATC
R1, R2	2 K Ω , 1/4 W Chip Resistors	CRCW12062K00FKEA	Vishay
R3	10 Ω , 1/4 W Chip Resistor	CRCW120610R0JNEA	Vishay
PCB	0.030", $\epsilon_r = 2.55$	AD255A	Arlon

TYPICAL CHARACTERISTICS



**Figure 2. Output Peak-to-Average Ratio Compression (PARC)
Broadband Performance @ $P_{out} = 24$ Watts Avg.**

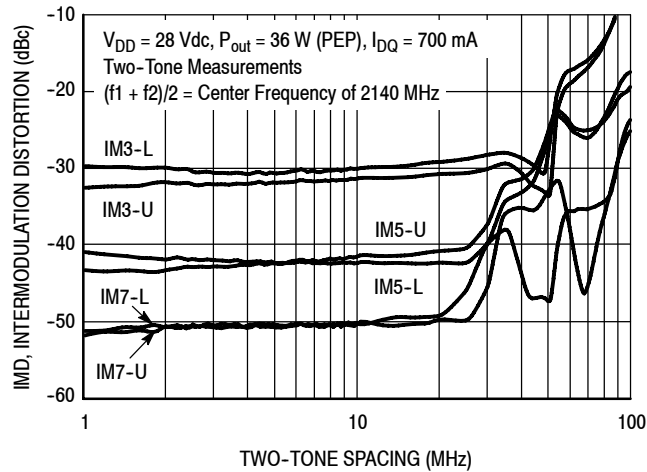

**Figure 3. Intermodulation Distortion Products
versus Two-Tone Spacing**

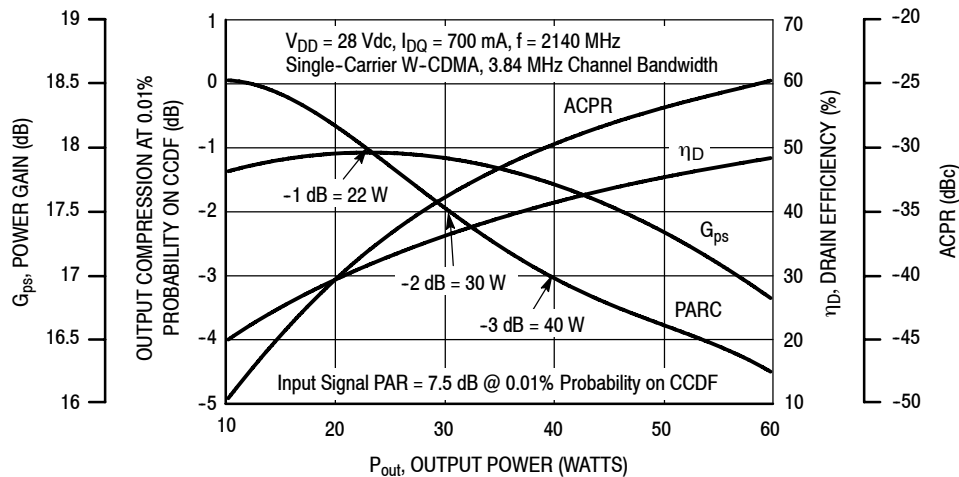

**Figure 4. Output Peak-to-Average Ratio
Compression (PARC) versus Output Power**

TYPICAL CHARACTERISTICS

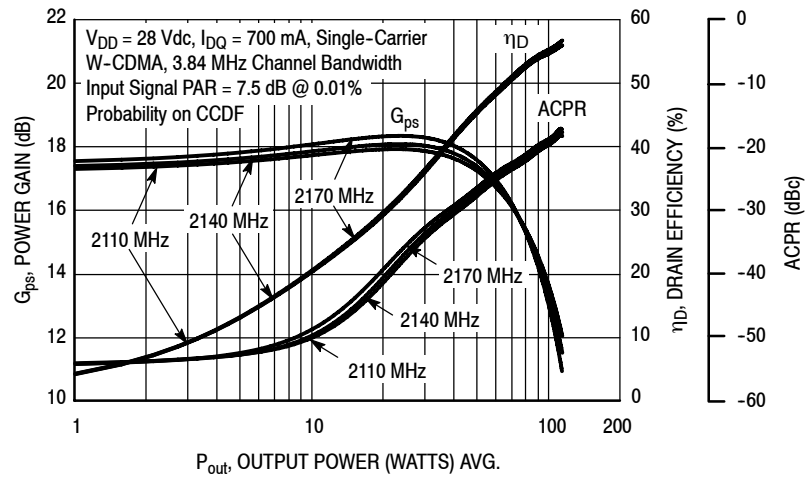

Figure 5. Single-Carrier W-CDMA Power Gain, Drain Efficiency and ACPR versus Output Power

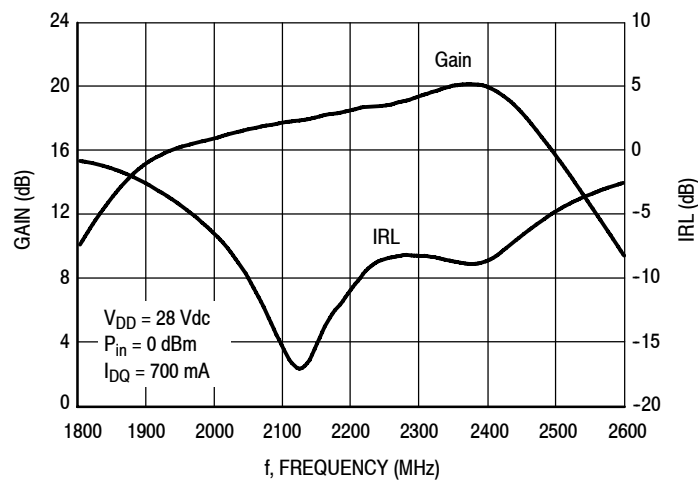

Figure 6. Broadband Frequency Response

W-CDMA TEST SIGNAL

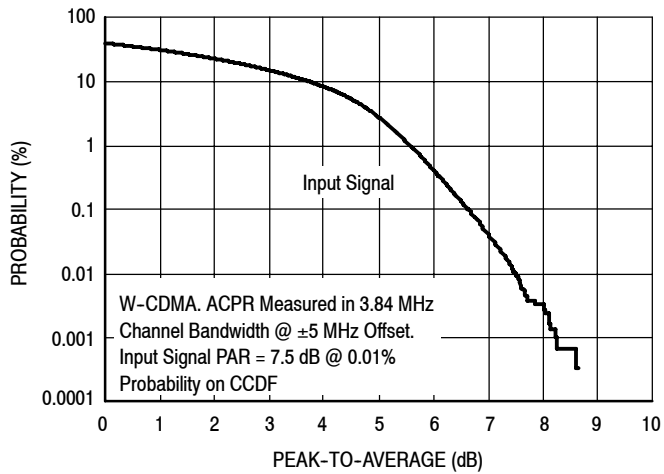

Figure 7. CCDF W-CDMA IQ Magnitude Clipping, Single-Carrier Test Signal

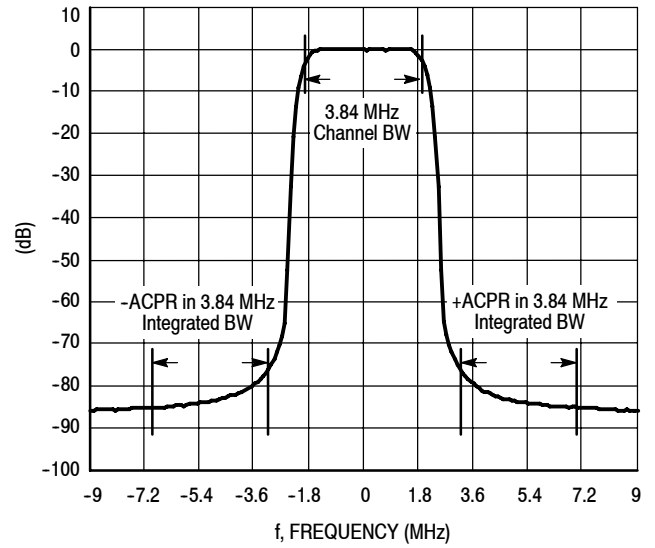

Figure 8. Single-Carrier W-CDMA Spectrum

$V_{DD} = 28 \text{ Vdc}$, $I_{DQ} = 700 \text{ mA}$, $P_{out} = 24 \text{ W Avg.}$

f MHz	Z_{source} Ω	Z_{load} Ω
2060	4.41 - j6.05	3.03 - j3.64
2080	4.38 - j5.67	2.96 - j3.45
2100	4.33 - j5.29	2.89 - j3.26
2120	4.33 - j4.91	2.83 - j3.10
2140	4.33 - j4.54	2.75 - j2.94
2160	4.33 - j4.17	2.69 - j2.75
2180	4.31 - j3.80	2.62 - j2.50
2200	4.32 - j3.39	2.65 - j2.24
2220	4.35 - j2.99	2.67 - j2.04

Z_{source} = Test circuit impedance as measured from gate to ground.

Z_{load} = Test circuit impedance as measured from drain to ground.

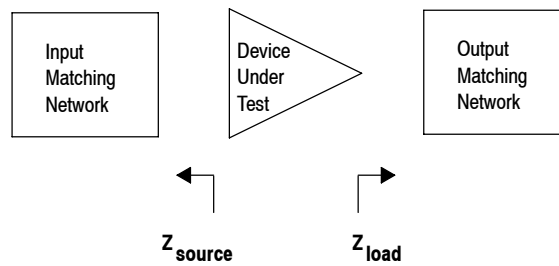
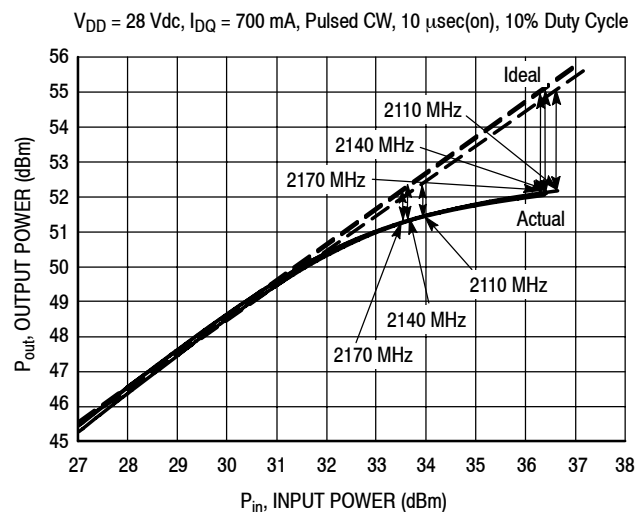

Figure 9. Series Equivalent Source and Load Impedance

ALTERNATIVE PEAK TUNE LOAD PULL CHARACTERISTICS



f (MHz)	P1dB		P3dB	
	Watts	dBm	Watts	dBm
2110	141	51.5	166	52.2
2140	141	51.5	162	52.1
2170	138	51.4	158	52.0

Test Impedances per Compression Level

f (MHz)		Z_{source} Ω	Z_{load} Ω
2110	P1dB	$3.50 - j7.47$	$1.65 - j3.64$
2140	P1dB	$4.21 - j7.53$	$1.57 - j3.70$
2170	P1dB	$6.39 - j8.09$	$1.66 - j3.68$

**Figure 10. Pulsed CW Output Power
versus Input Power @ 28 V**

PACKAGE DIMENSIONS

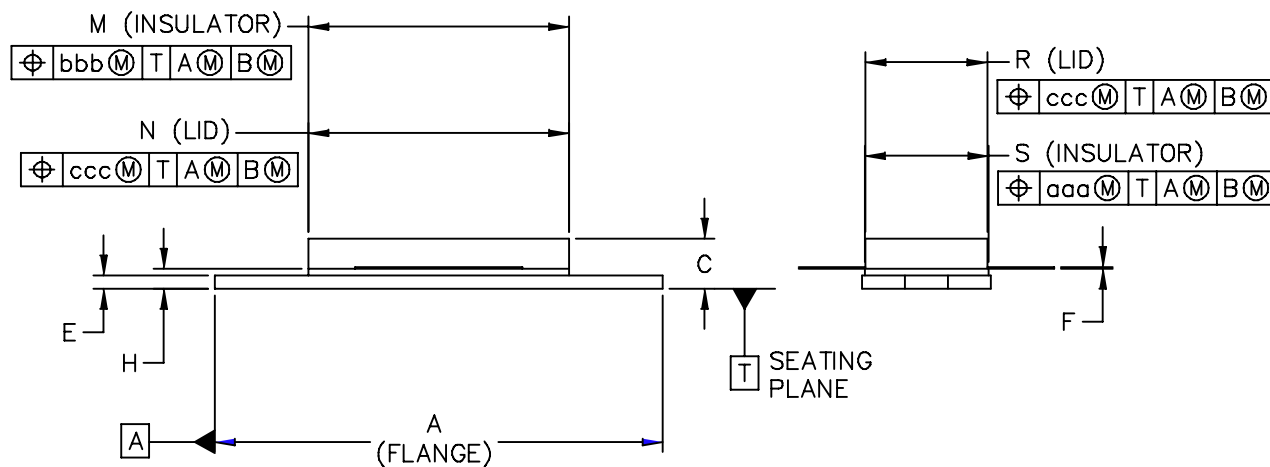
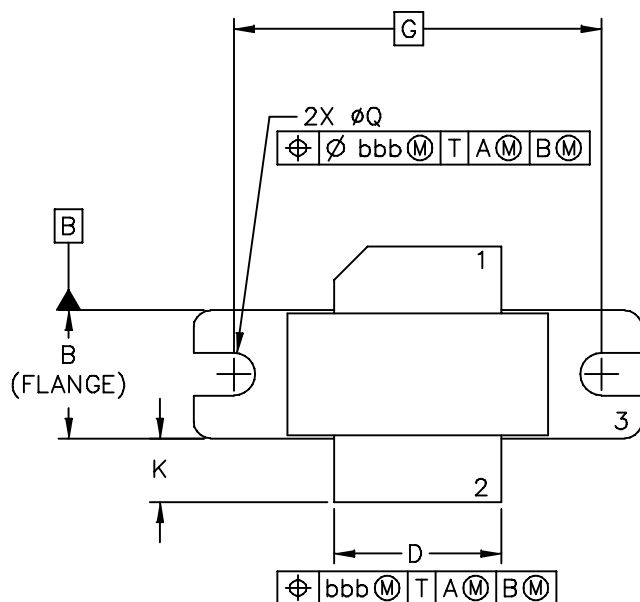

© FREESCALE SEMICONDUCTOR, INC. ALL RIGHTS RESERVED.		MECHANICAL OUTLINE		PRINT VERSION NOT TO SCALE	
TITLE: NI-780		DOCUMENT NO: 98ASB15607C		REV: G	
		CASE NUMBER: 465-06		31 MAR 2005	
		STANDARD: NON-JEDEC			

NOTES:

1. DIMENSIONING AND TOLERANCING PER ANSI Y14.5M–1994.
2. CONTROLLING DIMENSION: INCH.
3. DELETED
4. DIMENSION H IS MEASURED .030 (.762) AWAY FROM PACKAGE BODY.

STYLE 1:

- PIN 1. DRAIN
2. GATE
3. SOURCE

DIM	INCH MIN MAX	MILLIMETER MIN MAX	DIM	INCH MIN MAX	MILLIMETER MIN MAX
A	1.335 – 1.345	33.91 – 34.16	R	.365 – .375	9.27 – 9.53
B	.380 – .390	9.65 – 9.91	S	.365 – .375	9.27 – 9.52
C	.125 – .170	3.18 – 4.32	aaa	– .005 –	– 0.127 –
D	.495 – .505	12.57 – 12.83	bbb	– .010 –	– 0.254 –
E	.035 – .045	0.89 – 1.14	ccc	– .015 –	– 0.381 –
F	.003 – .006	0.08 – 0.15	–	– – –	– – –
G	1.100 BSC	27.94 BSC	–	– – –	– – –
H	.057 – .067	1.45 – 1.7	–	– – –	– – –
K	.170 – .210	4.32 – 5.33	–	– – –	– – –
M	.774 – .786	19.66 – 19.96	–	– – –	– – –
N	.772 – .788	19.6 – 20	–	– – –	– – –
Q	Ø.118 – Ø.138	Ø3 – Ø3.51	–	– – –	– – –
© FREESCALE SEMICONDUCTOR, INC. ALL RIGHTS RESERVED.		MECHANICAL OUTLINE		PRINT VERSION NOT TO SCALE	
TITLE: NI–780			DOCUMENT NO: 98ASB15607C		REV: G
			CASE NUMBER: 465–06		31 MAR 2005
			STANDARD: NON–JEDEC		

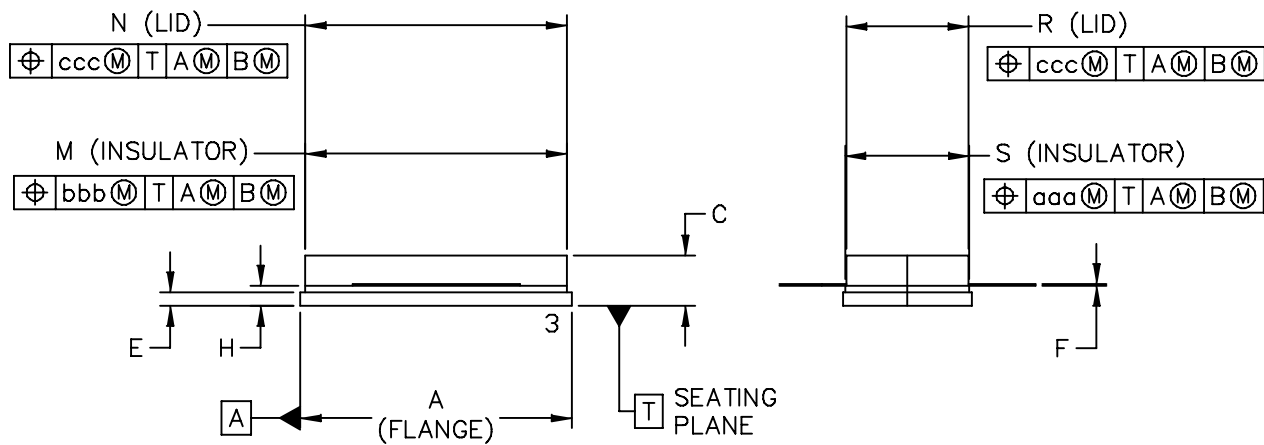

© FREESCALE SEMICONDUCTOR, INC. ALL RIGHTS RESERVED.		MECHANICAL OUTLINE		PRINT VERSION NOT TO SCALE	
TITLE: NI-780S			DOCUMENT NO: 98ASB16718C		REV: H
			CASE NUMBER: 465A-06		31 MAR 2005
			STANDARD: NON-JEDEC		

NOTES:

1. DIMENSIONING AND TOLERANCING PER ANSI Y14.5M–1994.
2. CONTROLLING DIMENSION: INCH.
3. DELETED
4. DIMENSION H IS MEASURED .030 (0.762) AWAY FROM PACKAGE BODY.

STYLE 1:

- PIN 1. DRAIN
2. GATE
3. SOURCE

INCH			MILLIMETER			INCH			MILLIMETER		
DIM	MIN	MAX	MIN	MAX	DIM	MIN	MAX	MIN	MAX		
A	.805	— .815	20.45	— 20.7	U	—	— .040	—	— 1.02		
B	.380	— .390	9.65	— 9.91	Z	—	— .030	—	— 0.76		
C	.125	— .170	3.18	— 4.32	aaa	—	.005 —	—	0.127 —		
D	.495	— .505	12.57	— 12.83	bbb	—	.010 —	—	0.254 —		
E	.035	— .045	0.89	— 1.14	ccc	—	.015 —	—	0.381 —		
F	.003	— .006	0.08	— 0.15	—	—	— —	—	— —		
H	.057	— .067	1.45	— 1.7	—	—	— —	—	— —		
K	.170	— .210	4.32	— 5.33	—	—	— —	—	— —		
M	.774	— .786	19.61	— 20.02	—	—	— —	—	— —		
N	.772	— .788	19.61	— 20.02	—	—	— —	—	— —		
R	.365	— .375	9.27	— 9.53	—	—	— —	—	— —		
S	.365	— .375	9.27	— 9.52	—	—	— —	—	— —		
© FREESCALE SEMICONDUCTOR, INC. ALL RIGHTS RESERVED.				MECHANICAL OUTLINE			PRINT VERSION NOT TO SCALE				
TITLE: NI—780S					DOCUMENT NO: 98ASB16718C				REV: H		
					CASE NUMBER: 465A—06				31 MAR 2005		
					STANDARD: NON—JEDEC						

PRODUCT DOCUMENTATION AND SOFTWARE

Refer to the following documents, tools and software to aid your design process.

Application Notes

- AN1955: Thermal Measurement Methodology of RF Power Amplifiers

Engineering Bulletins

- EB212: Using Data Sheet Impedances for RF LDMOS Devices

Software

- Electromigration MTTF Calculator
- RF High Power Model
- .s2p File

For Software, do a Part Number search at <http://www.freescale.com>, and select the "Part Number" link. Go to the Software & Tools tab on the part's Product Summary page to download the respective tool.

R5 TAPE AND REEL OPTION

R5 Suffix = 50 Units, 56 mm Tape Width, 13 inch Reel.

The R5 tape and reel option for MRF8S21100H and MRF8S21100HS parts will be available for 2 years after release of MRF8S21100H and MRF8S21100HS. Freescale Semiconductor, Inc. reserves the right to limit the quantities that will be delivered in the R5 tape and reel option. At the end of the 2 year period customers who have purchased these devices in the R5 tape and reel option will be offered MRF8S21100H and MRF8S21100HS in the R3 tape and reel option.

REVISION HISTORY

The following table summarizes revisions to this document.

Revision	Date	Description
0	Oct. 2010	<ul style="list-style-type: none">• Initial Release of Data Sheet
1	Mar. 2011	<ul style="list-style-type: none">• Corrected $V_{GG(Q)} V_{DD}$ value from 30 Vdc to 28 Vdc in On Characteristics table to reflect actual test measurement condition, p. 2

How to Reach Us:

Home Page:

www.freescale.com

Web Support:

<http://www.freescale.com/support>

USA/Europe or Locations Not Listed:

Freescale Semiconductor, Inc.
Technical Information Center, EL516
2100 East Elliot Road
Tempe, Arizona 85284
1-800-521-6274 or +1-480-768-2130
www.freescale.com/support

Europe, Middle East, and Africa:

Freescale Halbleiter Deutschland GmbH
Technical Information Center
Schatzbogen 7
81829 Muenchen, Germany
+44 1296 380 456 (English)
+46 8 52200080 (English)
+49 89 92103 559 (German)
+33 1 69 35 48 48 (French)
www.freescale.com/support

Japan:

Freescale Semiconductor Japan Ltd.
Headquarters
ARCO Tower 15F
1-8-1, Shimo-Meguro, Meguro-ku,
Tokyo 153-0064
Japan
0120 191014 or +81 3 5437 9125
support.japan@freescale.com

Asia/Pacific:

Freescale Semiconductor China Ltd.
Exchange Building 23F
No. 118 Jianguo Road
Chaoyang District
Beijing 100022
China
+86 10 5879 8000
support.asia@freescale.com

For Literature Requests Only:

Freescale Semiconductor Literature Distribution Center
1-800-441-2447 or +1-303-675-2140
Fax: +1-303-675-2150
LDCForFreescaleSemiconductor@hibbertgroup.com

Information in this document is provided solely to enable system and software implementers to use Freescale Semiconductor products. There are no express or implied copyright licenses granted hereunder to design or fabricate any integrated circuits or integrated circuits based on the information in this document.

Freescale Semiconductor reserves the right to make changes without further notice to any products herein. Freescale Semiconductor makes no warranty, representation or guarantee regarding the suitability of its products for any particular purpose, nor does Freescale Semiconductor assume any liability arising out of the application or use of any product or circuit, and specifically disclaims any and all liability, including without limitation consequential or incidental damages. "Typical" parameters that may be provided in Freescale Semiconductor data sheets and/or specifications can and do vary in different applications and actual performance may vary over time. All operating parameters, including "Typicals", must be validated for each customer application by customer's technical experts. Freescale Semiconductor does not convey any license under its patent rights nor the rights of others. Freescale Semiconductor products are not designed, intended, or authorized for use as components in systems intended for surgical implant into the body, or other applications intended to support or sustain life, or for any other application in which the failure of the Freescale Semiconductor product could create a situation where personal injury or death may occur. Should Buyer purchase or use Freescale Semiconductor products for any such unintended or unauthorized application, Buyer shall indemnify and hold Freescale Semiconductor and its officers, employees, subsidiaries, affiliates, and distributors harmless against all claims, costs, damages, and expenses, and reasonable attorney fees arising out of, directly or indirectly, any claim of personal injury or death associated with such unintended or unauthorized use, even if such claim alleges that Freescale Semiconductor was negligent regarding the design or manufacture of the part.

Freescale™ and the Freescale logo are trademarks of Freescale Semiconductor, Inc. All other product or service names are the property of their respective owners.

© Freescale Semiconductor, Inc. 2010-2011. All rights reserved.

