

- ◆ 2ch DC/DC Controller (Step-down + Step-down)
- ◆ Input Voltage Range 2.0V ~ 10.0V
- ◆ Output Voltage Externally Set-Up
- ◆ Switching Frequency 300kHz (±15%)
- ◆ Maximum Duty Cycle 100%
- ◆ PWM, PWM/PFM Switching Control
- ◆ High Efficiency Step-down 92% (Typ.)
- ◆ Small MSOP-10 package

### General Description

The XC9503 series are PWM controlled, PWM/PFM automatic switching controlled, multi-functional, 2 channel step-down DC/DC controller ICs. Since the series has a built-in 0.9V reference voltage (accuracy ±2%), 0.9V to 6.0V can be set using external components. With a 300kHz frequency, the size of the external components can be reduced. Switching frequencies of 180kHz & 500kHz are also available as custom-designed products.

The control of the XC9503 series can be switched between PWM control and PWM/PFM automatic switching control using external signals. Control switches from PWM to PFM during light loads when automatic switching is selected and the series is highly efficient from light loads through to large output currents.

Noise is easily reduced with PWM control since the frequency is fixed. The series gives freedom to select control suited to the application. Soft-start time is internally set to 10msec and offers protection against in-rush currents when the power is switched on and also protects against voltage overshoot.

### Applications

- PDAs
- Palm Top Computers
- Digital Cameras
- Various Multi-Function Power Supplies

### Features

Input Voltage Range	: 2.0V ~ 10V
Power Supply Voltage Range	: 2.0V ~ 10V
Output Voltage Range	: 0.9V ~ 6.0V
	Can be set freely with 0.9V (±2.0%) of reference voltage supply and external components.
Oscillation Frequency	: 300kHz ±15%
	(180kHz, 500kHz custom)
Output Current	: more than 1000mA (VIN=5.0V, VOUT=3.3V)
Stand-By Function	: 3.0μA (MAX.)
Package	: MSOP-10
Soft-Start Time	: 10 ms (internally set)

### Typical Performance Characteristics

#### XC9503B093A (300kHz, VOUT1:3.3V)

L1=22μH(CDRH5D28), CL1=47μF(Tantalum)  
SD1:MA2Q737, Tr1:XP162A1355P

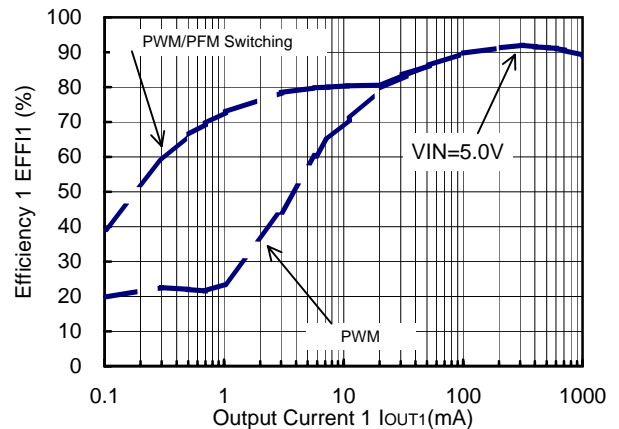

### Typical Application Circuit

#### XC9503B093A Input :

VOUT① : 3.3V, VOUT② : 1.8V

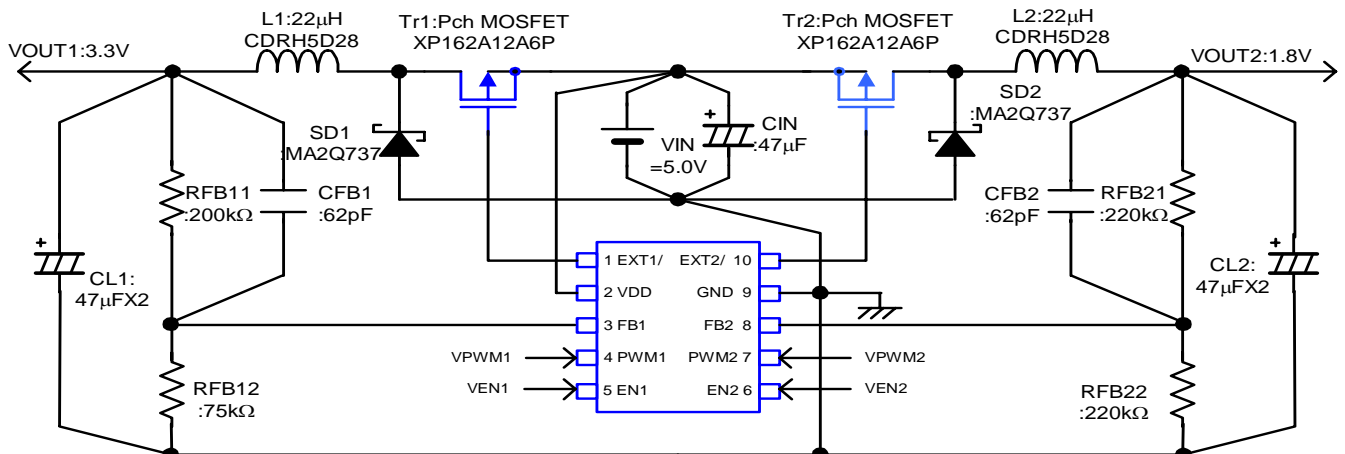

### ■ Pin Configuration

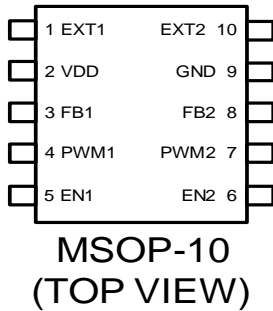

### ■ Pin Assignment

PIN NUMBER	PIN NAME	FUNCTIONS
1	EXT 1	Channel 1: External Transistor Drive Pin <Connected to Pch Power MOSFET Gate>
2	VDD	Supply Voltage
3	FB1	Channel 1 : Output Voltage Monitor Feedback Pin <Threshold value : 0.9V. Output voltage can be set freely by connecting split resistors between VOUT1 and Ground.>
4	PWM1	Channel 1 : PWM/PFM Switching Pin <Control Output 1. PWM control when connected to VDD, PWM / PFM auto switching when connected to Ground. >
5	EN1	Channel 1 : Enable Pin <Connected to Ground when Output 1 is in stand-by mode. Connected to VDD when Output 1 is active. EXT1 is high when in stand-by mode.>
6	EN2	Channel 2 : Enable Pin <Connected to Ground when Output 2 is in stand-by mode. Connected to VDD when Output 2 is active. EXT2/ is high when in stand-by mode.>
7	PWM2	Channel 2 : PWM/PFM Switching Pin <Control Output 2. PWM control when connected to VDD, PWM / PFM auto switching when connected to Ground.>
8	FB2	Channel 2 : Output Voltage Monitor Feedback Pin <Threshold value : 0.9V. Output voltage can be set freely by connecting split resistors between VOUT2 and Ground.>
9	GND	Ground
10	EXT 2	Channel 2 : External Transistor Drive Pin <Connected to Pch Power MOSFET Gate>

### ■ Ordering Information

XC9503①②③④⑤⑥

DESIGNATOR	SYMBOL	DESCRIPTION
①	B	Standard (10 Pin)
②	0	FB Voltage
③	9	0.9V
④		Switching Frequency
	2	180kHz (custom)
	3	300kHz
	5	500kHz (custom)
⑤	A	Package
⑥	R	Embossed Tape
	L	
		MSOP-10
		Standard Feed
		Reverse Feed

### ■ Block Diagram

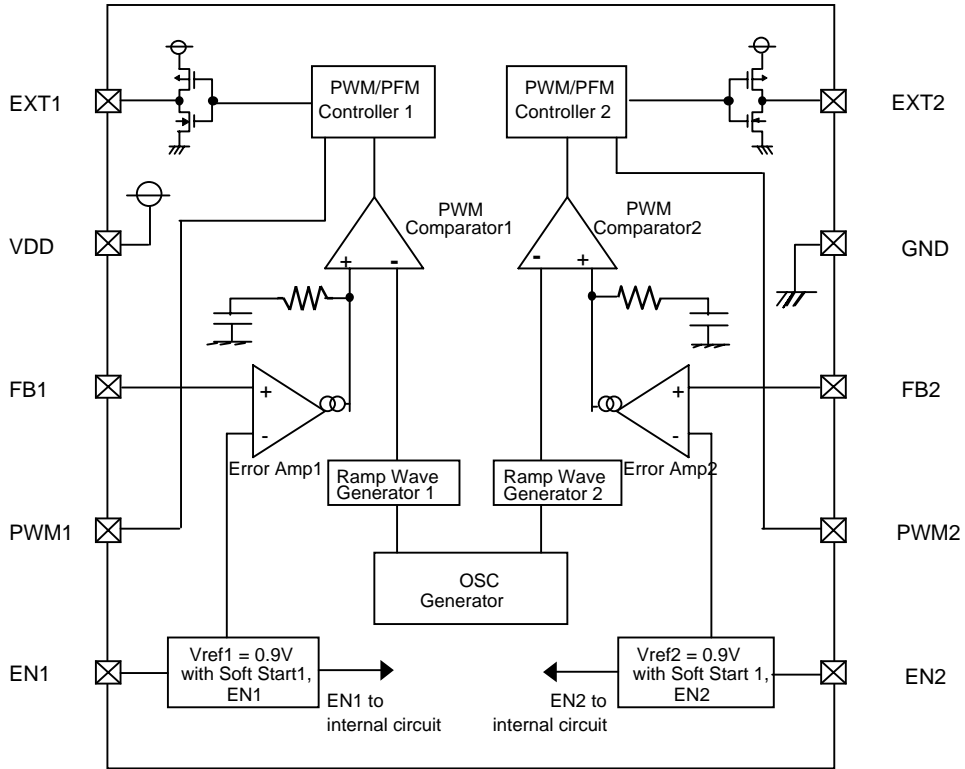

### ■ Absolute Maximum Ratings

Ta=25°C			
PARAMETER	SYMBOL	RATINGS	UNITS
VDD Pin Voltage	VDD	- 0.3 ~ 12	V
FB1, 2 Pin Voltage	VFB	- 0.3 ~ 12	V
EN1, 2 Pin Voltage	VEN	- 0.3 ~ 12	V
PWM1,2 Pin Voltage	VPWM	- 0.3 ~ 12	V
EXT1, 2 Pin Voltage	VEXT	- 0.3 ~ VDD + 0.3	V
EXT1, 2 Pin Current	IEXT	±100	mA
Power Dissipation	Pd	150	mW
Operating Ambient Temperature	Topr	- 40 ~ + 85	°C
Storage Temperature	Tstg	- 55 ~ +125	°C

\* Voltage goes to Ground.

### ■ Electrical Characteristics XC9503B092A

#### Common Characteristics

Ta=25°C

PARAMETER	SYMBOL	CONDITIONS	MIN.	TYP.	MAX.	UNITS	TEST CIRCUIT	
Supply Voltage	VDD		2.0	-	10.0	V	①	
Max. Input Voltage	VIN		10.0	-	-	V	①	
Output Voltage Range (note 1)	VOUTSET	VIN ≥ 2.0V, IOU1, 2=1mA	VOUT1	0.9	-	10.0	V	①
			VOUT2	0.9	-	10.0	V	
Supply Current 1	IDD1	FB1, 2=0V	-	60	120	μA	②	
Supply Current 1-1	IDD1-1	EN1=3.0V, EN2=0V, FB1=0V	-	50	110	μA	②	
		EN2=3.0V, EN1=0V, FB2=0V						
Supply Current 1-2	IDD1-2	FB1=0V, FB2=1.0V	-	60	130	μA	②	
		FB1=1.0V, FB2=0V						
Supply Current 2	IDD2	FB1, 2=1.0V	-	60	140	μA	②	
Stand-by Current	ISTB	Same as IDD1, EN1=EN2=0V	-	1.0	3.0	μA	②	
Switching Frequency	FOSC	Same as IDD1	153	180	207	kHz	②	
EN1,2 "High" Voltage	VENH	FB1,2=0V	0.65	-	-	V	②	
EN1,2 "Low" Voltage	VENL	FB1,2=0V	-	-	0.20	V	②	
EN1,2 "High" Current	IENH	EN1,2=3.0V	-	-	0.50	μA	②	
EN1,2 "Low" Current	IENL	EN1,2=0V, FB1,2=3.0V	-	-	-0.50	μA	②	
PWM1,2 "High" Current	IPWMH	FB1, 2=3.0V, PWM=3.0V	-	-	0.50	μA	②	
PWM1,2 "Low" Current	IPWML	FB1, 2=3.0V, PWM=0V	-	-	-0.50	μA	②	
FB1,2 "High" Current	IFBH	FB1, 2=3.0V	-	-	0.50	μA	②	
FB1,2 "Low" Current	VFBL	FB1, 2=1.0V	-	-	-0.50	μA	②	

Unless otherwise stated, VDD=3.0V, PWM1,2=3.0V, EN1, 2 =3.0V

#### Output 1 Characteristics

#### Step-down Controller

PARAMETER	SYMBOL	CONDITIONS	MIN.	TYP.	MAX.	UNITS	TEST CIRCUIT
FB1 Voltage	VFB1	VIN=3.0V, IOU1=10mA	0.882	0.900	0.918	V	③
Minimum Operation Voltage	VINmin1		-	-	2.0	V	①
Maximum Duty Ratio 1	MAXDTY1	Same as IDD1	100	-	-	%	②
Minimum Duty Ratio 1	MINDTY1	Same as IDD2	-	-	0	%	②
PFM Duty Ratio 1	PFMDTY1	No Load, VPWM1=0V	22	30	38	%	④
Efficiency1 (note 2)	EFFI1	IOU1=250mA	-	92	-	%	④
		P-ch MOSFET : XP162A12A6P					
Soft-Start Time1	TSS1	VOUT1 × 0.95V, EN1=0V → 0.65V	5.0	10.0	20.0	mS	④
EXT1 "High" ON Resistance	REXTBH1	EN1=0, EXT1=VDD-0.4V	-	28	47	Ω	⑤
EXT1 "Low" ON Resistance	REXTBL1	FB2=0V, EXT1=0.4V	-	22	30	Ω	⑤
PWM1 "High" Voltage	VPWMH1	No Load	0.65	-	-	V	④
PWM1 "Low" Voltage	VPWML1	No Load	-	-	0.20	V	④

Unless otherwise stated, VDD=EN1=PWM1=3.0V, PWM2=EN2=GND, EXT2=OPEN, FB2=OPEN, VIN=5.0V

#### Output 2 Characteristics

#### Step-down Controller

PARAMETER	SYMBOL	CONDITIONS	MIN.	TYP.	MAX.	UNITS	TEST CIRCUIT
FB2 Voltage	VFB2	VIN=3.0V, IOU2=10mA	0.882	0.900	0.918	V	⑥
Minimum Operation Voltage	VINmin2		-	-	2.0	V	①
Maximum Duty Ratio 2	MAXDTY2	Same as IDD1	100	-	-	%	②
Minimum Duty Ratio 2	MINDTY2	Same as IDD2	-	-	0	%	②
PFM Duty Ratio 2	PFMDTY2	No Load, VPWM2=0V	22	30	38	%	⑦
Efficiency2 (note 2)	EFFI2	IOU2=250mA	-	92	-	%	⑦
		P-ch MOSFET : XP162A12A6P					
Soft-Start Time 2	TSS2	VOUT2 × 0.95V, EN2=0V → 0.65V	5.0	10.0	20.0	mS	⑦
EXT2 "High" ON Resistance	REXTBH2	EN2=0, EXT2=VDD-0.4V	-	28	47	Ω	⑤
EXT2 "Low" ON Resistance	REXTBL2	FB2=0V, EXT2=0.4V	-	22	30	Ω	⑤
PWM2 "High" Voltage	VPWMH2	No Load	0.65	-	-	V	⑦
PWM2 "Low" Voltage	VPWML2	No Load	-	-	0.20	V	⑦

Unless otherwise stated, VDD=EN2=PWM2=3.0V, PWM1=EN1=GND, EXT1=OPEN, FB1=OPEN, VIN=5.0V

Notes 1) Please be careful not to exceed the breakdown voltage level of the peripheral parts.

2)  $EFFI = \left\{ \frac{(\text{Output voltage}) \times (\text{Output current})}{(\text{Input voltage}) \times (\text{Input Current})} \right\} \times 100$

### ■ Electrical Characteristics XC9503B093A

#### Common Characteristics

Ta=25°C

PARAMETER	SYMBOL	CONDITIONS	MIN.	TYP.	MAX.	UNITS	TEST CIRCUIT	
Supply Voltage	VDD		2.0	-	10.0	V	①	
Max. Input Voltage	VIN		10.0	-	-	V	①	
Output Voltage Range (note 1)	VOUTSET	VIN ≥ 2.0V, IOU1, 2=1mA	VOUT1	0.9	-	10.0	V	①
			VOUT2	0.9	-	10.0	V	
Supply Current 1	IDD1	FB1, 2=0V	-	70	140	μA	②	
Supply Current 1-1	IDD1-1	EN1=3.0V, EN2=0V, FB1=0V	-	60	120	μA	②	
		EN2=3.0V, EN1=0V, FB2=0V						
Supply Current 1-2	IDD1-2	FB1=0V, FB2=1.0V	-	70	150	μA	②	
		FB1=1.0V, FB2=0V						
Supply Current 2	IDD2	FB1, 2=1.0V	-	80	150	μA	②	
Stand-by Current	ISTB	Same as IDD1, EN1=EN2=0V	-	1.0	3.0	μA	②	
Switching Frequency	FOSC	Same as IDD1	255	300	345	kHz	②	
EN1,2 "High" Voltage	VENH	FB1,2=0V	0.65	-	-	V	②	
EN1,2 "Low" Voltage	VENL	FB1,2=0V	-	-	0.20	V	②	
EN1,2 "High" Current	IENH	EN1,2=3.0V	-	-	0.50	μA	②	
EN1,2 "Low" Current	IENL	EN1,2=0V, FB1,2=3.0V	-	-	-0.50	μA	②	
PWM1,2 "High" Current	IPWMH	FB1, 2=3.0V, PWM=3.0V	-	-	0.50	μA	②	
PWM1,2 "Low" Current	IPWML	FB1, 2=3.0V, PWM=0V	-	-	-0.50	μA	②	
FB1,2 "High" Current	IFBH	FB1, 2=3.0V	-	-	0.50	μA	②	
FB1,2 "Low" Current	VFBL	FB1, 2=1.0V	-	-	-0.50	μA	②	

Unless otherwise stated, VDD=3.0V, PWM1,2=3.0V, EN1, 2 =3.0V

#### Output 1 Characteristics

#### Step-down Controller

PARAMETER	SYMBOL	CONDITIONS	MIN.	TYP.	MAX.	UNITS	TEST CIRCUIT
FB1 Voltage	VFB1	VIN=3.0V, IOU1=10mA	0.882	0.900	0.918	V	③
Minimum Operation Voltage	VINmin1		-	-	2.0	V	①
Maximum Duty Ratio 1	MAXDTY1	Same as IDD1	100	-	-	%	②
Minimum Duty Ratio1	MINDTY1	Same as IDD2	-	-	0	%	②
PFM Duty Ratio 1	PFMDTY1	No Load, VPWM1=0V	22	30	38	%	④
Efficiency1 (note 2)	EFF1	IOU1=250mA P-ch MOSFET : XP162A12A6P	-	92	-	%	④
Soft-Start Time1	TSS1	VOUT1 × 0.95V, EN1=0V → 0.65V	5.0	10.0	20.0	mS	④
EXT1 "High" ON Resistance	REXTBH1	EN1=0, EXT1=VDD-0.4V	-	28	47	Ω	⑤
EXT1 "Low" ON Resistance	REXTBL1	FB2=0V, EXT1=0.4V	-	22	30	Ω	⑤
PWM1 "High" Voltage	VPWMH1	No Load	0.65	-	-	V	④
PWM1 "Low" Voltage	VPWML1	No Load	-	-	0.20	V	④

Unless otherwise stated, VDD=EN1=PWM1=3.0V, PWM2=EN2=GND, EXT2=OPEN, FB2=OPEN, VIN=5.0V

#### Output 2 Characteristics

#### Step-down Controller

PARAMETER	SYMBOL	CONDITIONS	MIN.	TYP.	MAX.	UNITS	TEST CIRCUIT
FB2 Voltage	VFB2	VIN=3.0V, IOU2=10mA	0.882	0.900	0.918	V	⑥
Minimum Operation Voltage	VINmin2		-	-	2.0	V	①
Maximum Duty Ratio 2	MAXDTY2	Same as IDD1	100	-	-	%	②
Minimum Duty Ratio 2	MINDTY2	Same as IDD2	-	-	0	%	②
PFM Duty Ratio 2	PFMDTY2	No Load, VPWM2=0V	22	30	38	%	⑦
Efficiency2 (note 2)	EFFI2	IOU2=250mA P-ch MOSFET : XP162A12A6P	-	92	-	%	⑦
Soft-Start Time 2	TSS2	VOUT2 × 0.95V, EN2=0V → 0.65V	5.0	10.0	20.0	mS	⑦
EXT2 "High" ON Resistance	REXTBH2	EN2=0, EXT2=VDD-0.4V	-	28	47	Ω	⑤
EXT2 "Low" ON Resistance	REXTBL2	FB2=0V, EXT2=0.4V	-	22	30	Ω	⑤
PWM2 "High" Voltage	VPWMH2	No Load	0.65	-	-	V	⑦
PWM2 "Low" Voltage	VPWML2	No Load	-	-	0.20	V	⑦

Unless otherwise stated, VDD=EN2=PWM2=3.0V, PWM1=EN1=GND, EXT1=OPEN, FB1=OPEN, VIN=5.0V

Notes 1) Please be careful not to exceed the breakdown voltage level of the peripheral parts.

2)  $EFFI = \{ [(Output\ voltage) \times (Output\ current)] / [(Input\ voltage) \times (Input\ Current)] \} \times 100$

### Electrical Characteristics XC9503B095A

#### Common Characteristics

Ta=25°C

PARAMETER	SYMBOL	CONDITIONS	MIN.	TYP.	MAX.	UNITS	TEST CIRCUIT	
Supply Voltage	VDD		2.0	-	10.0	V	①	
Max. Input Voltage	VIN		10.0	-	-	V	①	
Output Voltage Range (note 1)	Voutset	VIN ≥ 2.0V, IOU1, 2=1mA	VOUT1	0.9	-	10.0	V	①
			VOUT2	0.9	-	10.0	V	
Supply Current 1	IDD1	FB1, 2=0V	-	90	170	μA	②	
Supply Current 1-1	IDD1-1	EN1=3.0V, EN2=0V, FB1=0V	-	80	150	μA	②	
		EN2=3.0V, EN1=0V, FB2=0V						
Supply Current 1-2	IDD1-2	FB1=0V, FB2=1.0V	-	100	180	μA	②	
		FB1=1.0V, FB2=0V						
Supply Current 2	IDD2	FB1, 2=1.0V	-	100	190	μA	②	
Stand-by Current	ISTB	Same as IDD1, EN1=EN2=0V	-	1.0	3.0	μA	②	
Switching Frequency	FOSC	Same as IDD1	425	500	575	kHz	②	
EN1,2 "High" Voltage	VENH	FB1,2=0V	0.65	-	-	V	②	
EN1,2 "Low" Voltage	VENL	FB1,2=0V	-	-	0.20	V	②	
EN1,2 "High" Current	IENH	EN1,2=3.0V	-	-	0.50	μA	②	
EN1,2 "Low" Current	IENL	EN1,2=0V, FB1,2=3.0V	-	-	-0.50	μA	②	
PWM1,2 "High" Current	IPWMH	FB1, 2=3.0V, PWM=3.0V	-	-	0.50	μA	②	
PWM1,2 "Low" Current	IPWML	FB1, 2=3.0V, PWM=0V	-	-	-0.50	μA	②	
FB1,2 "High" Current	IFBH	FB1, 2=3.0V	-	-	0.50	μA	②	
FB1,2 "Low" Current	VFBL	FB1, 2=1.0V	-	-	-0.50	μA	②	

Unless otherwise stated, VDD=3.0V, PWM1,2=3.0V, EN1, 2 =3.0V

#### Output 1 Characteristics

#### Step-down Controller

PARAMETER	SYMBOL	CONDITIONS	MIN.	TYP.	MAX.	UNITS	TEST CIRCUIT
FB1 Voltage	VFB1	VIN=3.0V, IOU1=10mA	0.882	0.900	0.918	V	③
Minimum Operation Voltage	VINmin1		-	-	2.0	V	①
Maximum Duty Ratio 1	MAXDTY1	Same as IDD1	100	-	-	%	②
Minimum Duty Ratio1	MINDTY1	Same as IDD2	-	-	0	%	②
PFM Duty Ratio 1	PFMDTY1	No Load, VPWM1=0V	22	30	38	%	④
Efficiency1 (note 2)	EFF1	IOU1=250mA P-ch MOSFET : XP162A12A6P	-	91	-	%	④
Soft-Start Time1	TSS1	VOU1 × 0.95V, EN1=0V → 0.65V	5.0	10.0	20.0	mS	④
EXT1 "High" ON Resistance	REXTBH1	EN1=0, EXT1=VDD-0.4V	-	28	47	Ω	⑤
EXT1 "Low" ON Resistance	REXTBL1	FB2=0V, EXT1=0.4V	-	22	30	Ω	⑤
PWM1 "High" Voltage	VPWMH1	No Load	0.65	-	-	V	④
PWM1 "Low" Voltage	VPWML1	No Load	-	-	0.20	V	④

Unless otherwise stated, VDD=EN1=PWM1=3.0V, PWM2=EN2=GND, EXT2=OPEN, FB2=OPEN, VIN=5.0V

#### Output 2 Characteristics

#### Step-down Controller

PARAMETER	SYMBOL	CONDITIONS	MIN.	TYP.	MAX.	UNITS	TEST CIRCUIT
FB2 Voltage	VFB2	VIN=3.0V, IOU2=10mA	0.882	0.900	0.918	V	⑥
Minimum Operation Voltage	VINmin2		-	-	2.0	V	①
Maximum Duty Ratio 2	MAXDTY2	Same as IDD1	100	-	-	%	②
Minimum Duty Ratio 2	MINDTY2	Same as IDD2	-	-	0	%	②
PFM Duty Ratio 2	PFMDTY2	No Load, VPWM2=0V	22	30	38	%	⑦
Efficiency2 (note 2)	EFFI2	IOU2=250mA P-ch MOSFET : XP162A12A6P	-	91	-	%	⑦
Soft-Start Time 2	TSS2	VOU2 × 0.95V, EN2=0V → 0.65V	5.0	10.0	20.0	mS	⑦
EXT2 "High" ON Resistance	REXTBH2	EN2=0, EXT2=VDD-0.4V	-	28	47	Ω	⑤
EXT2 "Low" ON Resistance	REXTBL2	FB2=0V, EXT2=0.4V	-	22	30	Ω	⑤
PWM2 "High" Voltage	VPWMH2	No Load	0.65	-	-	V	⑦
PWM2 "Low" Voltage	VPWML2	No Load	-	-	0.20	V	⑦

Unless otherwise stated, VDD=EN2=PWM2=3.0V, PWM1=EN1=GND, EXT1=OPEN, FB1=OPEN, VIN=5.0V

Notes 1) Please be careful not to exceed the breakdown voltage level of the peripheral parts.

2)  $EFFI = \{ [(Output\ voltage) \times (Output\ current)] / [(Input\ voltage) \times (Input\ Current)] \} \times 100$

## ■ Operational Description

The XC9503 series are multi-functional, 2 channel step-down DC/DC converter controller ICs with built-in high speed, low ON resistance drivers.

### <Error Amp 1, 2>

The Error Amplifier is designed to monitor the output voltage and it compares the feedback voltage (FB) with the reference voltage. In response to feedback of a voltage lower than the reference voltage, the output voltage of the error amp. decreases.

### <OSC Generator>

This circuit generates the Switching Frequency which in turn generates the reference clock.

### <Ramp Wave Generator 1, 2>

The Ramp Wave Generator generates a saw-tooth waveform based on outputs from the Phase Shift Generator.

### <PWM Comparator 1, 2>

The PWM Comparator compares outputs from the Error Amp. and saw-tooth waveform. When the voltage from the Error Amp's output is low, the external switch will be set to ON.

### <PWM/PFM Controller 1, 2>

This circuit generates PFM pulses.

Control can be switched between PWM control and PWM/PFM automatic switching control using external signals.

The PWM/PFM automatic switching mode is selected when the voltage of the PWM1 (2) pin is less than 0.2V, and the control switches between PWM and PFM automatically depending on the load. As the PFM circuit generates pulses based on outputs from the PWM comparator, shifting between modes occurs smoothly. PWM control mode is selected when the voltage of the PWM1 (2) pin is more than 0.65V. Noise is easily reduced with PWM control since the switching frequency is fixed.

Control suited to the application can easily be selected which is useful in audio applications, for example, where traditionally, efficiencies have been sacrificed during stand-by as a result of using PWM control (due to the noise problems associated with the PFM mode in stand-by).

### <Vref with Soft Start 1, 2>

The reference voltage, Vref (FB pin voltage)=0.9V, is adjusted and fixed by laser trimming (for output voltage settings, please refer to page 8). To protect against inrush current, when the power is switched on, and also to protect against voltage overshoot, soft-start time is set internally to 10ms. It should be noted, however, that this circuit does not protect the load capacitor (CL) from inrush current. With the Vref voltage limited and depending upon the input to the error amps, the operation maintains a balance between the two inputs of the error amps and controls the EXT pin's ON time so that it doesn't increase more than is necessary.

### <Chip Enable Function>

This function controls the operation and shutdown of the IC. When the voltage of the EN1 or EN2 pins is 0.2V or less, the mode will be chip disable, the channel's operations will stop and the EXT pins will be kept at a highlevel (the external P-type MOSFET will be OFF). When both EN1 and EN2 are in a state of chip disable, current consumption will be no more than 3.0  $\mu$ A.

When the EN1 or EN2 pin's voltage is 0.65V or more, the mode will be chip enable and operations will recommence. With soft-start, 95% of the set output voltage will be reached within 10mS (TYP) from the moment of chip enable.

### <Setting of Output Voltage>

Output voltage can be set by adding external split resistors. Output voltage is determined by the following equation, based on the values of RFB11(RFB21) and RFB12(RFB22). The sum of RFB11(RFB21) and RFB12(RFB22) should normally be 1 MΩ or

$$V_{OUT} = 0.9 \times (R_{FB11} + R_{FB12}) / R_{FB12}$$

The value of CFB1(CFB2), speed-up capacitor for phase compensation, should be  $f_{zfb} = 1 / (2 \times \pi \times C_{FB1} \times R_{FB11})$  which is equal to 12kHz. Adjustments are required from 1kHz to 50kHz depending on the application, value of inductance (L), and value of load capacity (CL).

### [Example of Calculation]

When RFB11=200kΩ and RFB12=75kΩ,  $V_{OUT1} = 0.9 \times (200k + 75k) / 75k = 3.3V$ .

### [Typical Example]

VOUT (V)	RFB11 (kΩ)	RFB12 (kΩ)	CFB1 (pF)	VOUT (V)	RFB11 (kΩ)	RFB12 (kΩ)	CFB1 (pF)
1.0	30	270	430	2.5	390	220	33
1.5	220	330	62	2.7	360	180	33
1.8	220	220	62	3.0	560	240	24
2.0	330	270	39	3.3	200	75	62
2.2	390	270	33	5.0	82	18	160

The same method can be adopted for channel two also.

### [External Components]

Tr : \* MOSFET

XP162A12A6P (TOREX P-Channel Power MOSFET)

Note : VGS Breakdown Voltage of this Tr. is 12V  
so please be careful with the power supply voltage.

SD : MA2Q737 (Schottky, MATSUSHITA)  
CMS02 (Schottky, TOSHIBA)

L : 10μH (SUMIDA, CDRH5D28, FOSC = 500kHz)  
22μH (SUMIDA, CDRH5D28, FOSC = 300kHz)  
22μH (SUMIDA, CDRH5D28, FOSC = 180kHz)

CL : 16V, 47μF (Tantalum)  
Increase capacity according to the equation below  
when the step-up voltage ratio is large and output  
current is high.

$$C = (CL \text{ standard value}) \times (I_{OUT} \text{ (mA)} / 500\text{mA}) \times V_{OUT} / V_{IN}$$

Tr : \* PNP MOSFET  
2SA1213 (SANYO)

RB : 500Ω (Adjust in accordance with load & Tr.'s HFE.)  
Set according to the equation below.  
 $RB \leq (V_{IN} - 0.7) \times h_{FE} / I_C - R_{EXTBH}$

CB : 2200pF (Ceramic)  
Set according to the equation below.  
 $CB \leq (2 \pi \times RB \times FOSC \times 0.7)$

The same components can be adopted for both channel 1 and channel 2.



### ■ Test Circuits

Circuit 1

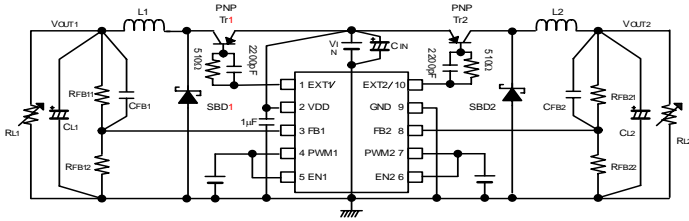

Circuit 5

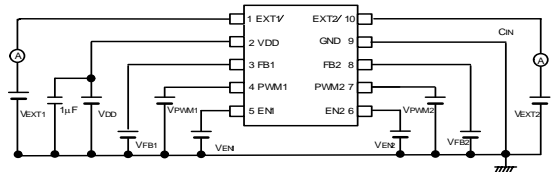

Circuit 2

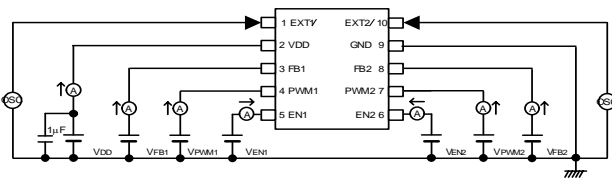

Circuit 6

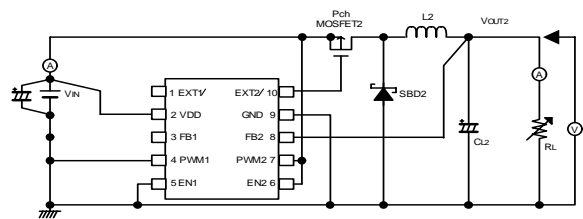

Circuit 3

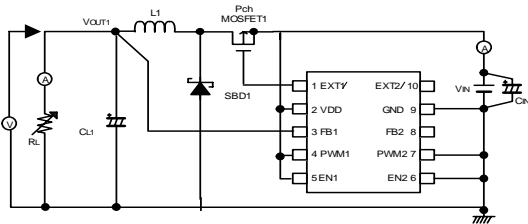

Circuit 7

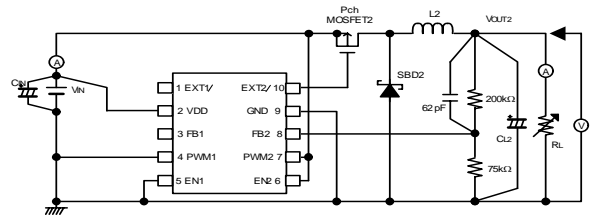

Circuit 4

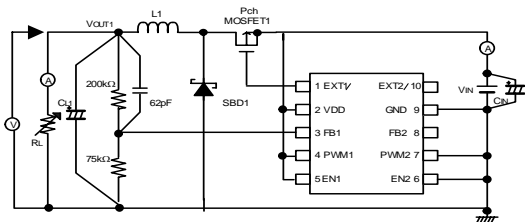

## ■ Peripheral Components Used for Test Circuits

### Circuit 1

L1, L2 :	22 $\mu$ H (SUMIDA CDRH5D28) : XC9503B092A
	15 $\mu$ H (SUMIDA CDRH5D28) : XC9503B093A
	10 $\mu$ H (SUMIDA CDRH5D28) : XC9503B095A
SD1, SD2 :	CRS02 (Schottky diode, TOSHIBA)
	EC10QS06 (Schottky diode, NIHON INTER)
CL1, CL2 :	16MCE476MD2 (Tantalum, NIHON CHEMICON)
CIN :	16MCE476MD2 (Tantalum, NIHON CHEMICON)
PNP Tr1, 2:	2SA1213 (TOSHIBA)
RFB :	Please use by the conditions as below.
	$RFB11 + RFB12 \leq 1M\Omega$
	$RFB21 + RFB22 \leq 1M\Omega$
	$RFB11 / RFB12 = (\text{Setting Output Voltage} / 0.9) - 1$
	$VOUT2 = (0.9 - VOUT1) \times (RFB21 / RFB22) + 0.9V$
CFB :	Please adjust as below:
	$fzfb = 1 / (2 \times \pi \times CFB1 \times RFB11) = 1\text{kHz} \sim 50\text{kHz}$ ( 12kHz usual)
	$fzfb = 1 / (2 \times \pi \times CFB2 \times RFB21) = 1\text{kHz} \sim 50\text{kHz}$ ( 12kHz usual)

### Circuits 3

L1 :	22 $\mu$ H (SUMIDA CDRH5D28)
SD1 :	MA2Q737 (Schottky diode, MATSUSHITA)
CL1 :	16MCE476MD2 (Tantalum, NIHON CHEMICON)
CIN :	16MCE476MD2 (Tantalum, NIHON CHEMICON)
P-ch MOSFET1 :	XP161A12A6P (TOREX)

### Circuits 4

L1 :	22 $\mu$ H (SUMIDA CDRH5D28) : XC9503B092A
	15 $\mu$ H (SUMIDA CDRH5D28) : XC9503B093A
	10 $\mu$ H (SUMIDA CDRH5D28) : XC9503B095A
SD1 :	MA2Q737 (Schottky, MATSUSHITA)
CL1 :	16MCE476MD2 (Tantalum, NIHON CHEMICON)
CIN :	16MCE476MD2 (Tantalum, NIHON CHEMICON)
P-ch MOSFET1 :	XP161A12A6P (TOREX)

### Circuit 6

L1 :	22 $\mu$ H (SUMIDA CDRH5D28)
SD1 :	MA2Q737 (Schottky diode, MATSUSHITA)
CL1 :	16MCE476MD2 (Tantalum, NIHON CHEMICON)
CIN :	16MCE476MD2 (Tantalum, NIHON CHEMICON)
P-ch MOSFET2 :	XP162A12A6P (TOREX)

### Circuit 7

L2 :	22 $\mu$ H (SUMIDA CDRH5D28) : XC9503B092A
	15 $\mu$ H (SUMIDA CDRH5D28) : XC9503B093A
	10 $\mu$ H (SUMIDA CDRH5D28) : XC9503B095A
SD2 :	MA2Q737 (Schottky, MATSUSHITA)
CL2 :	16MCE476MD2 (Tantalum, NIHON CHEMICON)
CIN :	16MCE476MD2 (Tantalum, NIHON CHEMICON)
P-ch MOSFET2 :	XP161A12A6P (TOREX)

## ■ Notes on Use

### 1. Checking for Intermittent Oscillation

The XC9503 series is subject to intermittent oscillation in the proximity of the maximum duty if the step-down ratio is low (e.g., from 4.2 V to 3.3 V) or a heavy load is applied where the duty ratio becomes high. Check waveforms at EXT under your operating conditions. A remedy for this problem is to raise the inductance of coil L or increase the load capacitance CL.

### 2. PWM/PFM Automatic Switching

If PWM/PFM automatic switching control is selected and the step-down ratio is high (e.g., from 10 V to 1.0 V), the control mode remains in PFM setting over the whole load range, since the duty ratio under continuous-duty condition is smaller than the PFM duty ratio of the XC9503 series. The output voltage's ripple voltage becomes substantially high under heavy load conditions, with the XC9503 series appearing to be producing an abnormal oscillation. If this operation becomes a concern, set pins PWM1 and PWM2 to High to set the control mode to PWM setting. For use under the above-mentioned condition, measured data of PWM/PFM automatic switching control shown on the data sheets are available up to IOU<sub>T</sub> = 100 mA.

### 3. Ratings

Use the XC9503 series and peripheral components within the limits of their ratings.

### Typical Performance Characteristics

#### (1) Output Voltage vs. Output Current

**FOSC=300kHz, VOUT1, 2=1.0V**

L=22μH(CDRH5D28), CL=94μF(Tantalum)  
SD:CMS02, Tr:XP162A12A6P

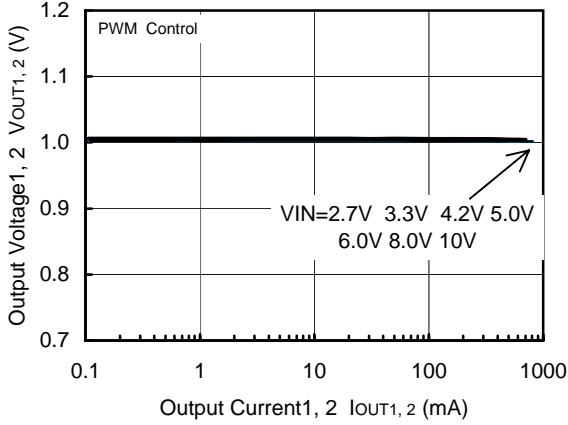

**FOSC=300kHz, VOUT1, 2=1.0V**

L=22μH(CDRH5D28), CL=94μF(Tantalum)  
SD:CMS02, Tr:XP162A12A6P

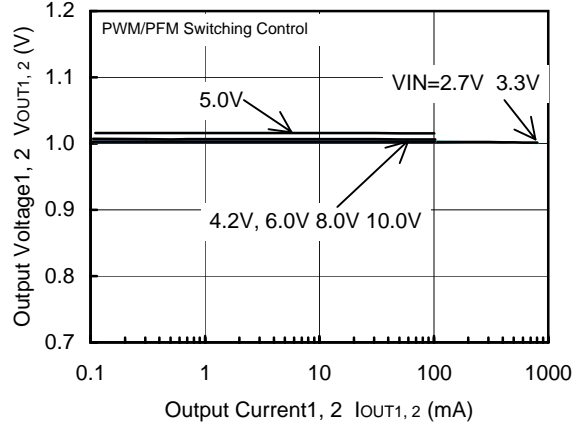

**FOSC=300kHz, VOUT1, 2=1.8V**

L=22μH(CDRH5D28), CL=94μF(Tantalum)  
SD:CMS02, Tr:XP162A12A6P

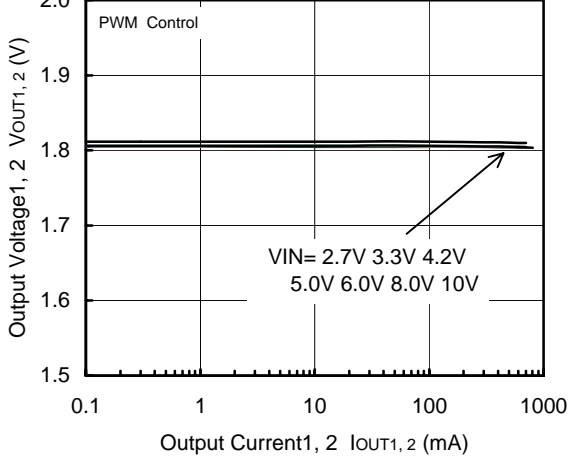

**FOSC=300kHz, VOUT1, 2=1.8V**

L=22μH(CDRH5D28), CL=94μF(Tantalum)  
SD:CMS02, Tr:XP162A12A6P

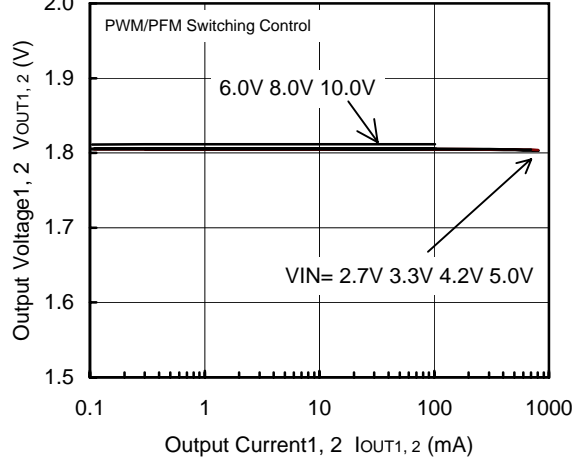

**FOSC=300kHz, VOUT1, 2=2.5V**

L=22μH(CDRH5D28), CL=94μF(Tantalum)  
SD:CMS02, Tr:XP162A12A6P

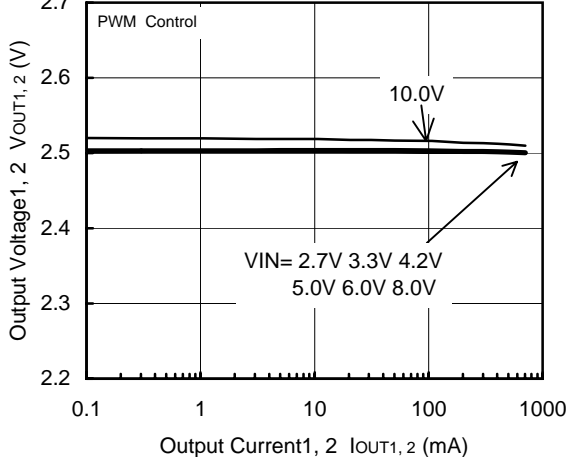

**FOSC=300kHz, VOUT1, 2=2.5V**

L=22μH(CDRH5D28), CL=94μF(Tantalum)  
SD:CMS02, Tr:XP162A12A6P

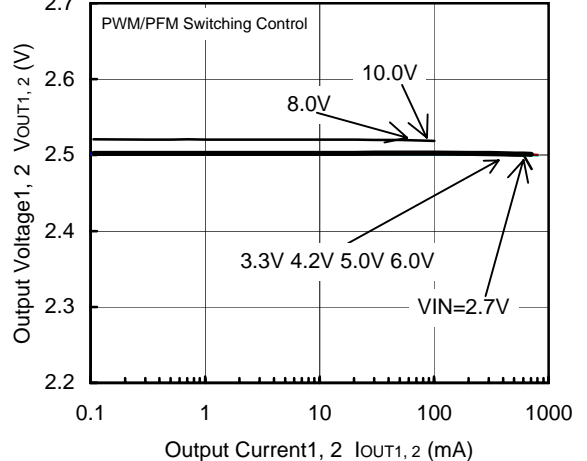

\* When setting VOUT1, 2 = 1.0V, VIN=8.0V, 10.0V,  
CL should be 94μF (Tantalum) + 100μF (OS-COM)

(1) Output Voltage vs. Output Current (continued)

**FOSC=300kHz, V<sub>OUT1,2</sub>=3.3V**

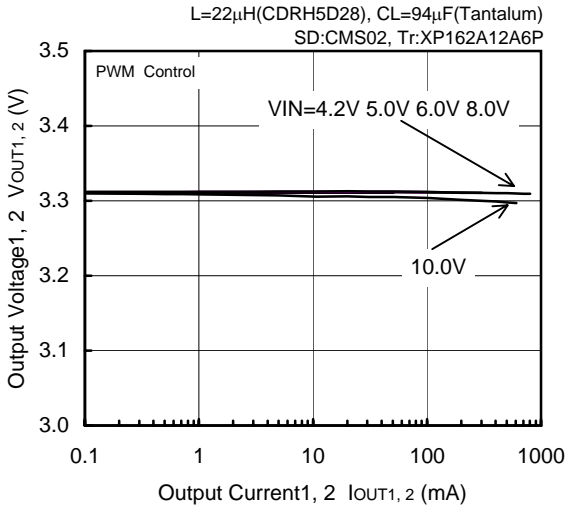

**FOSC=300kHz, V<sub>OUT1,2</sub>=3.3V**

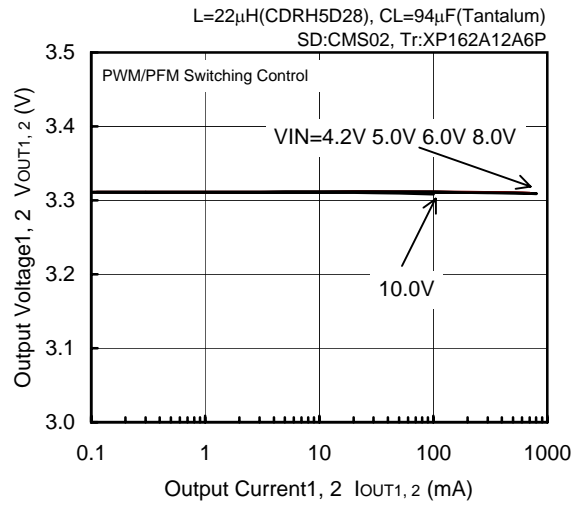

**FOSC=300kHz, V<sub>OUT1,2</sub>=5.0V**

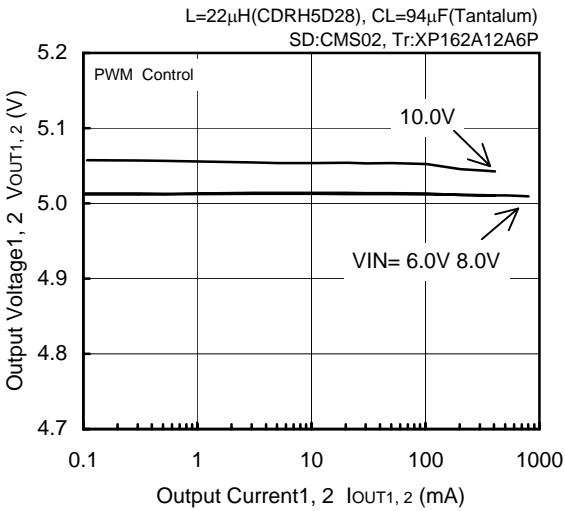

**FOSC=300kHz, V<sub>OUT1,2</sub>=5.0V**

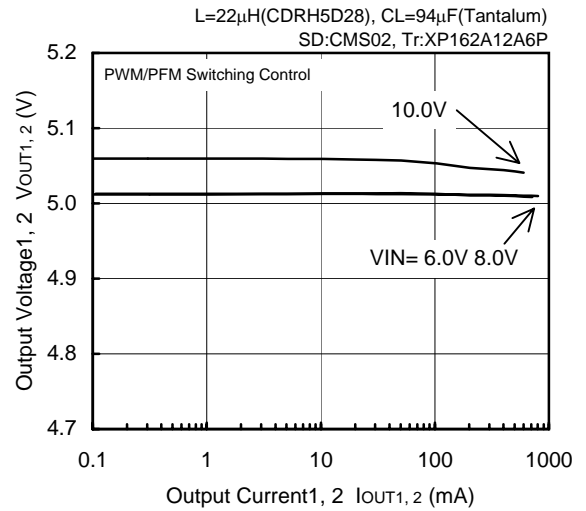

**FOSC=180kHz, V<sub>OUT1,2</sub>=1.0V**

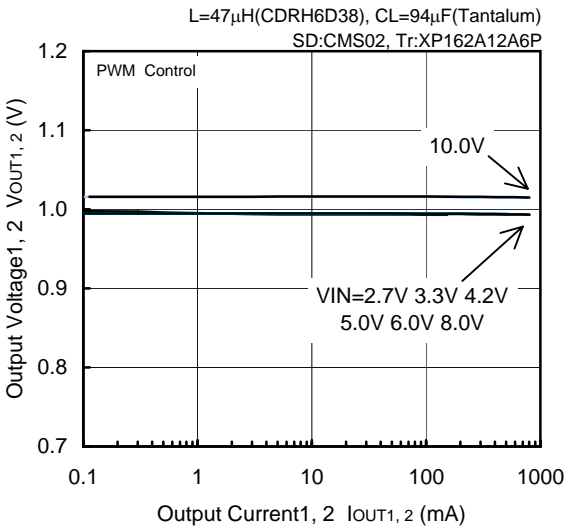

**FOSC=180kHz, V<sub>OUT1,2</sub>=1.0V**

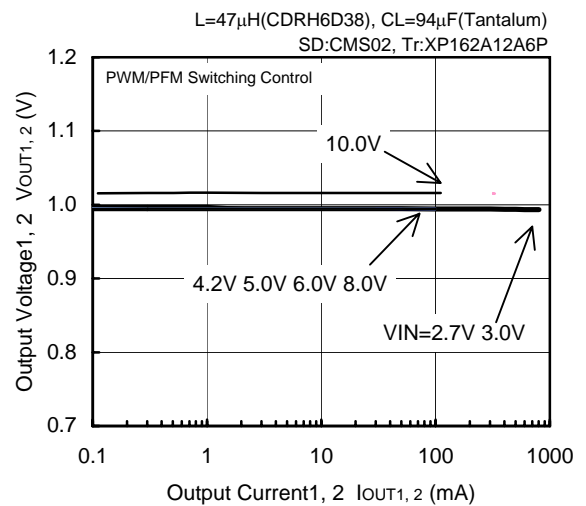

\* When setting V<sub>OUT1,2</sub> = 1.0V, VIN = 8.0V, 10.0V, CL should be 94μF (Tantalum) + 100μF (OS-COM)

(1) Output Voltage vs. Output Current (continued)

**FOSC=180kHz, VOUT1, 2=3.3V**

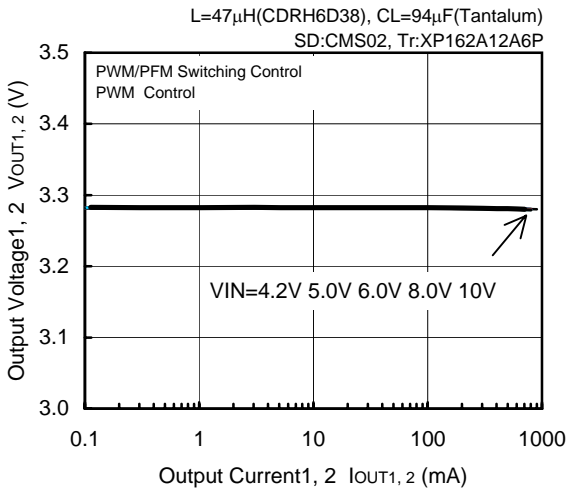

**FOSC=180kHz, VOUT1, 2=5.0V**

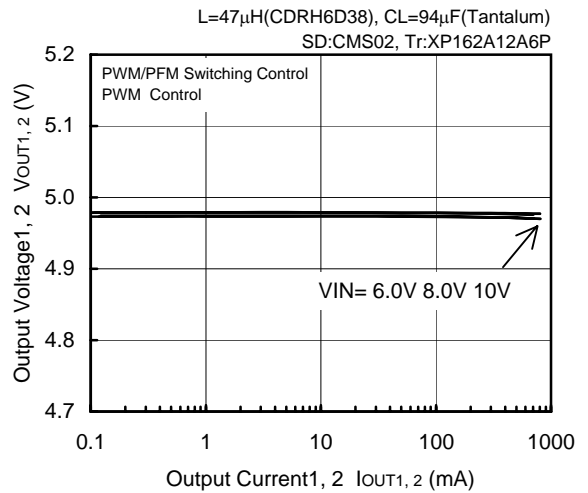

**FOSC=500kHz, VOUT1, 2=1.0V**

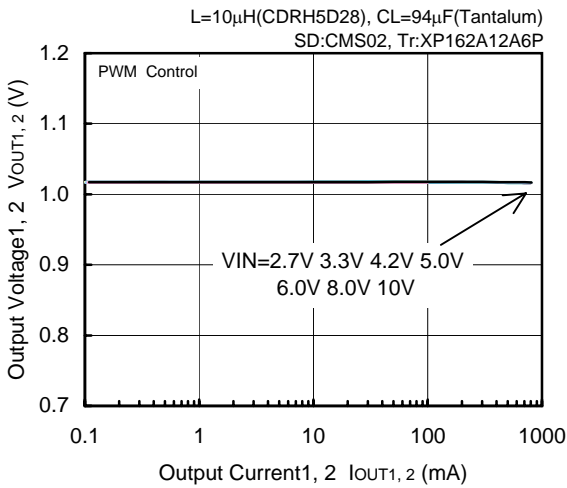

**FOSC=500kHz, VOUT1, 2=1.0V**

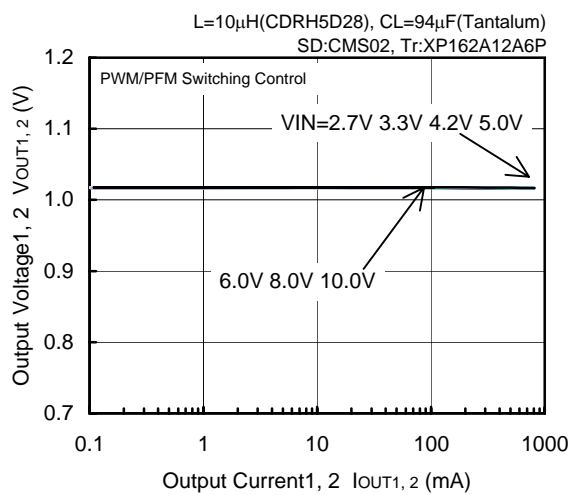

**FOSC=500kHz, VOUT1, 2=3.3V**

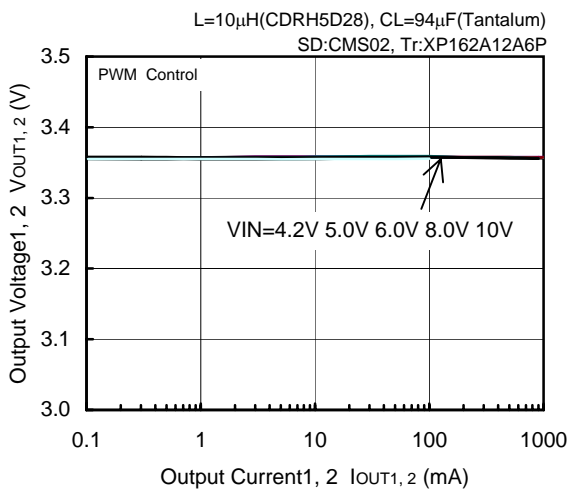

**FOSC=500kHz, VOUT1, 2=3.3V**

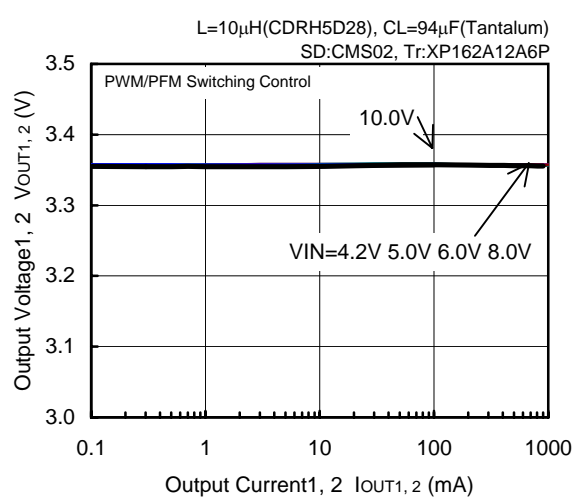

\* When setting VOUT1, 2 =1.0V, VIN=8.0V, 10.0V, CL should be 94 $\mu$ F (Tantalum) + 100 $\mu$ F (OS-COM)

(1) Output Voltage vs. Output Current (continued)

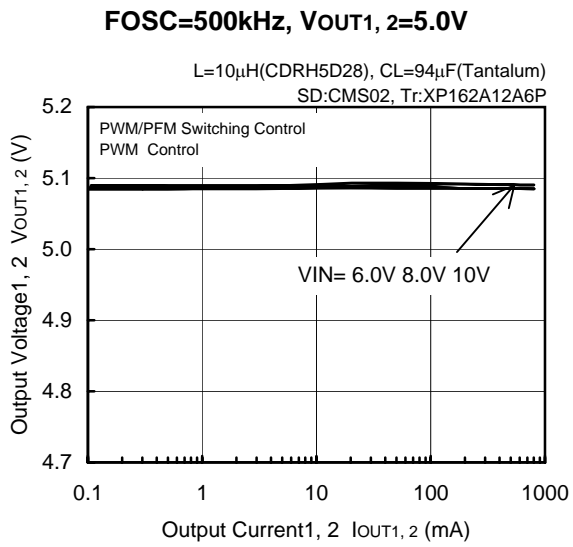

### (2) Efficiency vs. Output Current

**FOSC=300kHz, VOUT1, 2=1.0V**

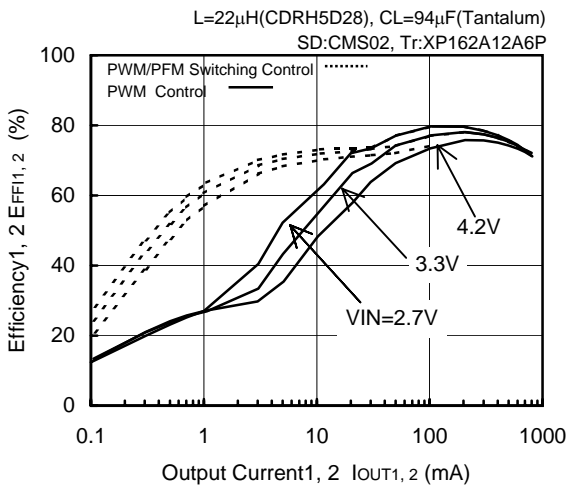

**FOSC=300kHz, VOUT1, 2=1.0V**

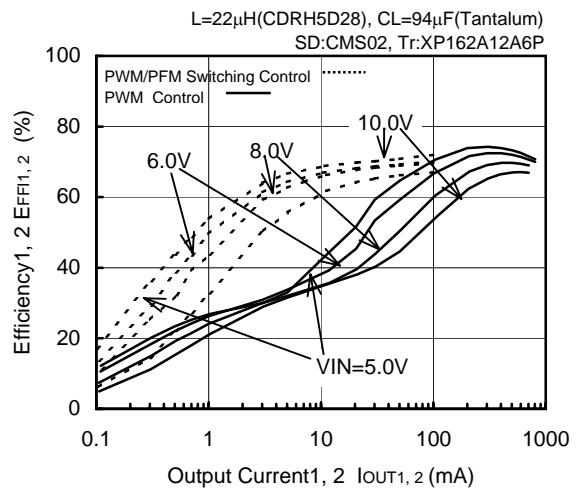

**FOSC=300kHz, VOUT1, 2=1.8V**

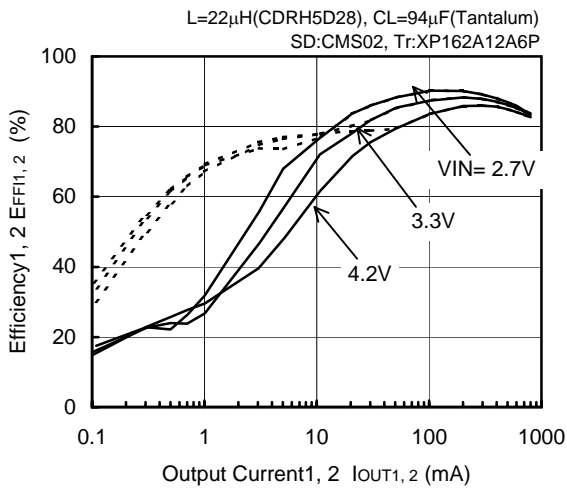

**FOSC=300kHz, VOUT1, 2=1.8V**

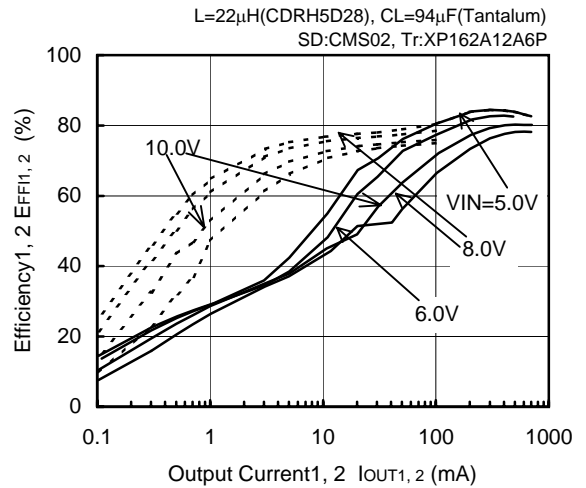

**FOSC=300kHz, VOUT1, 2=2.5V**

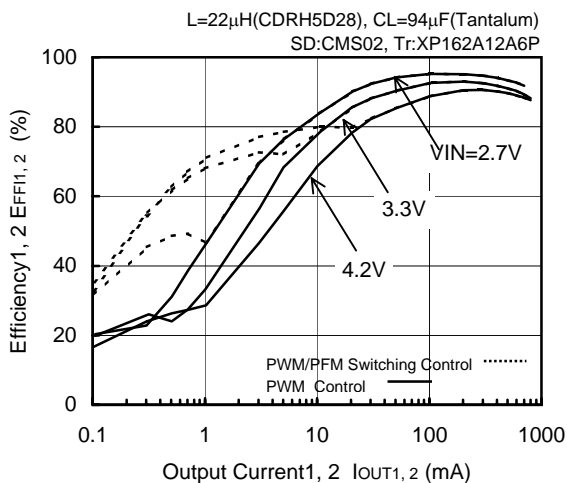

**FOSC=300kHz, VOUT1, 2=2.5V**

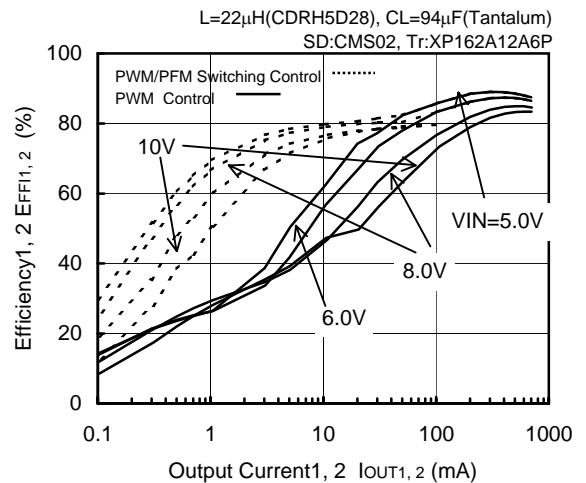

\* When setting VOUT1, 2=1.0V, VIN=8.0V, 10.0V, CL should be 94 $\mu$ F (Tantalum) + 100 $\mu$ F (OS-COM)



(2) Efficiency vs. Output Current (continued)

**FOSC=300kHz, VOUT1, 2=3.3V**

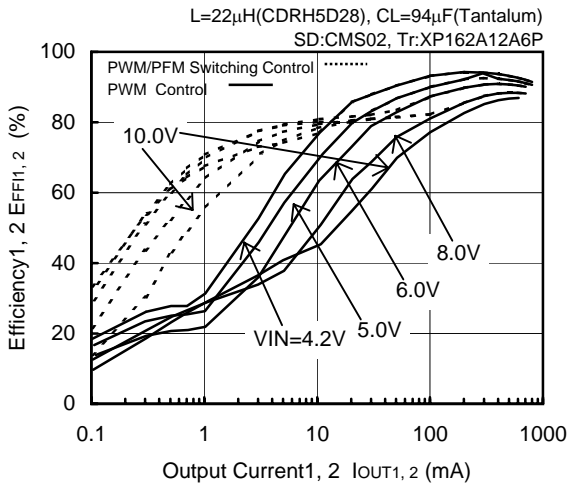

**FOSC=300kHz, VOUT1, 2=5.0V**

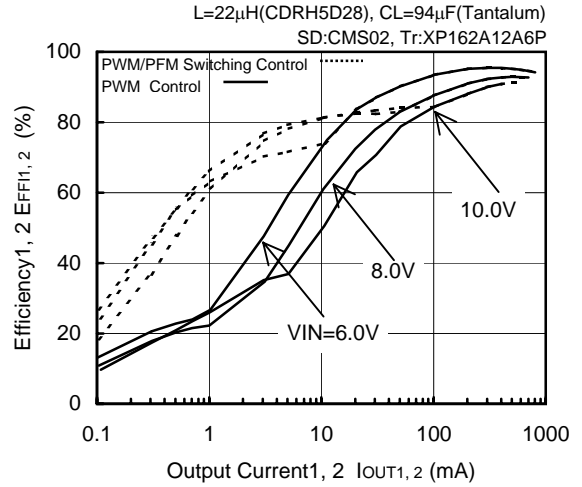

**FOSC=180kHz, VOUT1, 2=1.0V**

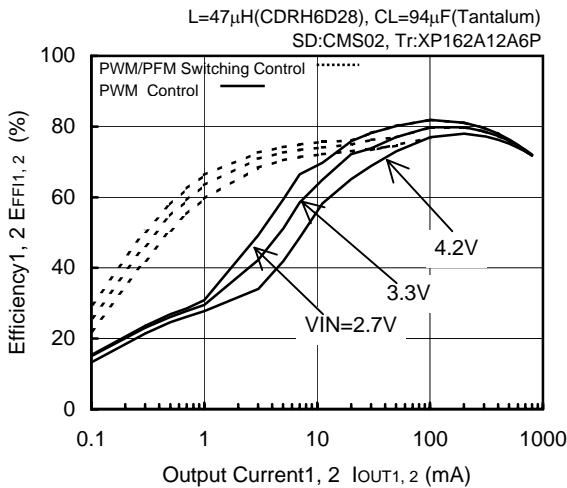

**FOSC=180kHz, VOUT1, 2=1.0V**

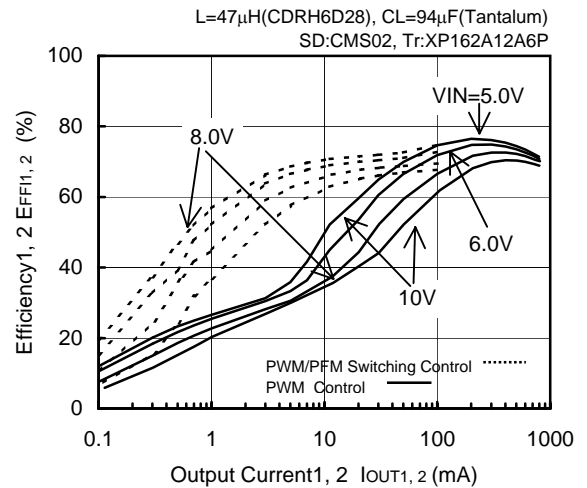

**FOSC=180kHz, VOUT1, 2=3.3V**

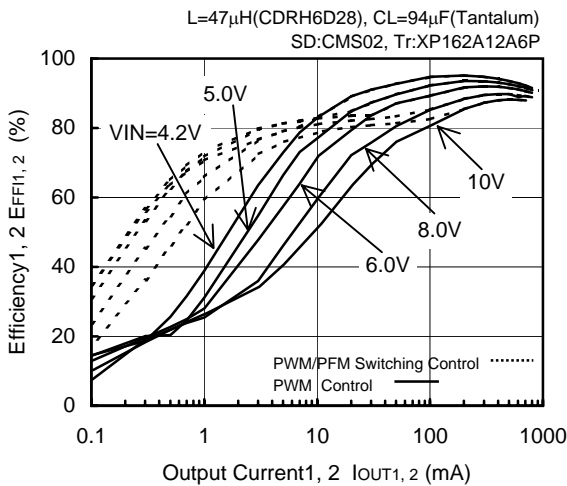

**FOSC=180kHz, VOUT1, 2=5.0V**

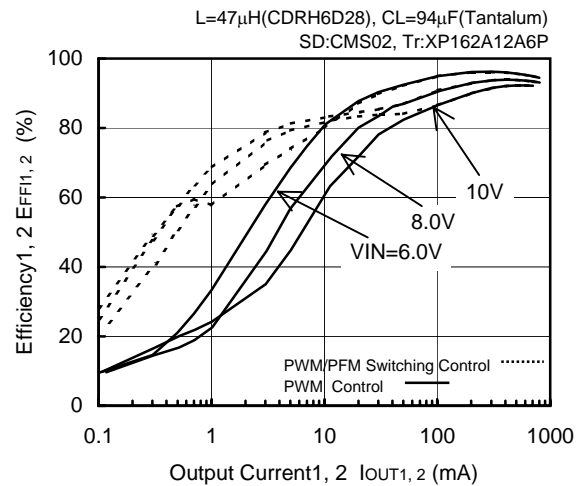

\* When setting VOUT1, 2 = 1.0V, VIN = 8.0V, 10.0V, CL should be 94 $\mu$ F (Tantalum) + 100 $\mu$ F (OS-COM)

(2) Efficiency vs. Output Current (continued)

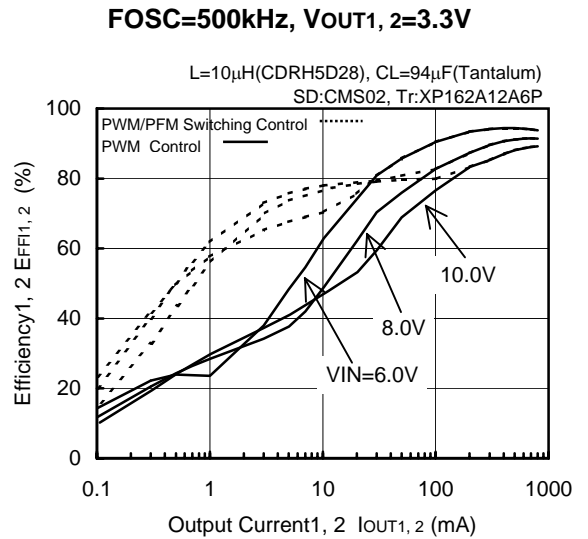
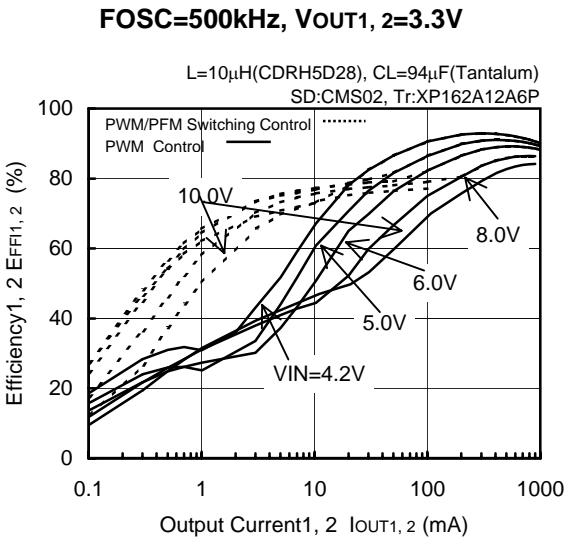
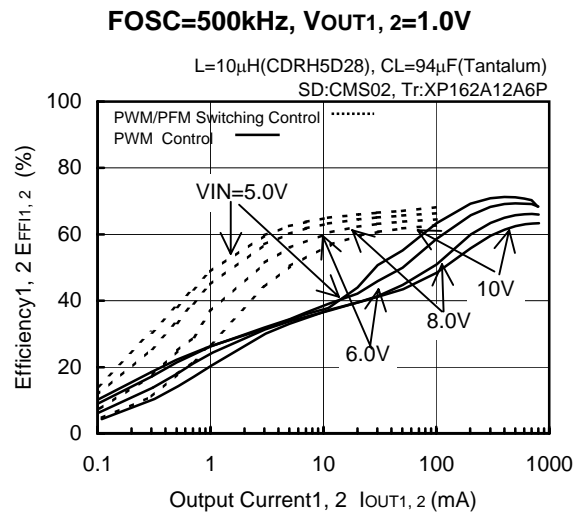
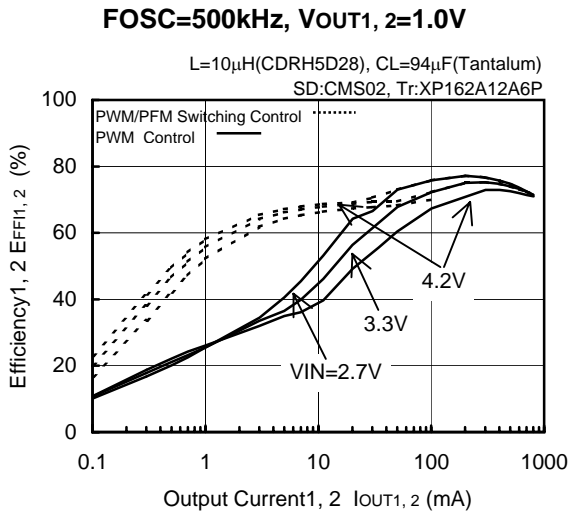

\* When setting V<sub>OUT1, 2</sub> =1.0V, VIN=8.0V, 10.0V,  
CL should be 94 $\mu$ F (Tantalum) + 100 $\mu$ F (OS-COM)

### (3) Ripple Voltage vs. Output Current

**FOSC=300kHz, VOUT1, 2=1.0V**

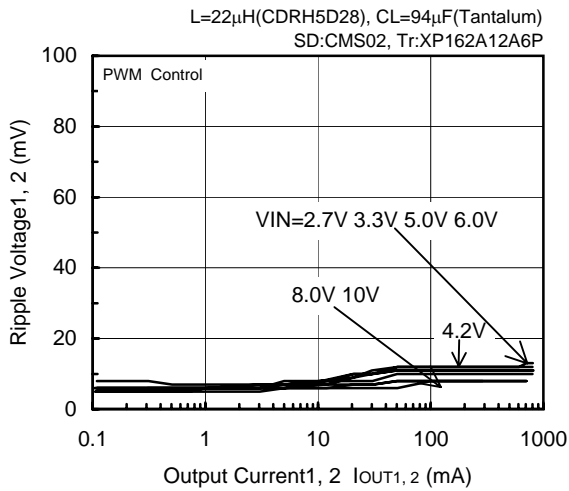

**FOSC=300kHz, VOUT1, 2=1.0V**

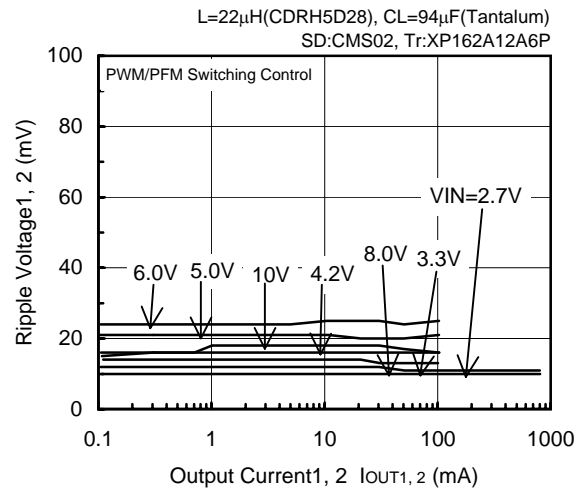

**FOSC=300kHz, VOUT1, 2=1.8V**

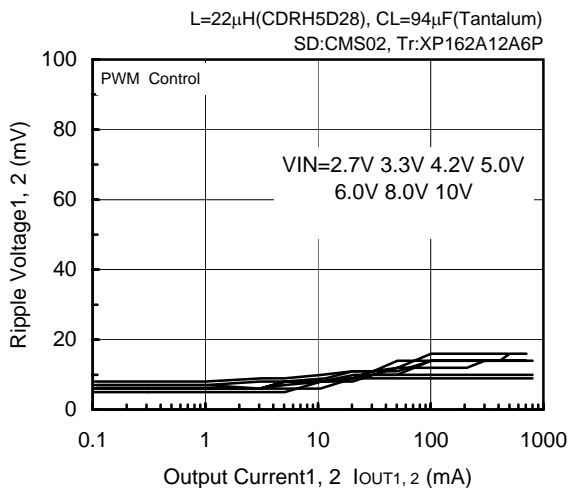

**FOSC=300kHz, VOUT1, 2=1.8V**

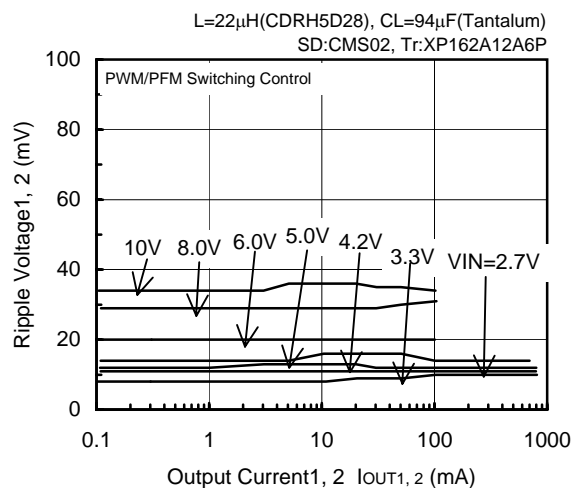

**FOSC=300kHz, VOUT1, 2=2.5V**

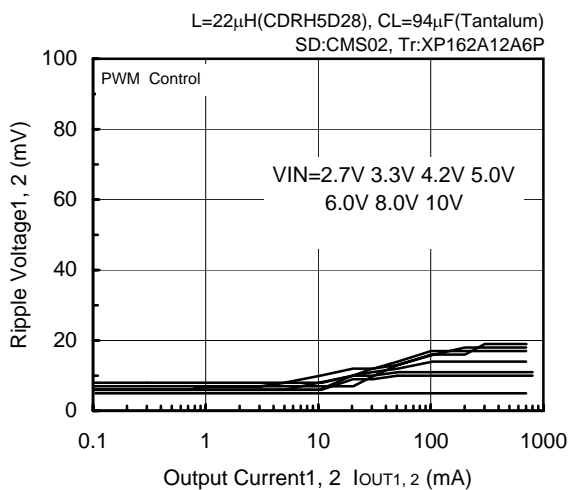

**FOSC=300kHz, VOUT1, 2=2.5V**

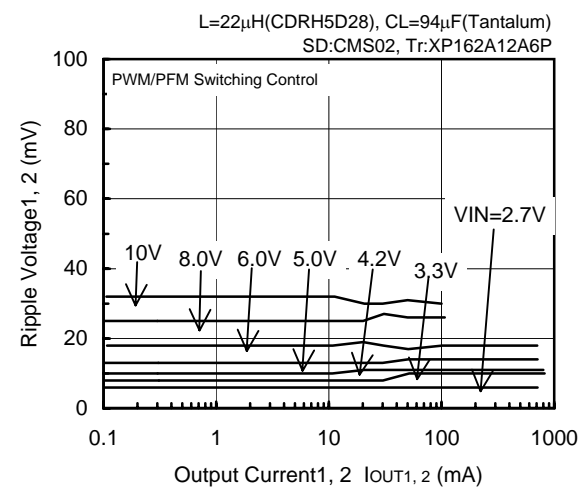

\* When setting VOUT1, 2 = 1.0V, VIN=8.0V, 10.0V, CL should be 94 $\mu$ F (Tantalum) + 100 $\mu$ F (OS-COM)

### (3) Ripple Voltage vs. Output Current (continued)

**FOSC=300kHz, VOUT1, 2=3.3V**

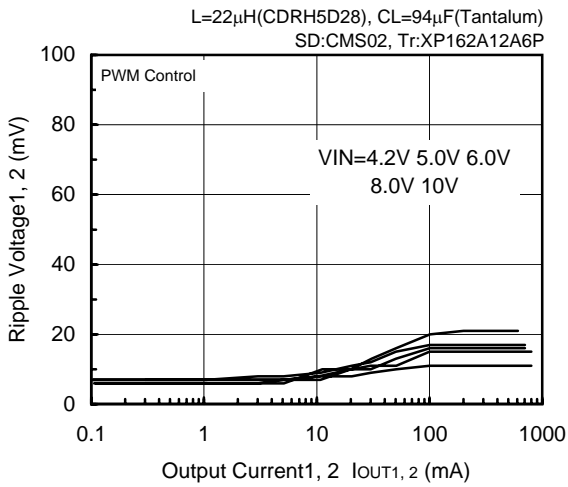

**FOSC=300kHz, VOUT1, 2=3.3V**

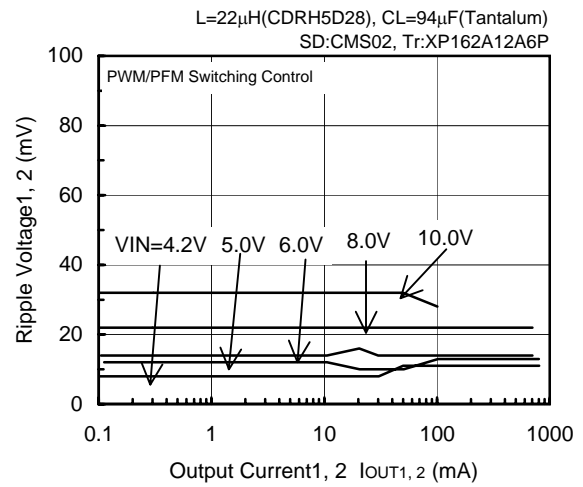

**FOSC=300kHz, VOUT1, 2=5.0V**

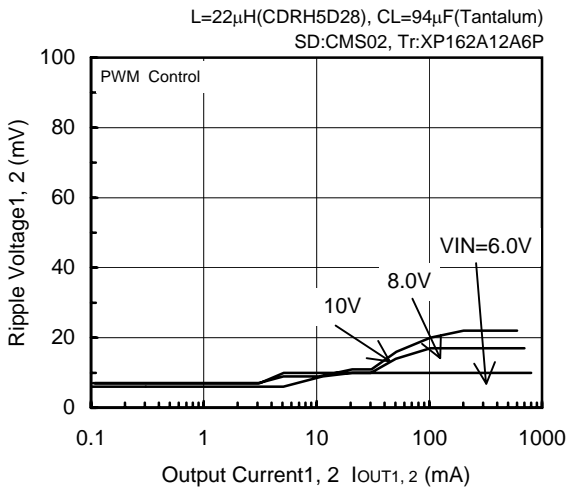

**FOSC=300kHz, VOUT1, 2=5.0V**

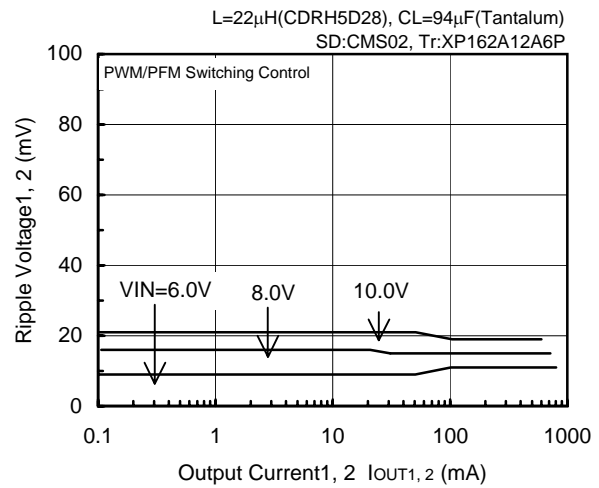

**FOSC=180kHz, VOUT1, 2=1.0V**

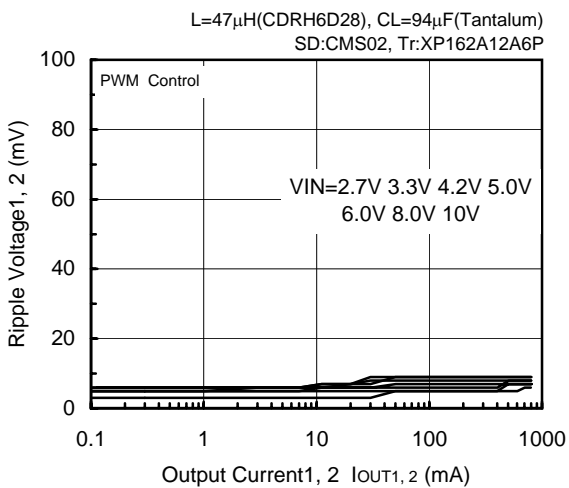

**FOSC=180kHz, VOUT1, 2=1.0V**

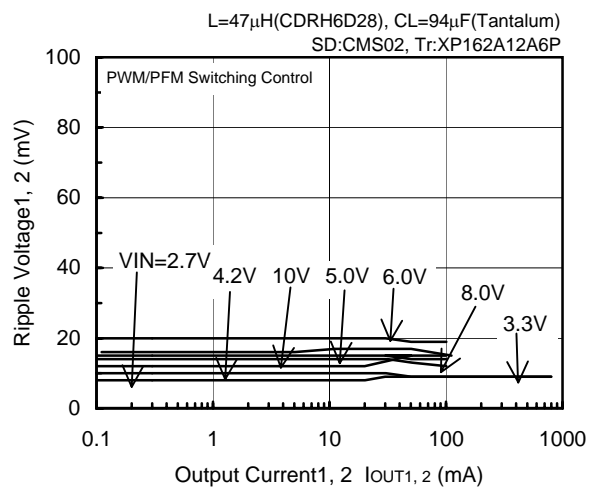

\* When setting VOUT1, 2 = 1.0V, VIN = 8.0V, 10.0V, CL should be 94 $\mu$ F (Tantalum) + 100 $\mu$ F (OS-COM)

### (3) Ripple Voltage vs. Output Current (continued)

**FOSC=180kHz, VOUT1, 2=3.3V**

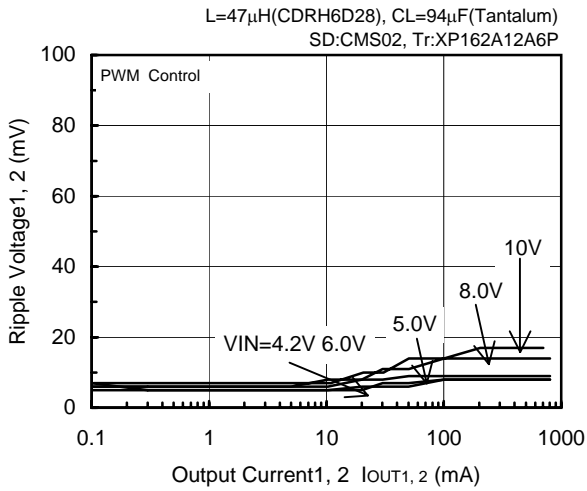

**FOSC=180kHz, VOUT1, 2=3.3V**

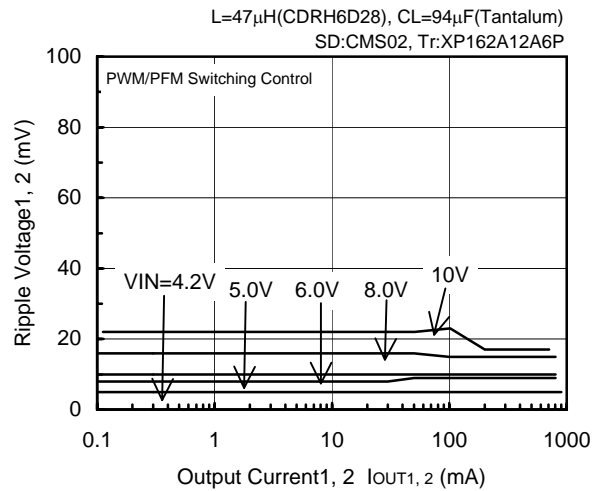

**FOSC=180kHz, VOUT1, 2=5.0V**

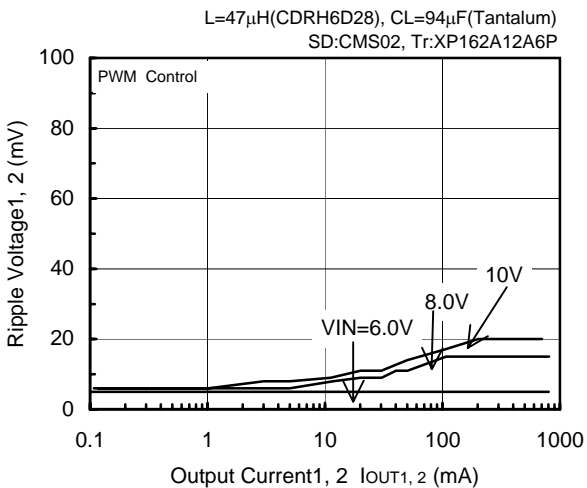

**FOSC=180kHz, VOUT1, 2=5.0V**

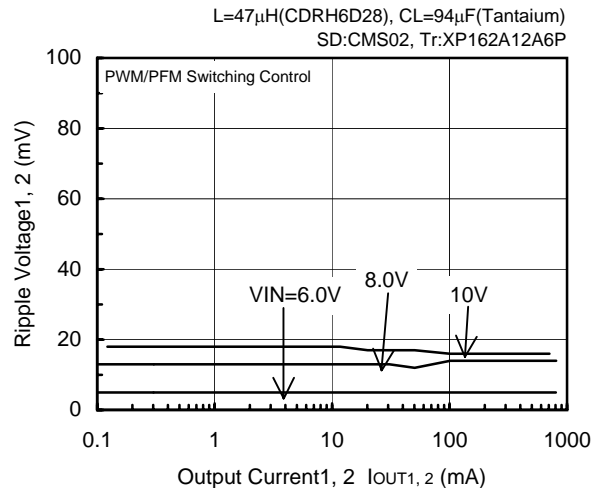

**FOSC=500kHz, VOUT1, 2=1.0V**

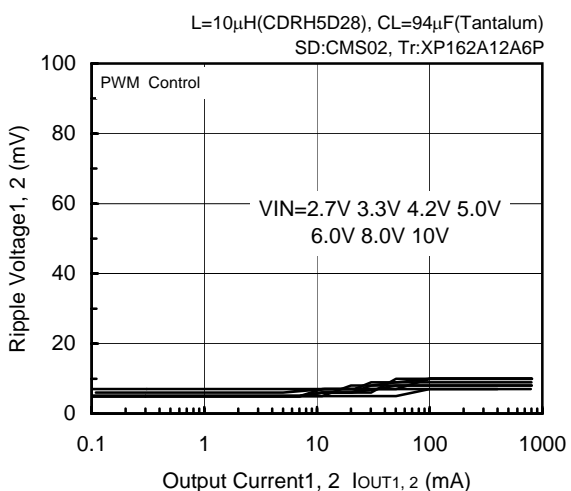

**FOSC=500kHz, VOUT1, 2=1.0V**

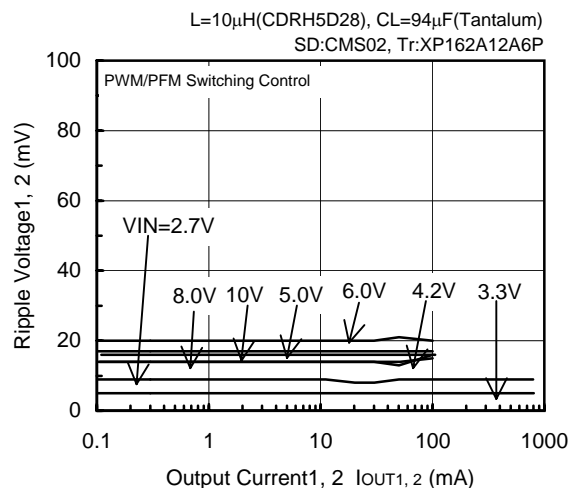

\* When setting VOUT1, 2 =1.0V, VIN=8.0V, 10.0V,  
CL should be 94 $\mu$ F (Tantalum) + 100 $\mu$ F (OS-COM)

(3) Ripple Voltage vs. Output Current (continued)

**FOSC=500kHz, V<sub>OUT1,2</sub>=3.3V**

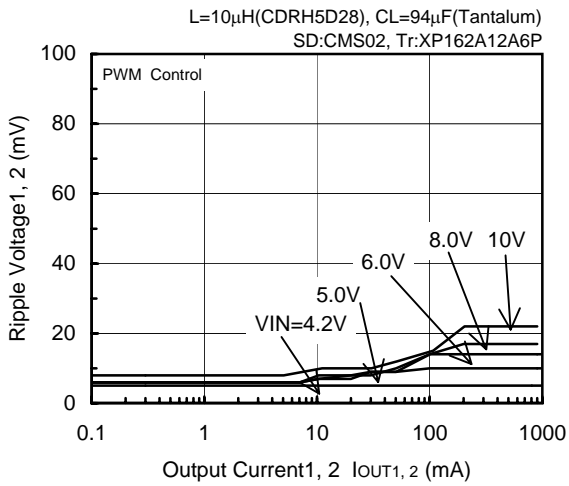

**FOSC=500kHz, V<sub>OUT1,2</sub>=3.3V**

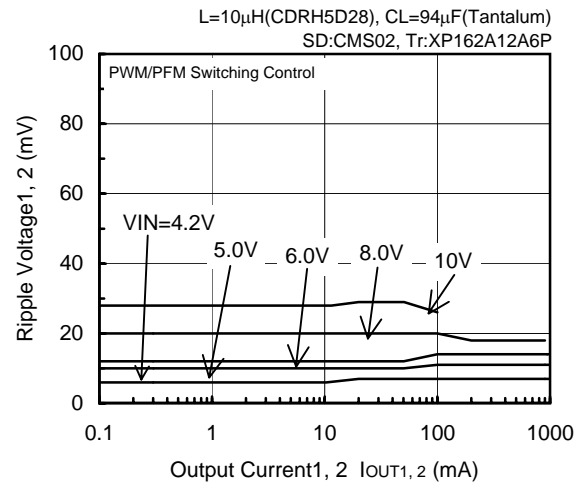

**FOSC=500kHz, V<sub>OUT1,2</sub>=5.0V**

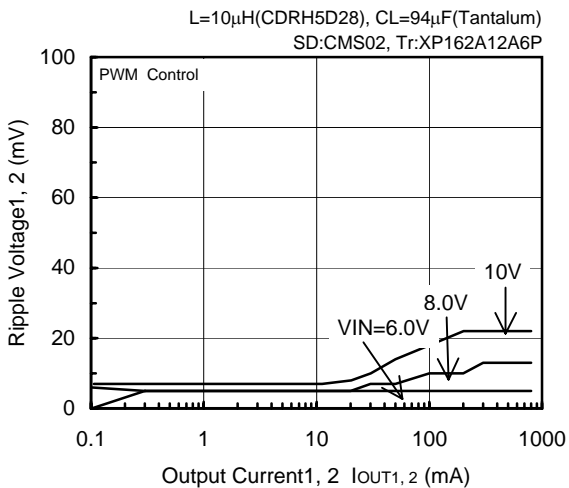

**FOSC=500kHz, V<sub>OUT1,2</sub>=5.0V**

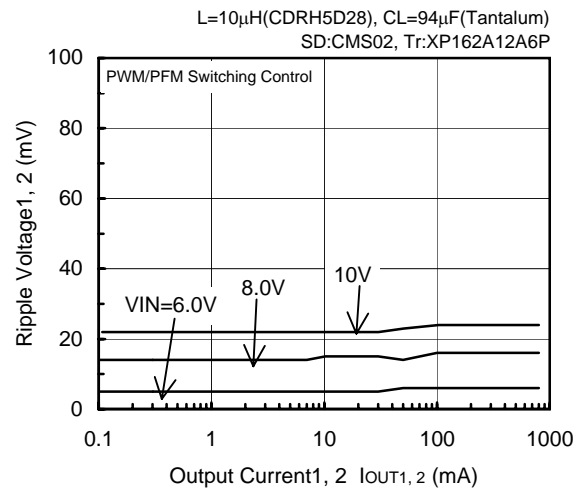

(4) Supply Current 1 vs. Supply Voltage

**XC9503B092 (180KHz)**

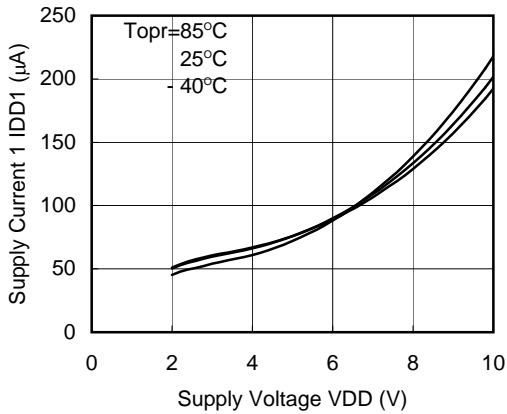

(5) Supply Current 1\_1 vs. Supply Voltage

**XC9503B092 (180KHz)**

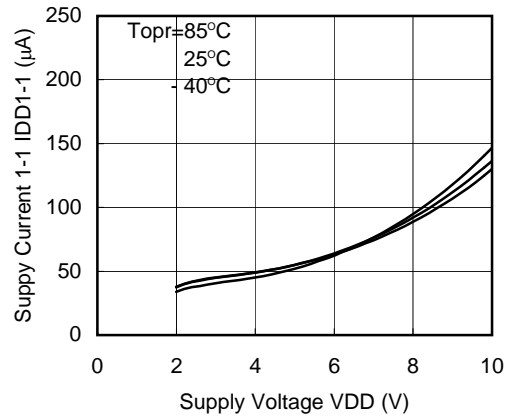

(6) Supply Current 1\_2 vs. Supply Voltage

**XC9503B092 (180KHz)**

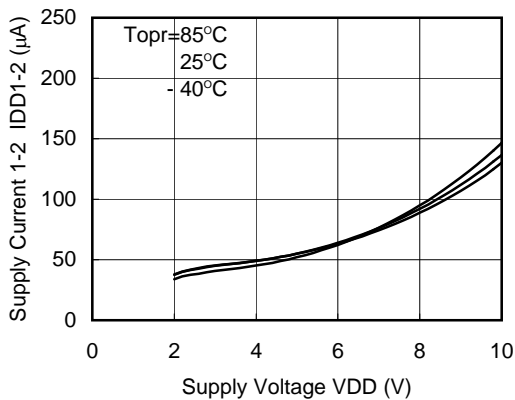

(7) Supply Current 2 vs. Supply Voltage

**XC9503B092 (180KHz)**

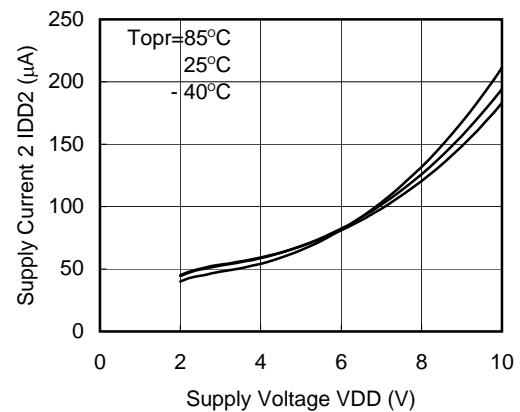

(8) Stand-by Current vs. Supply Voltage

**XC9503B092 (180KHz)**

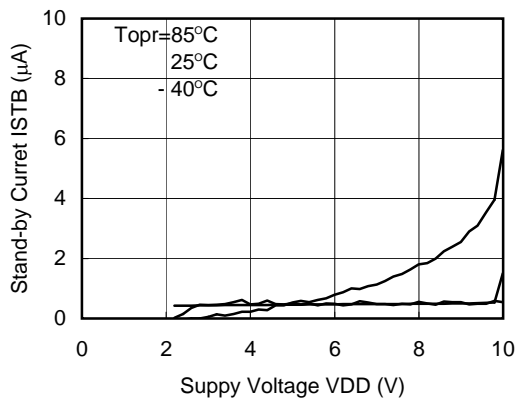

(9) Oscillation Frequency vs. Supply Voltage

**XC9503B093(180kHz)**

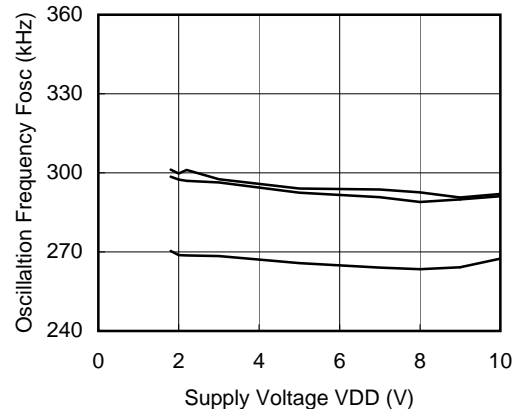

(10) EN1, 2 'High' 'Low' Voltage vs. Supply Voltage

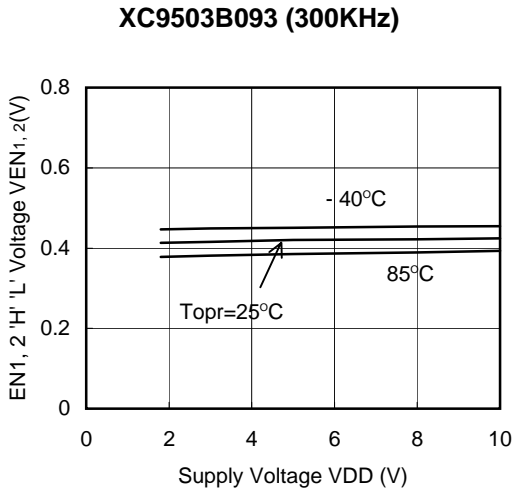

(11) PWM1, 2 'High' 'Low' Voltage vs. Supply Voltage

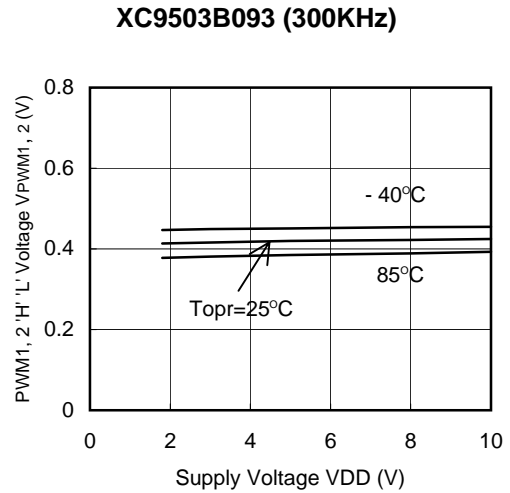

(12) PFM duty ratio 1, 2 vs. Supply Voltage

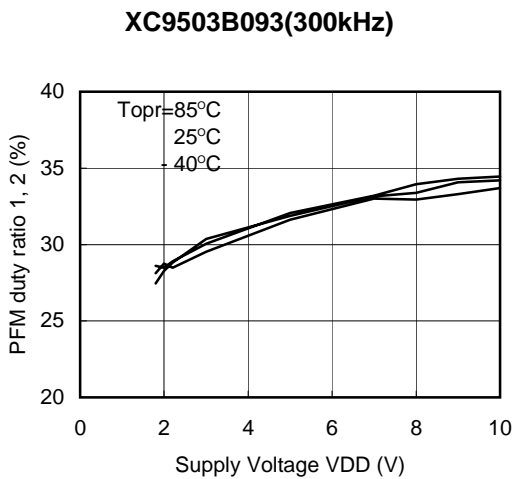

(13) Output Voltage vs. Ambient Temperature

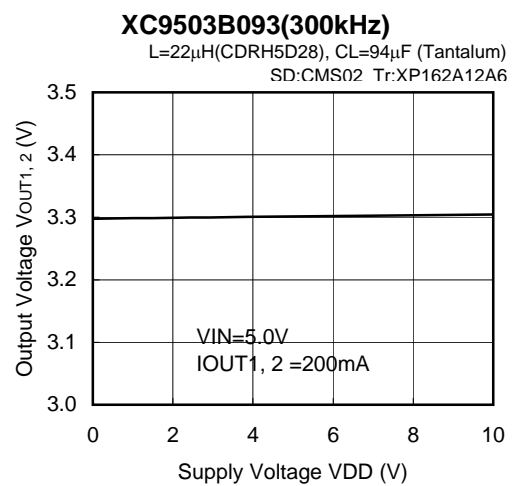

(14) EXT1, 2 'High' On Resistance vs. Supply Voltage

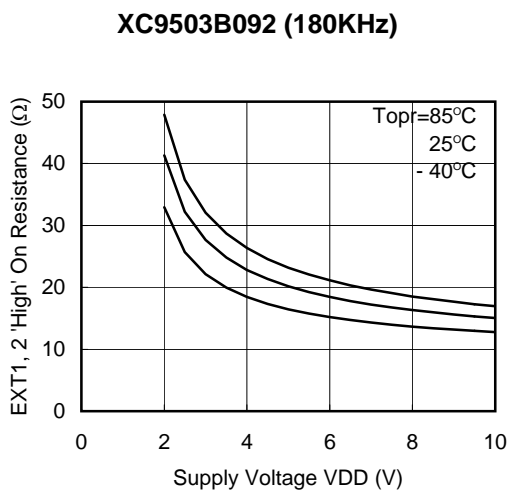

(14) EXT1, 2 'Low' On Resistance vs. Supply Voltage

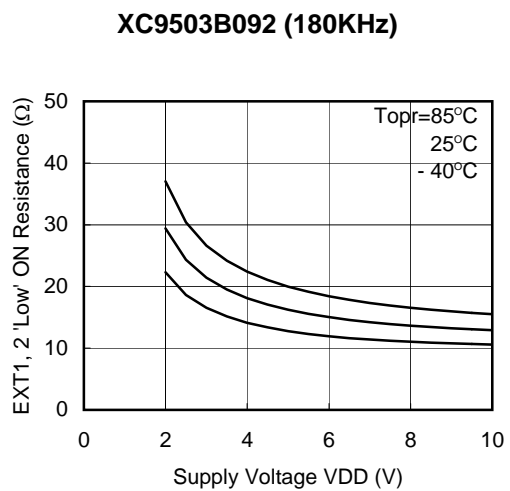



(16) Soft Start Time 1, 2 vs. Supply Voltage

### XC9503B092 (180KHz)

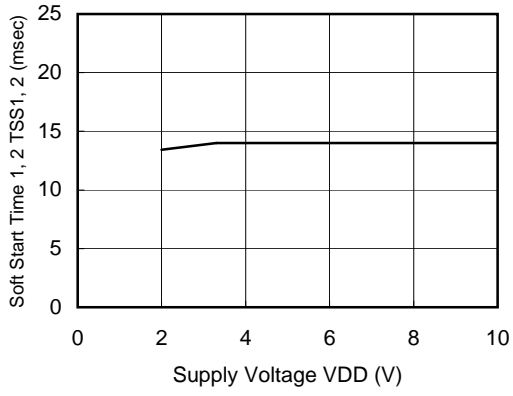

### ■ Load Transient Response

< VOUT1, 2 = 3.3 V, VIN = 5.0V IOUT1, 2 = 100 $\mu$ A  $\leftrightarrow$  300mA >

#### ○ PWM Control

FOSC = 300kHz, VOUT1, 2 = 3.3V  
VIN = 5.0V, IOUT = 1, 2 = 100 $\mu$ A  $\rightarrow$  300mA

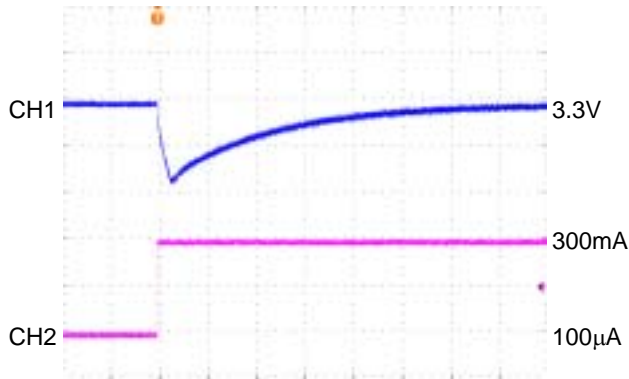

200 $\mu$ sec / div

CH1 : VOUT1, 2, AC-COUPLED, 100mV/div  
CH2 : IOUT1, 2, 150mA/div

FOSC = 300kHz, VOUT1, 2 = 3.3V  
VIN = 5.0V, IOUT = 1, 2 = 300mA  $\rightarrow$  100 $\mu$ A

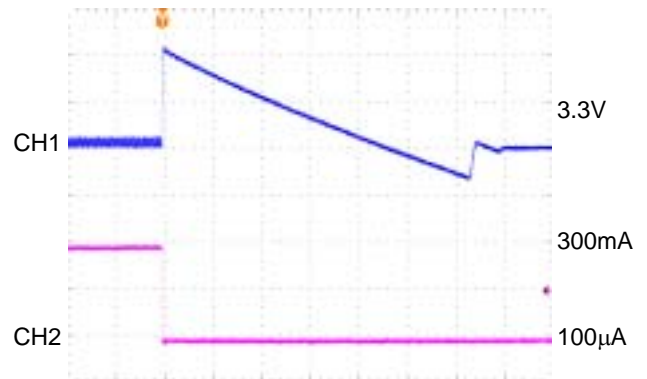

10msec / div

CH1 : VOUT1, 2, AC-COUPLED, 50mV/div  
CH2 : IOUT1, 2, 150mA/div

#### ○ PWM / PFM Switching Control

FOSC = 300kHz, VOUT1, 2 = 3.3V  
VIN = 5.0V, IOUT = 1, 2 = 100 $\mu$ A  $\rightarrow$  300mA

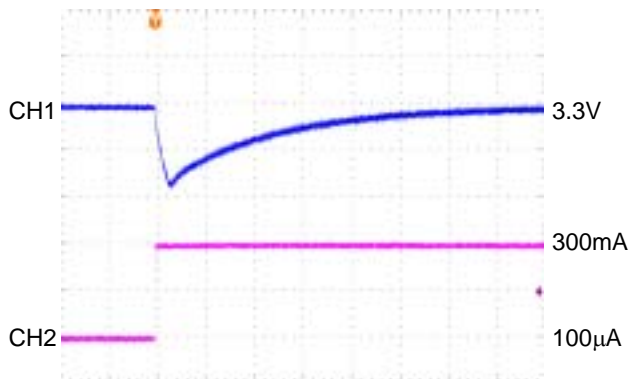

200 $\mu$ sec / div

CH1 : VOUT1, 2, AC-COUPLED, 100mV/div  
CH2 : IOUT1, 2, 150mA/div

FOSC = 300kHz, VOUT1, 2 = 3.3V  
VIN = 5.0V, IOUT = 1, 2 = 300mA  $\rightarrow$  100 $\mu$ A

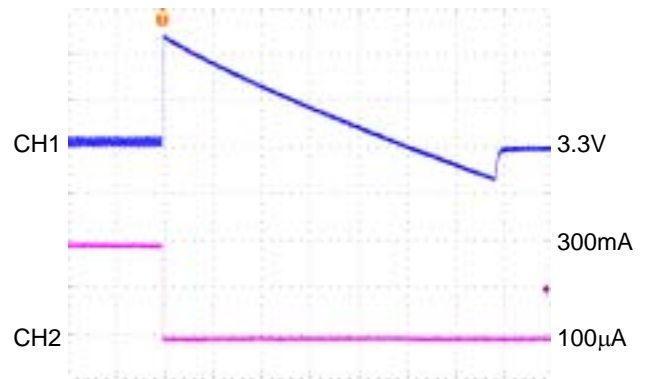

10msec / div

CH1 : VOUT1, 2, AC-COUPLED, 100mV/div  
CH2 : IOUT1, 2, 150mA/div

### ■ Load Transient Response

< VOUT1, 2 = 3.3 V, VIN = 5.0V IOUT1, 2 = 10mA ↔ 300mA >

#### ○ PWM Control

FOSC = 300kHz, VOUT1, 2 = 3.3V  
VIN = 5.0V, IOUT = 1, 2 = 10mA → 300mA

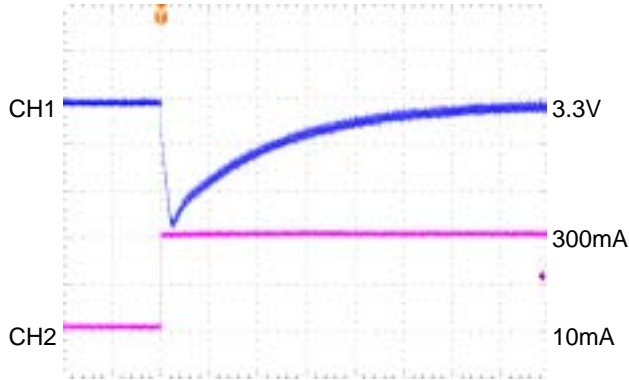

200µsec / div

CH1 : VOUT1, 2, AC-COUPLED, 50mV/div  
CH2 : IOUT1, 2, 150mA/div

FOSC = 300kHz, VOUT1, 2 = 3.3V  
VIN = 5.0V, IOUT = 1, 2 = 300mA → 10mA

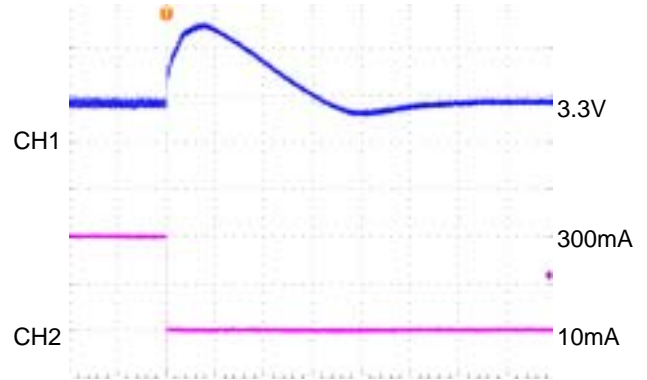

400µsec / div

CH1 : VOUT1, 2, AC-COUPLED, 50mV/div  
CH2 : IOUT1, 2, 150mA/div

#### ○ PWM / PFM Switching Control

FOSC = 300kHz, VOUT1, 2 = 3.3V  
VIN = 5.0V, IOUT = 1, 2 = 10mA → 300mA

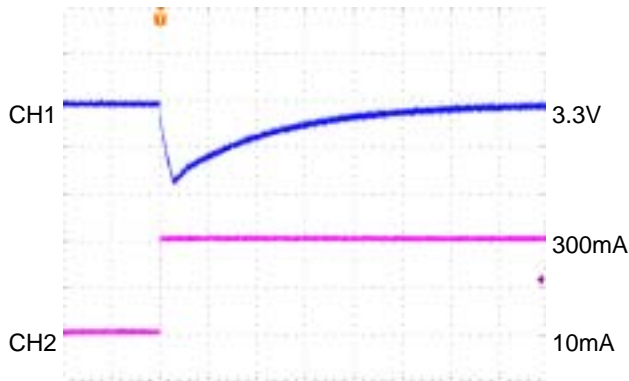

200µsec / div

CH1 : VOUT1, 2, AC-COUPLED, 100mV/div  
CH2 : IOUT1, 2, 150mA/div

FOSC = 300kHz, VOUT1, 2 = 3.3V  
VIN = 5.0V, IOUT = 1, 2 = 300mA → 10mA

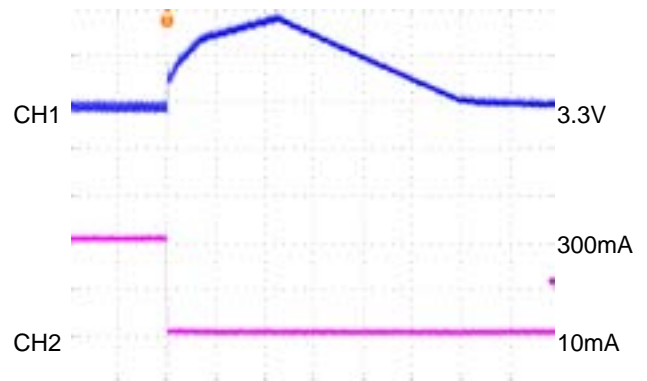

200µsec / div

CH1 : VOUT1, 2, AC-COUPLED, 50mV/div  
CH2 : IOUT1, 2, 150mA/div

### ■ Load Transient Response

< VOUT1, 2 = 0.9 V, VIN = 3.3V IOUT1, 2 = 100 $\mu$ A  $\leftrightarrow$  300mA >

#### ○ PWM Control

FOSC = 300kHz, VOUT1, 2 = 0.9V  
VIN = 3.3V, IOUT = 1, 2 = 100 $\mu$ A  $\rightarrow$  300mA

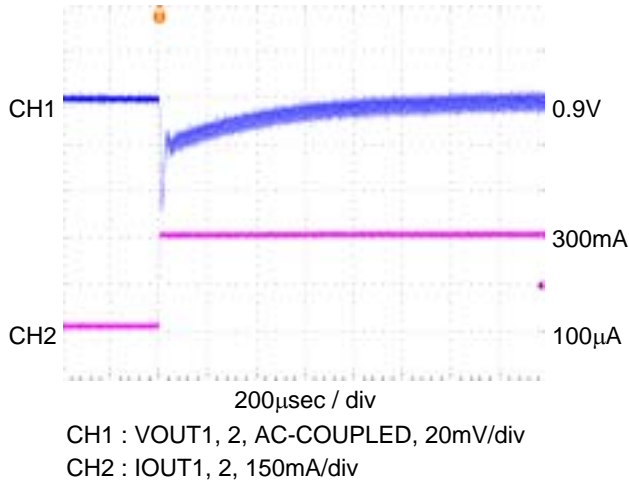

FOSC = 300kHz, VOUT1, 2 = 0.9V  
VIN = 3.3V, IOUT = 1, 2 = 300mA  $\rightarrow$  100 $\mu$ A

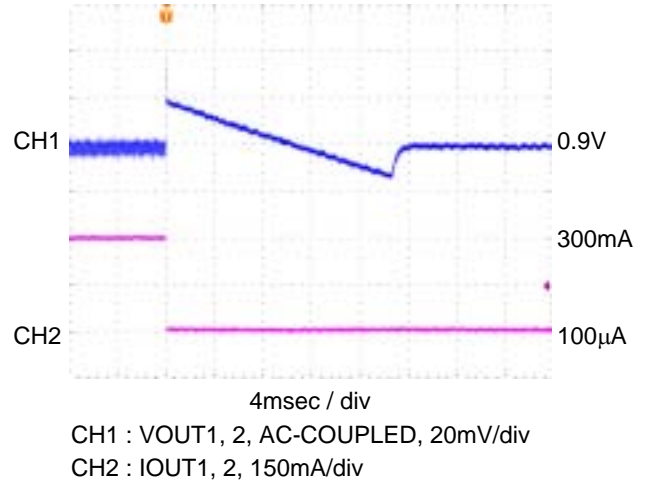

#### ○ PWM / PFM Switching Control

FOSC = 300kHz, VOUT1, 2 = 0.9V  
VIN = 3.3V, IOUT = 1, 2 = 100 $\mu$ A  $\rightarrow$  300mA

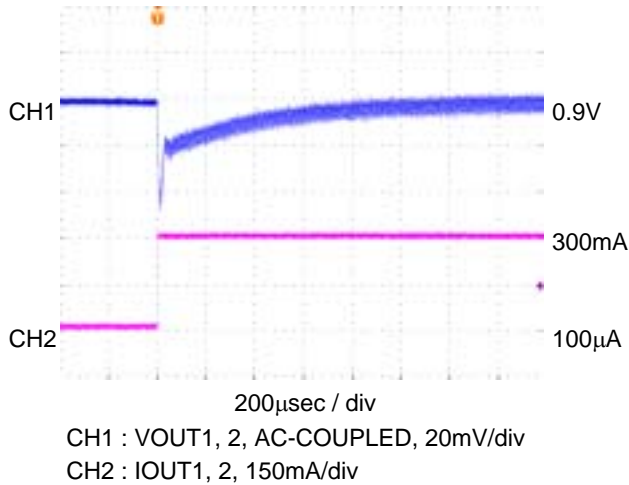

FOSC = 300kHz, VOUT1, 2 = 0.9V  
VIN = 3.3V, IOUT = 1, 2 = 300mA  $\rightarrow$  100 $\mu$ A

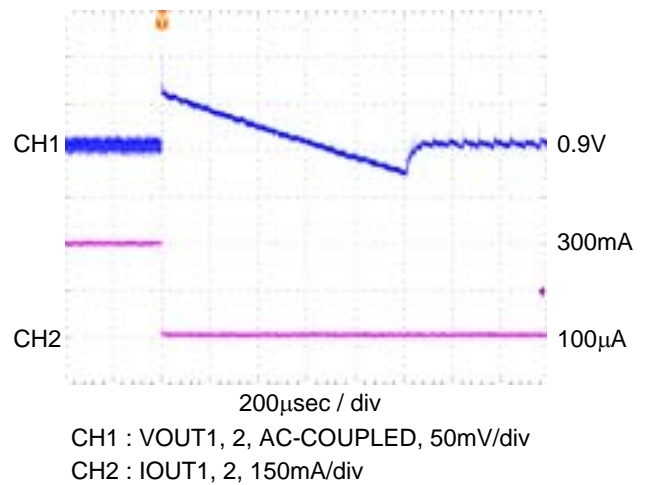

### ■ Load Transient Response

< VOUT1, 2 = 0.9 V, VIN = 3.3V IOUT1, 2 = 10mA ↔ 300mA >

#### ○ PWM Control

FOSC = 300kHz, VOUT1, 2 = 0.9V  
VIN = 3.3V, IOUT = 1, 2 = 10mA → 300mA

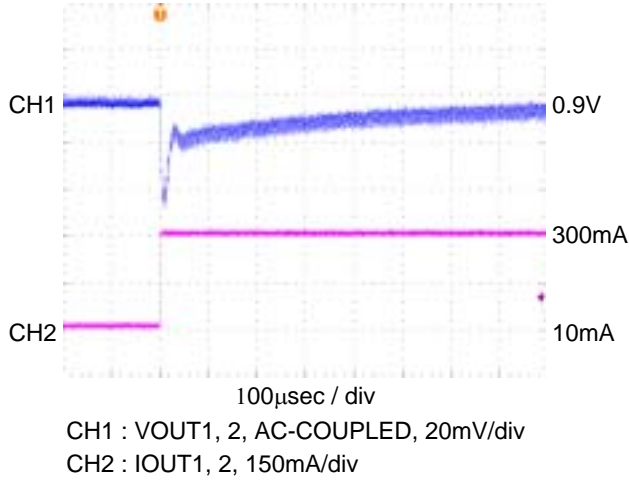

FOSC = 300kHz, VOUT1, 2 = 0.9V  
VIN = 3.3V, IOUT = 1, 2 = 300mA → 10mA

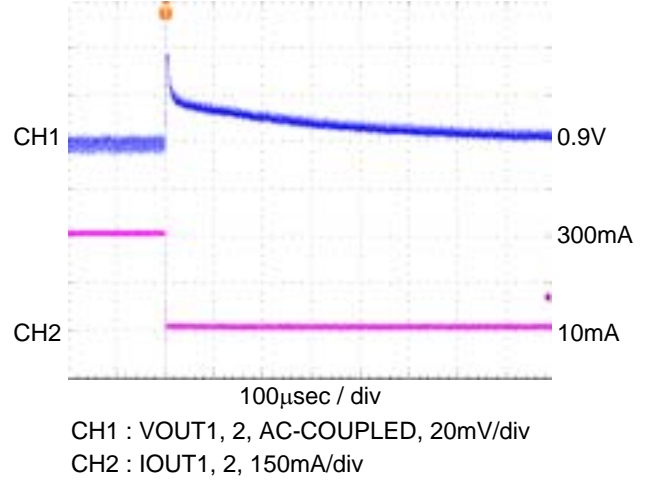

#### ○ PWM / PFM Switching Control

FOSC = 300kHz, VOUT1, 2 = 0.9V  
VIN = 3.3V, IOUT = 1, 2 = 10mA → 300mA

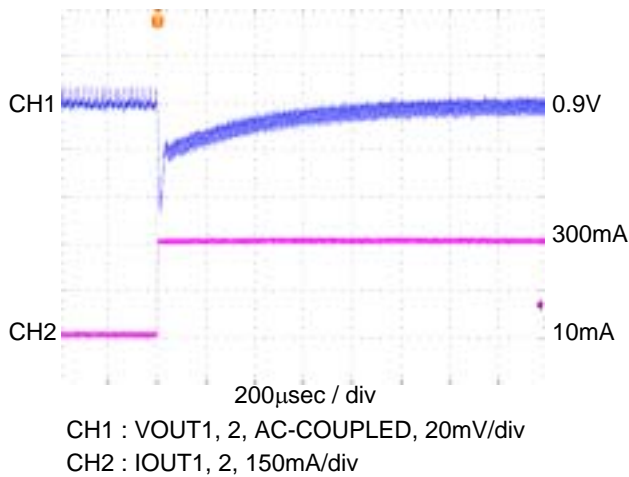

FOSC = 300kHz, VOUT1, 2 = 0.9V  
VIN = 3.3V, IOUT = 1, 2 = 300mA → 10mA

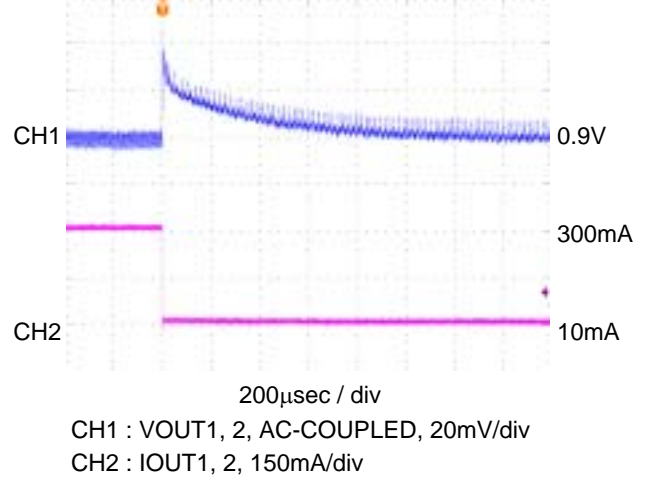

### ■ Load Transient Response

< PWM Control ↔ PWM / PFM Switching Control >

FOSC = 300kHz, VOUT1, 2 = 3.3V  
VIN = 5.0V, IOU1, 2 = 1, 2 = 5mA PWM1, 2 'Low' → 'High'

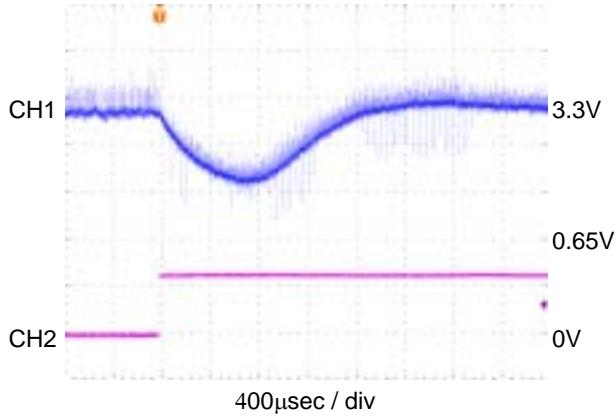

CH1 : VOUT1, 2, AC-COUPLED, 10mV/div  
CH2 : IOU1, 2, 0.5V/div

FOSC = 300kHz, VOUT1, 2 = 3.3V  
VIN = 5.0V, IOU1, 2 = 1, 2 = 5mA PWM1, 2 'High' → 'Low'

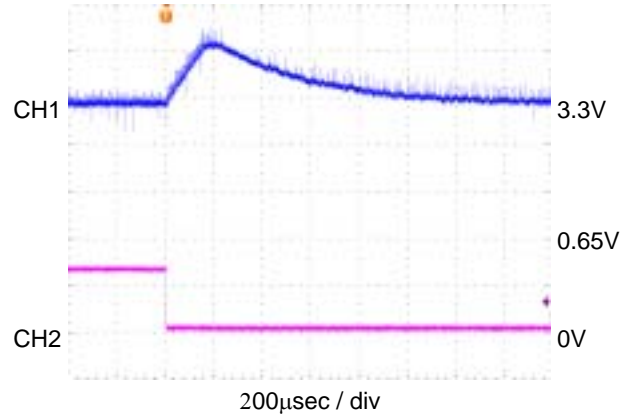

CH1 : VOUT1, 2, AC-COUPLED, 20mV/div  
CH2 : IOU1, 2, 0.5V/div

< Soft Start Wave Form >

FOSC = 300kHz, VOUT1, 2 = 3.3V  
VIN = 5.0V, IOU1, 2 = 1, 2 = 300mA EN1, 2 'Low' → 'High'  
CIN=47µF

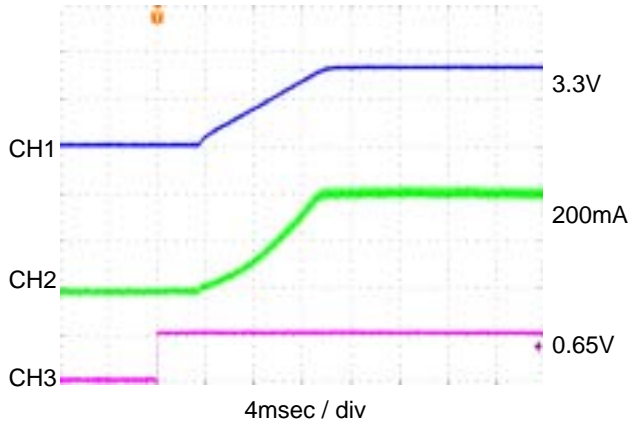

CH1 : VOUT1, 2, 2.0V/div  
CH2 : IIN1, 2, 100mA/div  
CH3 : EN1, 2, 0.5V/div

FOSC = 300kHz, VOUT1, 2 = 3.3V  
VIN = 5.0V, IOU1, 2 = 1, 2 = 100mA EN1, 2 'Low' → 'High'  
CIN=47µF

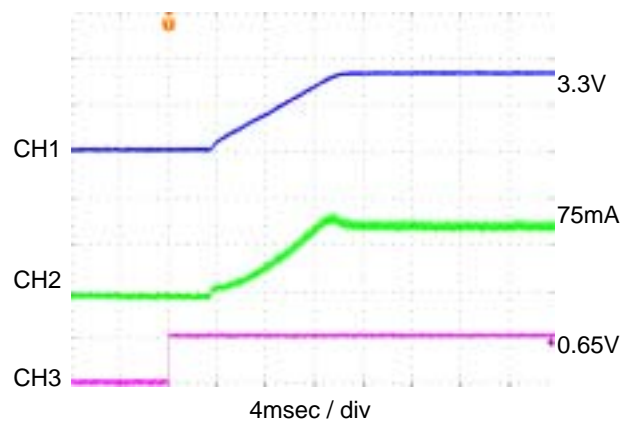

CH1 : VOUT1, 2, 2.0V/div  
CH2 : IIN1, 2, 50mA/div  
CH3 : EN1, 2, 0.5V/div

\* CH1 : EN2=GND when measurement  
CH2 : EN1=GND when measurement