



IMT2A

PNP EPITAXIAL SILICON TRANSISTOR

GENERAL PURPOSE DUAL TRANSISTOR

■ DESCRIPTION

The UTC **IMT2A** is a general purpose dual transistor within two chips in a SMT package.

■ FEATURES

* Two Chips in a SMT Package

■ EQUIVALENT CIRCUITS

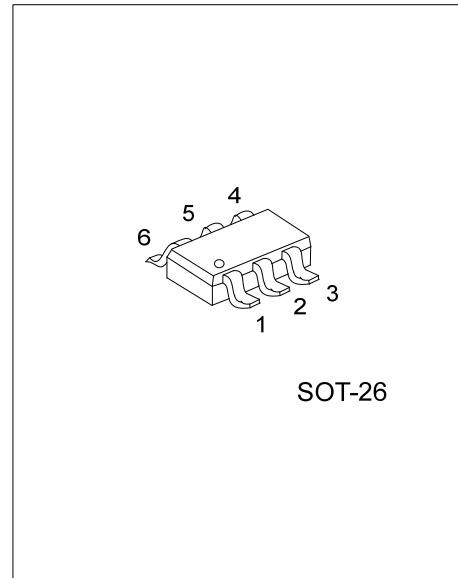
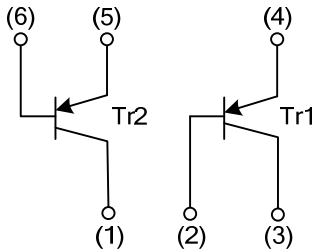

■ ORDERING INFORMATION

Order Number		Package	Pin Description						Packing
Lead Free	Halogen Free		1	2	3	4	5	6	
IMT2AL-AG6-R	IMT2AG-AG6-R	SOT-26	C2	B1	C1	E1	E2	B2	Tape Reel

<p>IMT2AL-AG6-T</p> <p>(1)Packing Type (2)Package Type (3)Lead Free</p>	<p>(1) R: Tape Reel (2) AG6: SOT-26 (3) G: Halogen Free, L: Lead Free</p>
---	---

■ MARKING

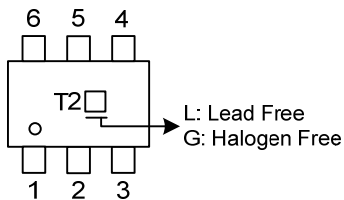

■ ABSOLUTE MAXIMUM RATING (T_A=25°C)

PARAMETER	SYMBOL	RATINGS	UNIT
Collector to Base Voltage	V _{CBO}	-60	V
Collector to Emitter voltage	V _{CEO}	-50	
Emitter to Base Voltage	V _{EBO}	-6	
Collector Current	I _C	-150	mA
Collector Power Dissipation (total)	P _C	300(Note)	mW
Junction Temperature	T _J	150	°C
Storage Temperature	T _{STG}	-55~ +150	

Note: 1. Absolute maximum ratings are those values beyond which the device could be permanently damaged.

Absolute maximum ratings are stress ratings only and functional device operation is not implied.

2. 200mW per element must not be exceeded.

■ ELECTRICAL CHARACTERISTICS (T_A=25°C)

PARAMETER	SYMBOL	TEST CONDITIONS	MIN	TYP	MAX	UNIT
Collector to Base Breakdown Voltage	BV _{CBO}	I _C = -50 μA	-60			V
Collector to Emitter Breakdown Voltage	BV _{CEO}	I _C = -1mA	-50			
Emitter to Base Breakdown Voltage	BV _{EBO}	I _E = -50 μA	-6			
Collector Cut Off Current	I _{CBO}	V _{CB} = -60 V			-0.1	μA
Emitter Cut Off Current	I _{EBO}	V _{EB} = -6 V			-0.1	
Collector to Emitter Saturation Voltage	V _{CE(SAT)}	I _C = -50 mA, I _B = -5 mA			-0.5	V
DC Forward Current Gain	h _{FE}	V _{CE} = -6 V, I _C = -1mA	120		560	
Transition Frequency	f _T	V _{CE} = -12V, I _E = 2mA, f = 100MHz (Note)		140		MHz
Output Capacitance	C _{OB}	V _{CB} = -12V, I _E = 0mA, f = 1MHz		4	5	pF

Note: Transition frequency of the device.

TYPICAL CHARACTERISTICS

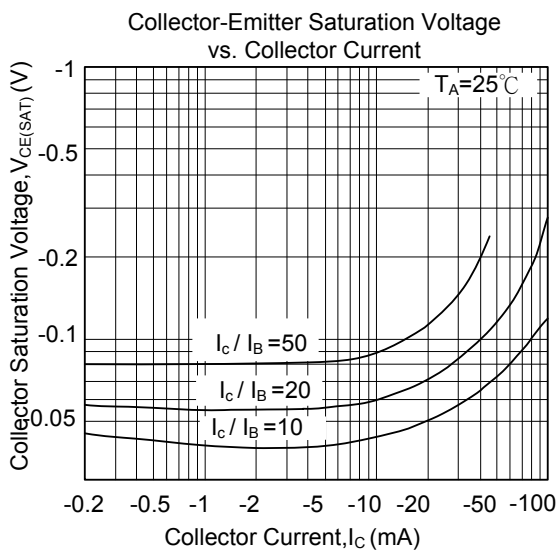
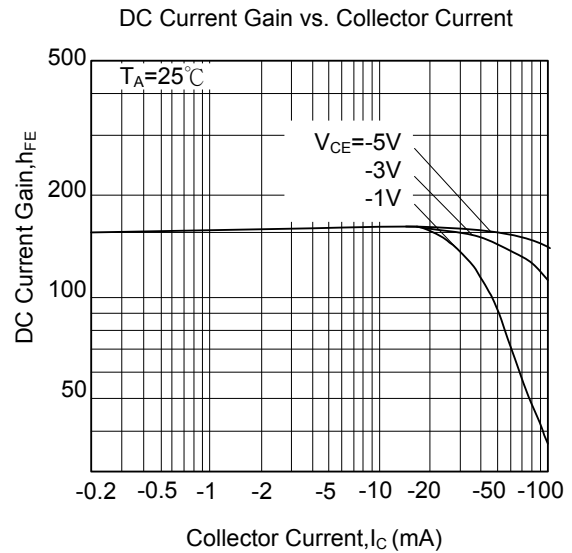
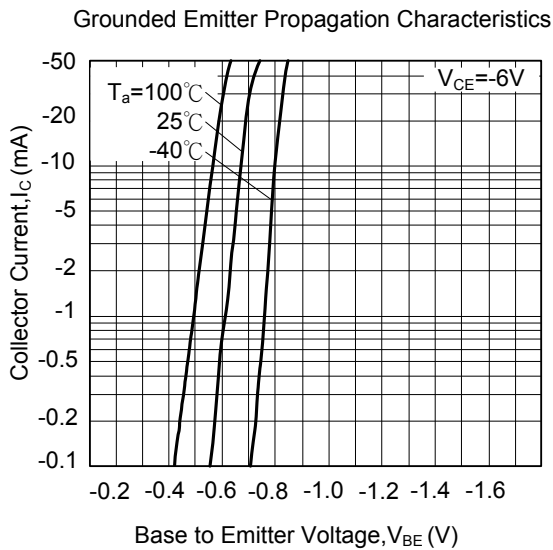
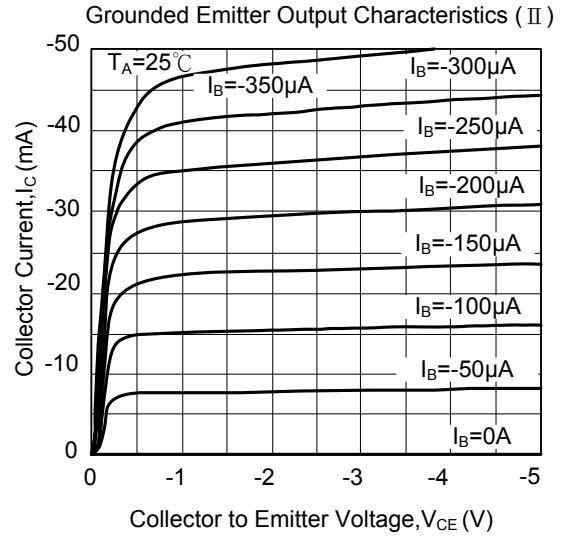
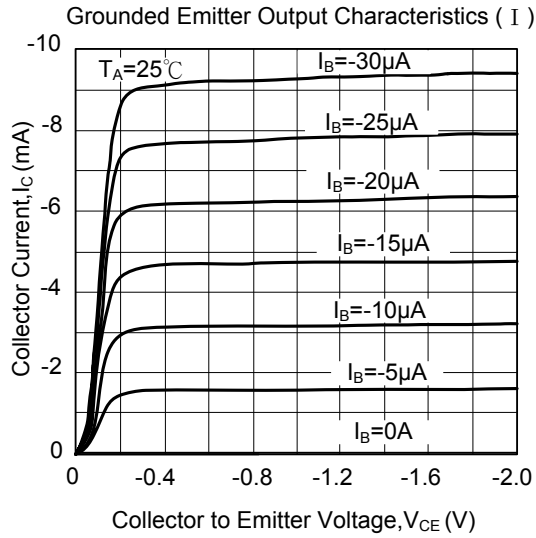

UTC assumes no responsibility for equipment failures that result from using products at values that exceed, even momentarily, rated values (such as maximum ratings, operating condition ranges, or other parameters) listed in products specifications of any and all UTC products described or contained herein. UTC products are not designed for use in life support appliances, devices or systems where malfunction of these products can be reasonably expected to result in personal injury. Reproduction in whole or in part is prohibited without the prior written consent of the copyright owner. The information presented in this document does not form part of any quotation or contract, is believed to be accurate and reliable and may be changed without notice.