

FAST DIODES

SUPER MAGN-A-pak™ Power Modules

Features

- High power FAST recovery diode series
- High current capability
- 3000 V_{RMS} isolating voltage with non-toxic substrate
- High surge capability
- High voltage ratings up to 2500V
- Industrial standard package
- UL E78996 approved 

460 A

Typical Applications

- Snubber for large GTO
- Snubber for large IGBT

Major Ratings and Characteristics

Parameters	IRKDL450..S20	Units
$I_{F(AV)}$	460	A
@ T_C	82	°C
$I_{F(RMS)}$	720	A
@ T_C	82	°C
I_{FSM}	@ 50Hz	13.0 KA
	@ 60Hz	13.8 KA
I^2t	@ 50Hz	845 KA ² s
	@ 60Hz	790 KA ² s
$I^2\sqrt{t}$		8450 KA ² √s
V_{RRM} range	1600 to 2500	V
t_{rr}	4.0	μs
T_{STG} range	-40 to 150	°C
T_J range	-40 to 150	°C

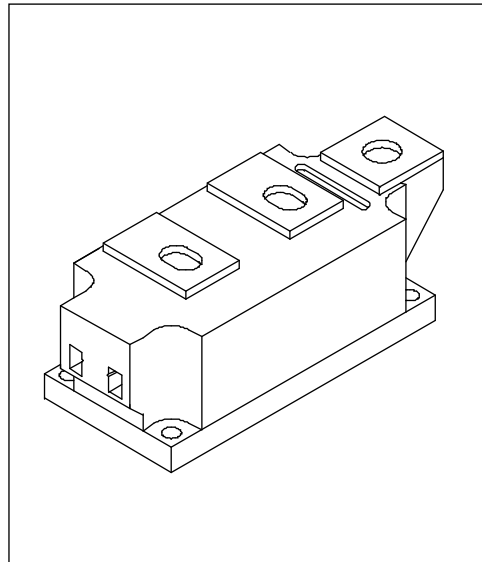

IRKDL450..S20 Series

Bulletin I27403 rev. A 09/97

International
IR Rectifier

ELECTRICAL SPECIFICATIONS

Voltage Ratings

Type number	Voltage Code	V_{RRM} , maximum repetitive peak reverse voltage V	V_{RSM} , maximum non-repetitive peak rev. voltage V	I_{RRM} max. @ T_J max. mA
IRKDL450..S20	16	1600	1700	50
	20	2000	2100	
	25	2500	2600	

Forward Conduction

Parameter	IRKDL450..	Units	Conditions
$I_{F(AV)}$ Maximum average forward current @ Case temperature	460	A	180° conduction, half sine wave
	82	°C	
$I_{F(RMS)}$ Maximum RMS forward current	720	A	180° conduction, half sine wave @ $T_C = 82^\circ\text{C}$
I_{FSM} Maximum peak, one-cycle forward, non-repetitive surge current	13.0	KA	t = 10ms No voltage
	13.8		t = 8.3ms reappplied
	11.1		t = 10ms 100% V_{RRM}
	11.8		t = 8.3ms reappplied
I^2t Maximum I^2t for fusing	845	KA ² s	t = 10ms No voltage
	790		t = 8.3ms reappplied
	616		t = 10ms 100% V_{RRM}
	578		t = 8.3ms reappplied
$I^2\sqrt{t}$ Maximum $I^2\sqrt{t}$ for fusing	8450	KA ² \sqrt{s}	t = 0.1 to 10ms, no voltage reappplied
$V_{F(TO)1}$ Low level value of threshold voltage	1.16	V	$(16.7\% \times \pi \times I_{F(AV)} < I < \pi \times I_{F(AV)})$, $T_J = T_J$ max.
$V_{F(TO)2}$ High level value of threshold voltage	1.62		$(I > \pi \times I_{F(AV)})$, $T_J = T_J$ max.
r_{f1} Low level value of forward slope resistance	0.68	m Ω	$(16.7\% \times \pi \times I_{F(AV)} < I < \pi \times I_{F(AV)})$, $T_J = T_J$ max.
r_{f2} High level value of forward slope resistance	0.41		$(I > \pi \times I_{F(AV)})$, $T_J = T_J$ max.
V_{FM} Maximum forward voltage drop	2.20	V	$I_{pk} = 1800\text{A}$, $T_J = 25^\circ\text{C}$, $t_p = 10\text{ms}$ sine pulse

Recovery Characteristics

Code	$T_J = 25^\circ\text{C}$ typical t_{rr} @ 25% I_{RRM} (μs)	Test conditions			Max. values @ $T_J = 150^\circ\text{C}$			
		I_{pk} Square Pulse (A)	di/dt (A/ μs)	V_r (V)	t_{rr} @ 25% I_{RRM} (μs)	Q_{rr} (μC)	I_{rr} (A)	
S20	2.0	1000	100	-50	4.0	400	180	

Blocking

Parameter	IRKDL450..	Units	Conditions
V_{INS} RMS isolation voltage	3000	V	t = 1 s
I_{RRM} Maximum peak reverse and off-state leakage current	50	mA	$T_J = T_J$ max., rated V_{RRM} applied

Thermal and Mechanical Specifications

Parameter	IRKDL450..	Units	Conditions
T_J Max. junction operating temperature range	- 40 to 150	°C	
T_{stg} Max. storage temperature range	- 40 to 150		
R_{thJC} Max. thermal resistance, junction to case	0.065	K/W	Per junction, DC operation
R_{thC-hs} Max. thermal resistance, case to heatsink	0.02	K/W	
T Mounting torque \pm 10%SMAP to heatsink busbar to SMAP	6 - 8	Nm	A mounting compound is recommended and the torque should be rechecked after a period of 3 hours to allow for the spread of the compound
	12 - 15		
wt Approximate weight	1500	g	
Case style	SUPER MAGN-A-pak		See outline table

ΔR_{thJC} Conduction

(The following table shows the increment of thermal resistance R_{thJC} when devices operate at different conduction angles than DC)

Conduction angle	Sinusoidal conduction	Rectangular conduction	Units	Conditions
180°	0.009	0.006	K/W	$T_J = T_J \text{ max.}$
120°	0.011	0.011		
90°	0.014	0.015		
60°	0.021	0.022		
30°	0.037	0.038		

Ordering Information Table

Device Code

IRK	D	L	450	-	25	S20
①	②	③	④		⑤	⑥

- 1 - Module type
- 2 - Circuit configuration D = 2 diodes in series
- 3 - Fast recovery
- 4 - Current rating
- 5 - Voltage code: Code x 100 = V_{RRM} (See Voltage Ratings Table)
- 6 - t_{rr} code (see Recovery Characteristics table)

Outline Table

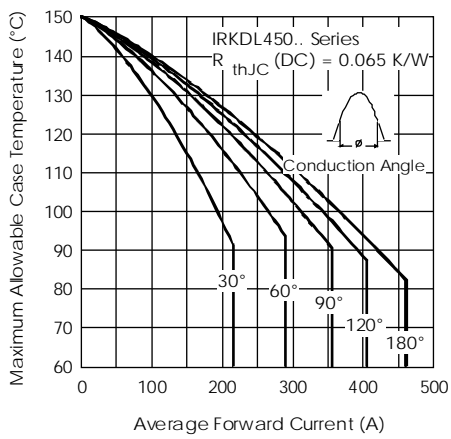
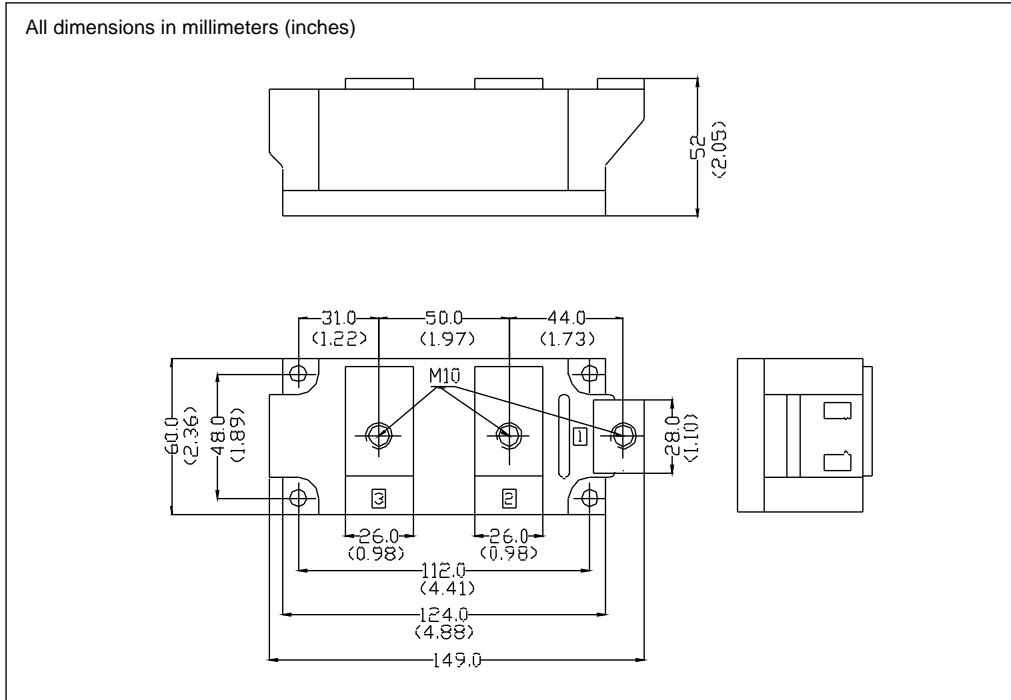

Fig. 1 - Current Ratings Characteristics

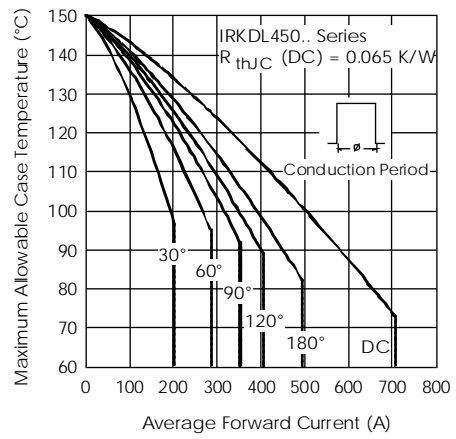

Fig. 2 - Current Ratings Characteristics

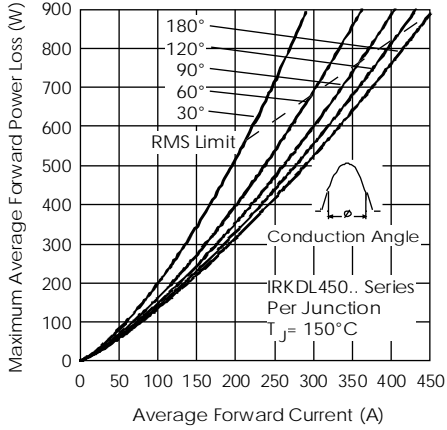

Fig. 3 - Forward Power Loss Characteristics

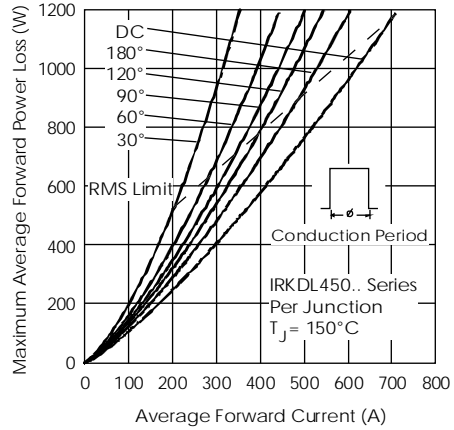

Fig. 4 - Forward Power Loss Characteristics

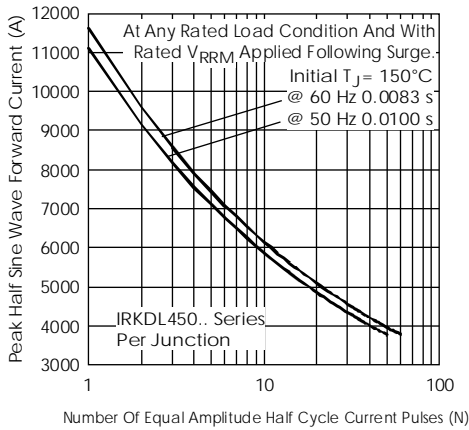

Fig. 5 - Maximum Non-Repetitive Surge Current

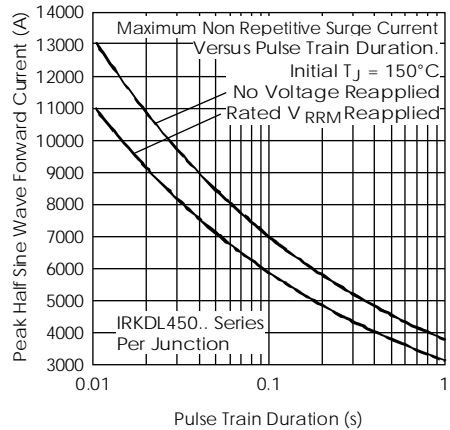

Fig. 6 - Maximum Non-Repetitive Surge Current

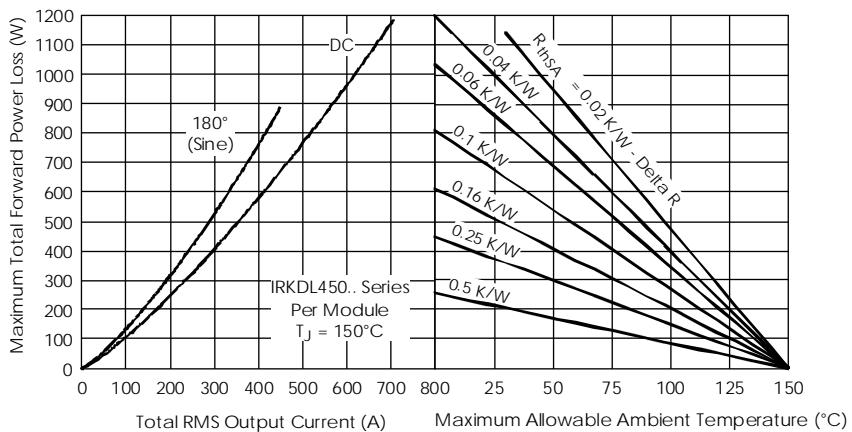

Fig. 7 - Forward Power Loss Characteristics

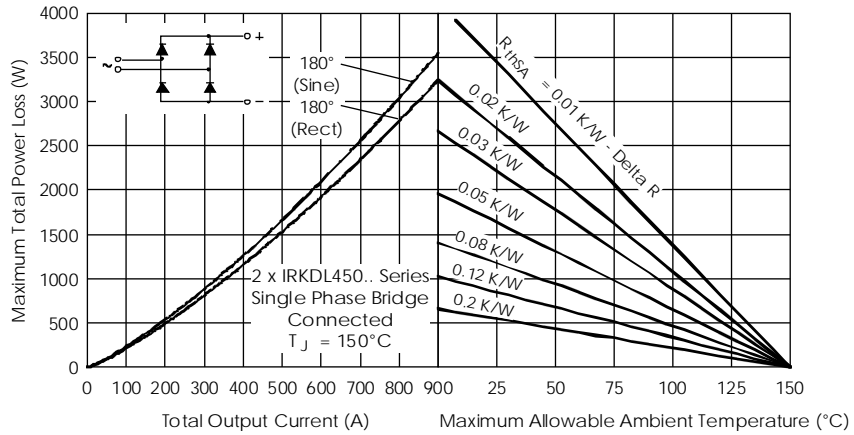

Fig. 8 - Forward Power Loss Characteristics

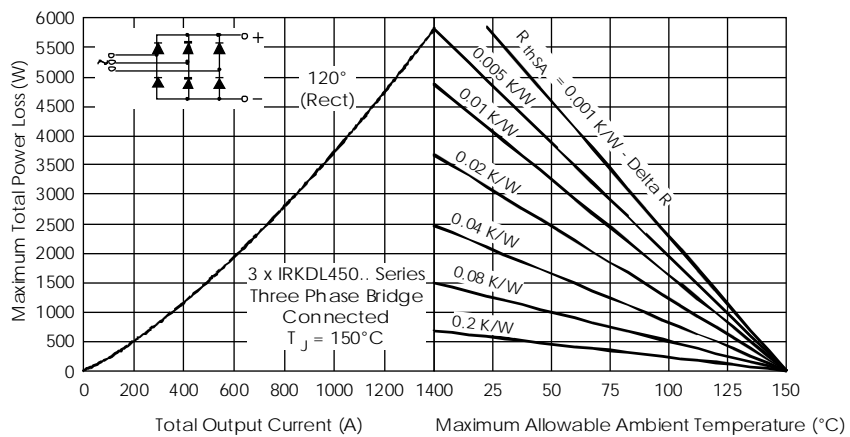

Fig. 9 - Forward Power Loss Characteristics

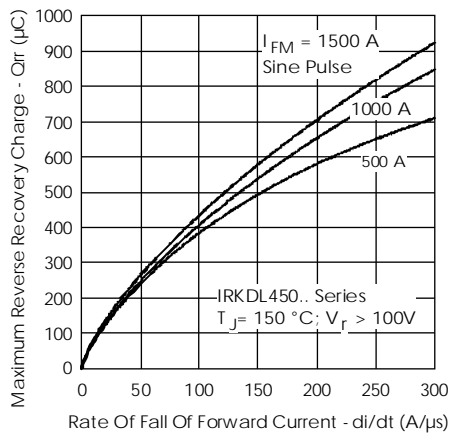

Fig. 10 - Recovery Charge Characteristics

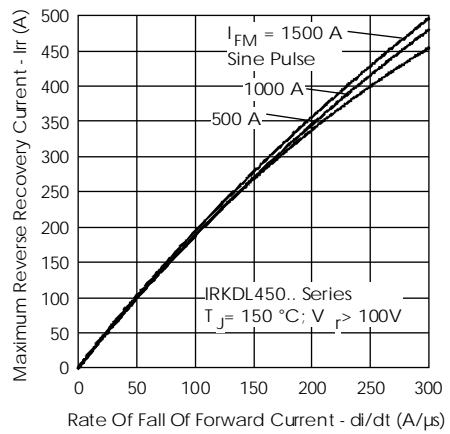

Fig. 11 - Recovery Current Characteristics

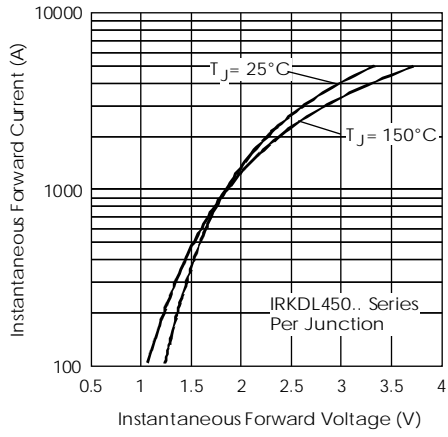

Fig. 12 - Forward Voltage Drop Characteristics

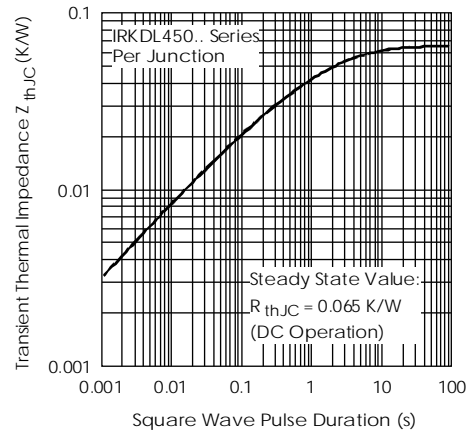

Fig. 13 - Thermal Impedance Z_{thJC} Characteristic