



# Frontier Electronics Corp.

667 E. COCHRAN STREET, SIMI VALLEY, CA 93065

TEL: (805) 522-9998 FAX: (805) 522-9989

E-mail: [frontiersales@frontierusa.com](mailto:frontiersales@frontierusa.com)

Web: <http://www.frontierusa.com>

## 16A DUAL ULTRA FAST RECOVERY RECTIFIER

### UFF160-005DT THRU UFF160-06DT

CASE: ITO-220AB (UFF160-XX) FULLY INSULATED PACKAGE

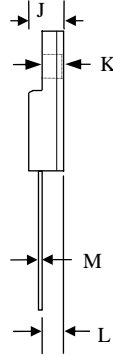
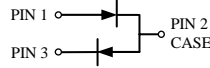
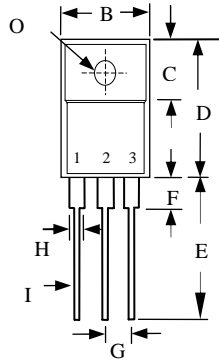

	MILLIMETERS	
	MIN	MAX
B	9.72	10.27
C	6.30	6.90
D	14.50	15.50
E	13.00	13.80
F	-	4.1
G	2.41	2.67
H	-	1.52
I	-	0.9
J	-	4.8
K	-	3.1
L	2.5	2.9
M	-	0.8
O	-	Ø 3.4

#### FEATURES

- ULTRA FAST RECOVERY TIME
- LOW FORWARD VOLTAGE
- LOW THERMAL RESISTANCE
- HIGH CURRENT CAPABILITY
- HIGH VOLTAGE
- GLASS PASSIVATED CHIP JUNCTION

#### MECHANICAL DATA

- CASE: TRANSFER MOLDED
- TERMINAL: MIL-STD-202F METHOD 208
- POLARITY: AS MARKED
- EPOXY: UL94V-0 FLAME RETARDANT MOLDING COMPOUND
- WEIGHT: 2.05 GRAMS

MAXIMUM RATINGS AND ELECTRICAL CHARACTERISTICS RATINGS AT 25°C AMBIENT TEMPERATURE UNLESS OTHERWISE SPECIFIED SINGLE PHASE, HALF WAVE, 60 HZ, RESISTIVE OR INDUCTIVE LOAD. FOR CAPACITIVE LOAD, DERATE CURRENT BY 20%

RATINGS	SYMBOL	UFF160-005DT	UFF160-01DT	UFF160-015DT	UFF160-02DT	UFF160-03DT	UFF160-04DT	UFF160-05DT	UFF160-06DT	UNITS
MAXIMUM RECURRENT PEAK REVERSE VOLTAGE	$V_{RRM}$	50	100	150	200	300	400	500	600	V
MAXIMUM RMS VOLTAGE	$V_{RMS}$	35	70	105	140	210	280	350	420	V
MAXIMUM DC BLOCKING VOLTAGE	$V_{DC}$	50	100	150	200	300	400	500	600	V
MAXIMUM AVERAGE FORWARD RECTIFIED CURRENT SEE FIG.1	$I_O$	16.0								A
PEAK FORWARD SURGE CURRENT, 8.3ms SINGLE HALF SINE-WAVE SUPERIMPOSED ON RATED LOAD	$I_{FSM}$	200								A
TYPICAL JUNCTION CAPACITANCE (NOTE 1)	$C_J$	65								PF
TYPICAL THERMAL RESISTANCE (NOTE 2)	$R_{\theta jc}$	2.2								°C/W
STORAGE TEMPERATURE RANGE	$T_{STG}$	- 55 TO + 150								°C
OPERATING TEMPERATURE RANGE	$T_{OP}$	- 55 TO + 150								°C

#### ELECTRICAL CHARACTERISTICS ( $A_T T_A = 25^\circ\text{C}$ UNLESS OTHERWISE NOTED)

CHARACTERISTICS	SYMBOL	UFF160-005DT	UFF160-01DT	UFF160-015DT	UFF160-02DT	UFF160-03DT	UFF160-04DT	UFF160-05DT	UFF160-06DT	UNITS	
MAXIMUM FORWARD VOLTAGE AT 8A PER LEG	$V_F$	0.95			1.3		1.5			V	
MAXIMUM DC REVERSE CURRENT AT $T_A = 25^\circ\text{C}$	$I_R$	10								$\mu\text{A}$	
MAXIMUM DC REVERSE CURRENT AT $T_A = 100^\circ\text{C}$	$I_R$	100								$\mu\text{A}$	
MAXIMUM REVERSE RECOVERY TIME (NOTE 3)	$T_{RR}$	35				50					nS

- NOTES: 1. MEASURED AT 1 MHZ AND APPLIED REVERSE VOLTAGE OF 4.0 VOLTS  
 2. THERMAL RESISTANCE JUNCTION TO CASE PER LEG MOUNTED ON HEAT SINK  
 3. REVERSE RECOVERY TEST CONDITIONS:  $I_F = 0.5\text{A}$ ,  $I_R = 1.0\text{A}$ ,  $I_{RR} = 0.25\text{A}$

# RATINGS AND CHARACTERISTIC CURVE UFF160-005DT THRU UFF160-06DT

FIG. 1 -TEST CIRCUIT DIAGRAM AND REVERSE RECOVERY TIME CHARACTERISTIC

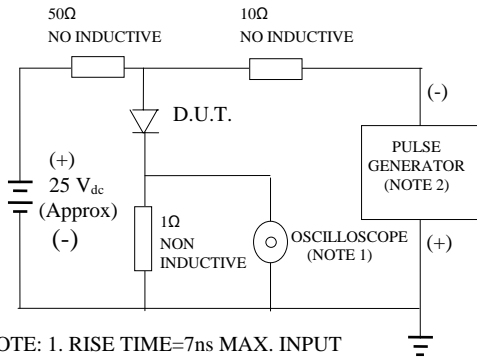

NOTE: 1. RISE TIME=7ns MAX. INPUT IMPEDANCE=1 MOhms 22PF  
2. RISE TIME =10 ns MAX. SOURCE IMPEDANCE=50 OHMS

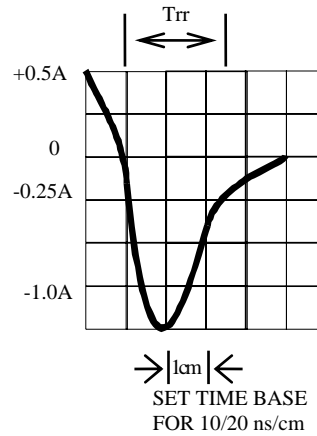

FIG. 2 -TYPICAL FORWARD CURRENT DERATING CURVE

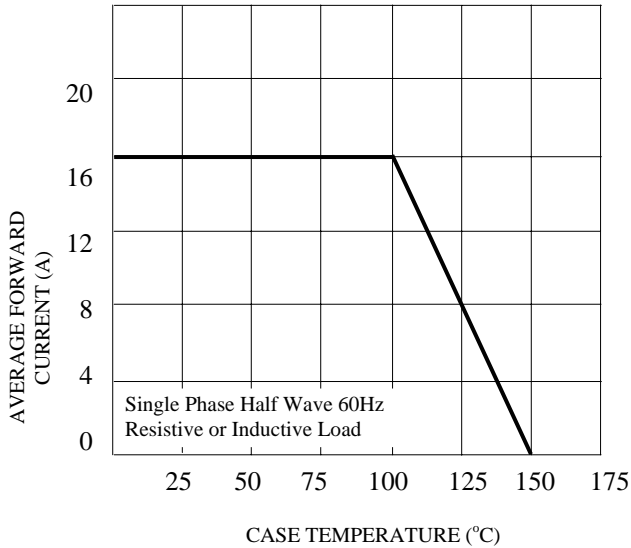

FIG. 3 -TYPICAL INSTANTANEOUS FORWARD CHARACTERISTICS

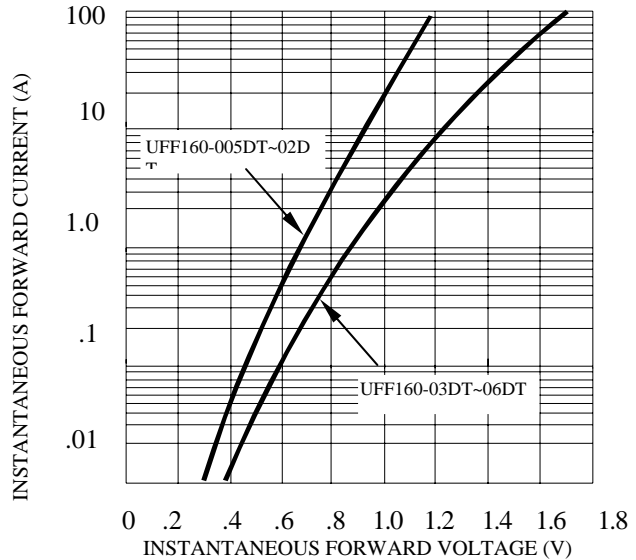

FIG. 4 -TYPICAL REVERSE CHARACTERISTICS

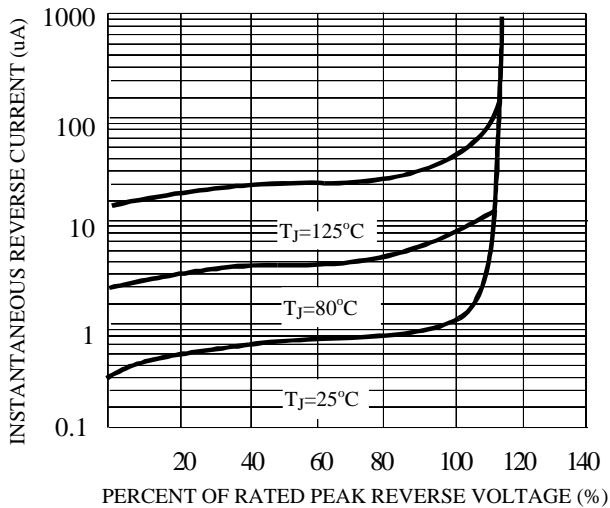

FIG. 5 -TYPICAL JUNCTION CAPACITANCE

