

GTC9926E

N-CHANNEL ENHANCEMENT MODE POWER MOSFET

BVDSS	20V
RDS(ON)	28mΩ
ID	4.6A

Description

The GTC9926E provides the designer with the best combination of fast switching, ruggedized device design, ultra low on-resistance and cost-effectiveness.

Features

- *Low on-resistance
- *Capable of 2.5V gate drive
- *Low drive current
- *Surface mount package

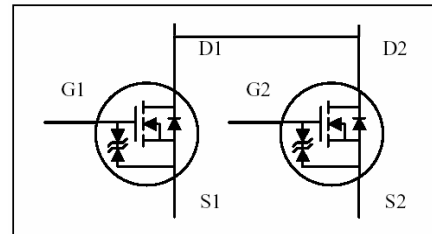

Package Dimensions

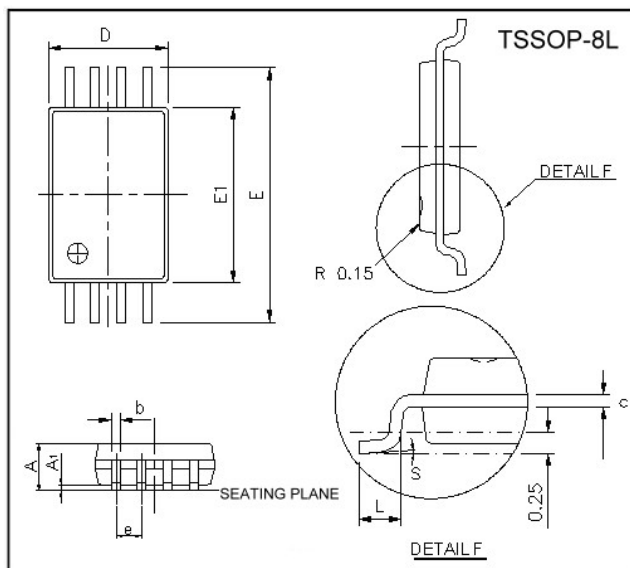

Marking:

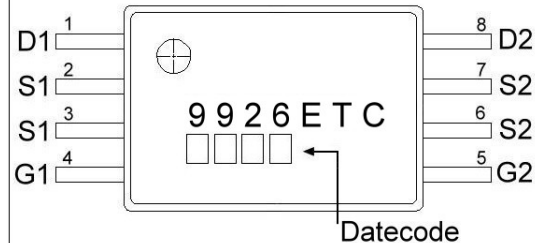

REF.	Millimeter		REF.	Millimeter	
	Min.	Max.		Min.	Max.
A	-	1.20	E	6.20	6.60
A1	0.05	0.15	E1	4.30	4.50
b	0.19	0.30	e	0.65 BSC	
c	0.09	0.20	L	0.45	0.75
D	2.90	3.10	S	0°	8°

Absolute Maximum Ratings

Parameter	Symbol	Ratings	Unit
Drain-Source Voltage	V_{DS}	20	V
Gate-Source Voltage	V_{GS}	±12	V
Continuous Drain Current ³ , $V_{GS}@10V$	$I_D @TA=25^{\circ}C$	4.6	A
Continuous Drain Current ³ , $V_{GS}@10V$	$I_D @TA=70^{\circ}C$	3.7	A
Pulsed Drain Current ^{1,2}	I_{DM}	20	A
Total Power Dissipation	$P_D @Ta=25^{\circ}C$	1	W
Linear Derating Factor		0.008	W/°C
Operating Junction and Storage Temperature Range	T_j, T_{stg}	-55 ~ +150	°C

Thermal Data

Parameter	Symbol	Value	Unit
Thermal Resistance Junction-ambient Max.	R_{thj-a}	125	°C/W

Electrical Characteristics (T_j = 25°C unless otherwise specified)

Parameter	Symbol	Min.	Typ.	Max.	Unit	Test Conditions
Drain-Source Breakdown Voltage	BV _{DSS}	20	-	-	V	V _{GS} =0, I _D =250uA
Breakdown Voltage Temperature Coefficient	$\Delta BV_{DSS} / \Delta T_j$	-	0.1	-	V/°C	Reference to 25°C, I _D =1mA
Gate Threshold Voltage	V _{GS(th)}	0.5	-	-	V	V _{DS} =V _{GS} , I _D =250uA
Forward Transconductance	g _{fs}	-	9.7	-	S	V _{DS} =10V, I _D =4.6A
Gate-Source Leakage Current	I _{GSS}	-	-	±10	uA	V _{GS} = ±10V
Drain-Source Leakage Current(T _j =25°C)	I _{DSS}	-	-	1	uA	V _{DS} =20V, V _{GS} =0
Drain-Source Leakage Current(T _j =70°C)		-	-	25	uA	V _{DS} =20V, V _{GS} =0
Static Drain-Source On-Resistance	R _{DS(ON)}	-	-	28	mΩ	V _{GS} =4.5V, I _D =4A
		-	-	40		V _{GS} =2.5V, I _D =2A
Total Gate Charge ²	Q _g	-	12.5	-	nC	I _D =4.6A V _{DS} =20V V _{GS} =5V
Gate-Source Charge	Q _{gs}	-	1	-		
Gate-Drain ("Miller") Change	Q _{gd}	-	6.5	-		
Turn-on Delay Time ²	T _{d(on)}	-	820	-	ns	V _{DS} =10V I _D =1A V _{GS} =4.5V R _G =6Ω R _D =10Ω
Rise Time	T _r	-	934	-		
Turn-off Delay Time	T _{d(off)}	-	860	-		
Fall Time	T _f	-	510	-		
Input Capacitance	C _{iss}	-	231	-	pF	V _{GS} =0V V _{DS} =10V f=1.0MHz
Output Capacitance	C _{oss}	-	164	-		
Reverse Transfer Capacitance	C _{rss}	-	137	-		

Source-Drain Diode

Parameter	Symbol	Min.	Typ.	Max.	Unit	Test Conditions
Forward On Voltage ²	V _{SD}	-	-	1.2	V	I _S =1.25, V _{GS} =0V, T _j =25°C
Continuous Source Current(Body Diode)	I _S	-	-	1.25	A	V _D = V _G =0V, V _S =1.2V
Continuous Source Current(Body Diode) ¹	I _{SM}	-	-	20	A	

- Notes: 1. Pulse width limited by Max. junction temperature.
2. Pulse width ≤ 300us, duty cycle ≤ 2%.
3. Surface mounted on FR4 board, t ≤ 10sec.

Characteristics Curve

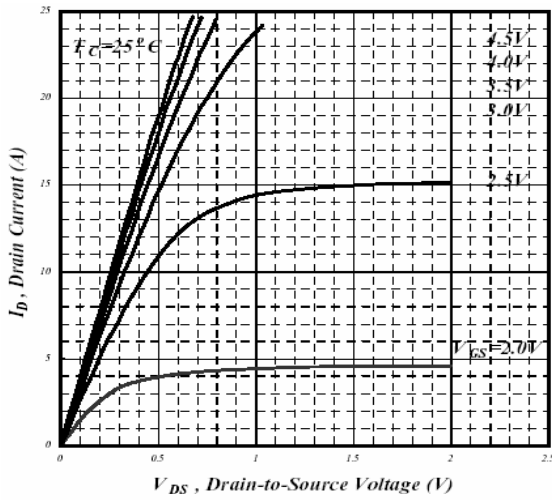

Fig 1. Typical Output Characteristics

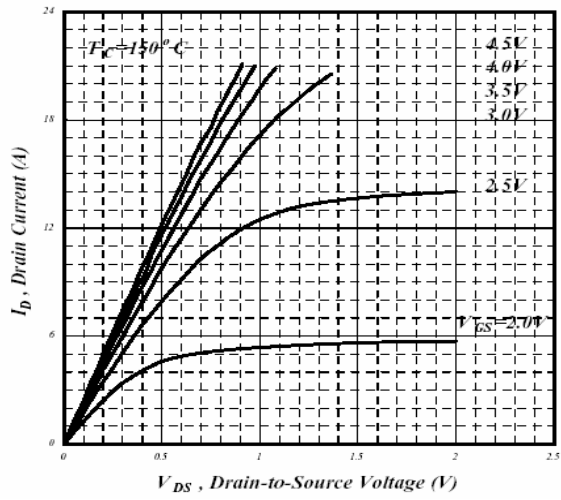

Fig 2. Typical Output Characteristics

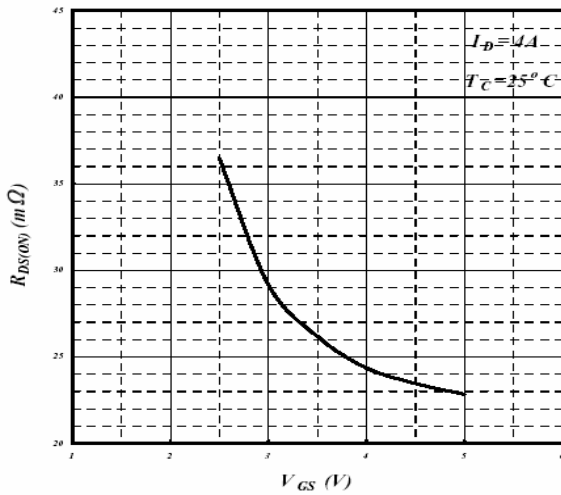

Fig 3. On-Resistance v.s. Gate Voltage

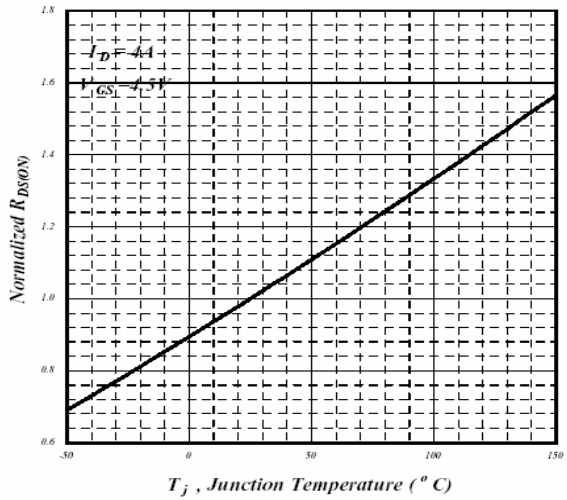

Fig 4. Normalized On-Resistance v.s. Junction Temperature

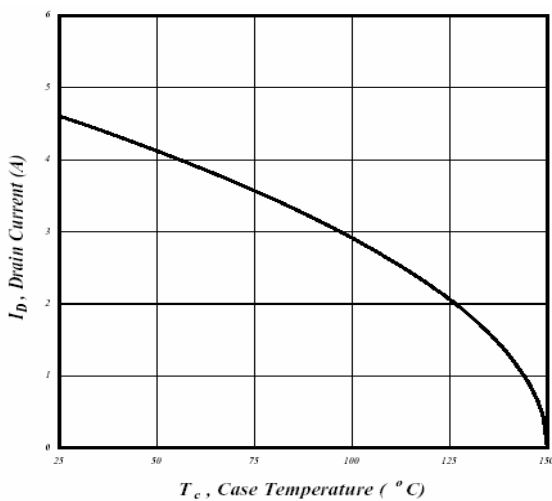

Fig 5. Maximum Drain Current v.s. Case Temperature

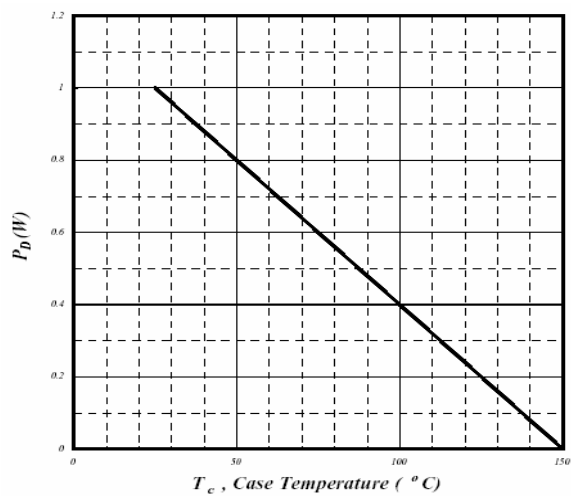

Fig 6. Type Power Dissipation

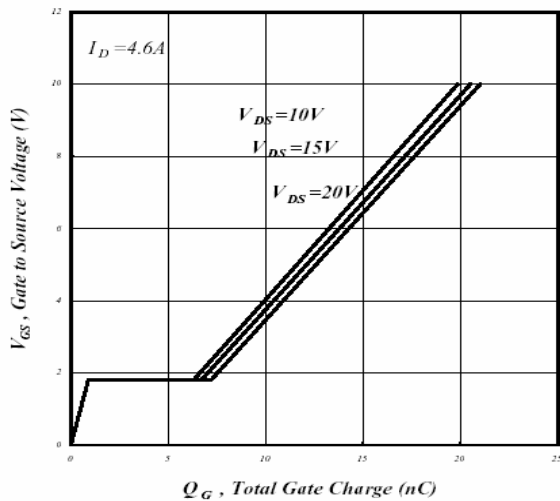

Fig 7. Gate Charge Characteristics

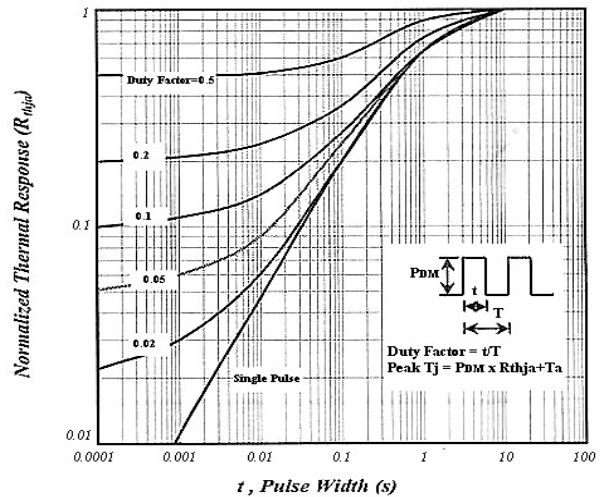

Fig 8. Effective Transient Thermal Impedance

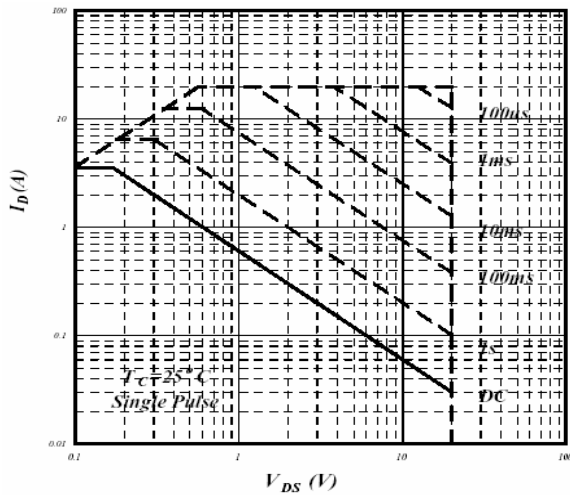

Fig 9. Maximum Safe Operating Area

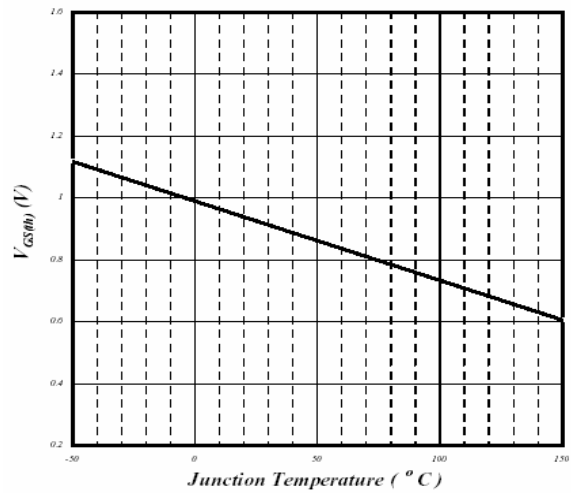

Fig 10. Gate Threshold Voltage v.s. Junction Temperature

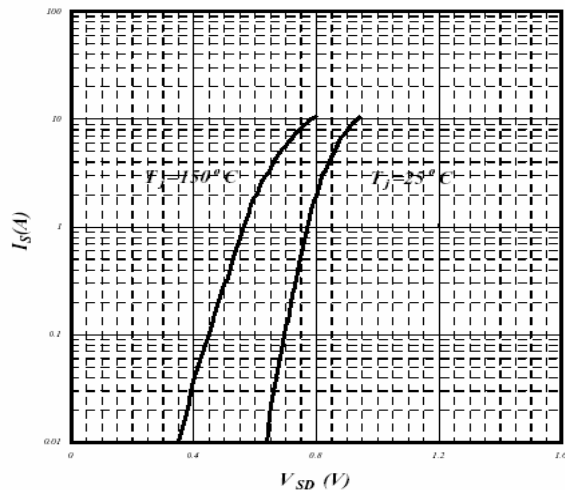

Fig 11. Forward Characteristics of Reverse Diode

Important Notice:

- All rights are reserved. Reproduction in whole or in part is prohibited without the prior written approval of GTM.
- GTM reserves the right to make changes to its products without notice.
- GTM semiconductor products are not warranted to be suitable for use in life-support Applications, or systems.
- GTM assumes no liability for any consequence of customer product design, infringement of patents, or application assistance.

Head Office And Factory:

- Taiwan:** No. 17-1 Tatung Rd. Fu Kou Hsin-Chu Industrial Park, Hsin-Chu, Taiwan, R. O. C.
- TEL : 886-3-597-7061 FAX : 886-3-597-9220, 597-0785
- China:** (201203) No.255, Jang-Jiang Tsai-Lueng RD. , Pu-Dung-Hsin District, Shang-Hai City, China
- TEL : 86-21-5895-7671 ~ 4 FAX : 86-21-38950165