



Phihong Midspan POE with TCPIP (SNMPv2c)

User Manual

TCPIP (SNMPv2c) Rev 1.6

PES12779

Compliant Models:

POE75U-1UP-N-R
POE240U-1MP-N-R
POE240U-2MP-N-R
POE125U-4AT-N-R
POE240U-4UP-N-R
POE576U-4MP-N-R
POE576U-8UP-N-R
POE806U-8MP-N-R



Disclaimer

Phihong accepts no accountability or liability arising from the use of the Midspans, as described in this document. The handling of equipment will be users' responsibility. Applications described in this document are for descriptive purposes only. Phihong does not provide warranty on modified products.

Notice

This document contains informative information about the software and hardware used on the Mid-span. The information is held to be accurate and reliable from time of print. Please be advised that product development and revisions are still in course of action. Phihong cannot be held responsible for involuntary error, exclusions, inaccuracies, or following changes of printed material.

Phihong reserves the right to make changes to products and to their specifications as described in this document, at any time, without prior notice. The contents of this document may not be photocopied or reproduced in any form without written permission of Phihong.

NOTE: Midspans are for indoor use only!

© August 2009 Phihong USA Corp.
All Rights Reserved.

This document is subject to change without notice.



Contents

Overview	5
1. Safety Procedures	6
1.1. General Precautions	6
2. Midspan Hardware Setup	8
2.1. Physical Hardware Appearance	8
2.2. Connecting Ethernet Cables	11
2.3. Midspan Accessories	14
2.4. Powering Up Midspan	15
2.5. LED Indicators	16
2.6. Technical Specifications	17
3. Midspan Monitoring and Control --- HTTP Protocol	18
3.1. Port Control Webpage	18
3.2. Administrative Management Webpage	21
3.3. Network Settings Webpage	21
3.4. SNMP Community String Webpage	23
3.5. System Tools Webpage	24
4. Midspan Monitoring and Control with MIB Browser --- SNMP Protocol	26
4.1. Structure of Management Information (SMI) of Phihong Midspan	26
4.2. Phihong Midspan MIB	28
4.3. Notes for Using Phihong Midspan MIB	32
4.4. Using MG-SOFT MIB Browser to run Phihong Midspan	33
5. Field Firmware Updating	39
5.1. Updating Microprocessor Flash Contents with POEA-x.x.bin	39
5.2. Updating EEPROM Contents with POEB-x.x.bin	42
6. Troubleshooting	44
7. Frequently Asked Questions	45



List of Figures

Figure 1 – Single Port Midspan Ports	8
Figure 2 – Single Port Midspan AC Input	8
Figure 3 – Small Frame Multiport Midspan Ports	9
Figure 4 – Small Frame Multiport Midspan AC Input	9
Figure 5 – 1U Multiport Midspan Ports	10
Figure 6 – 1U Multiport Midspan AC Input	10
Figure 7 – Single Port Midspan SNMP Connection	11
Figure 8 – Single Port Midspan Data and PoE Connections	11
Figure 9 – Small Frame Multiport Midspan SNMP Connection	12
Figure 10 – Small Frame Multiport Midspan PoE Connections	12
Figure 11 – 1U Multiport Midspan SNMP Connection	13
Figure 12 – 1U Multiport Midspan POE Connections	13
Figure 13 – Single Unit Rack Mount	14
Figure 14 – Two Units in Side by Side Rack Mounting	14
Figure 15 – 19” Midspan Rack Mount	14
Figure 16 – Rack Mounting Brackets and Screws	14
Figure 17 – AC Cord	14
Figure 18 – Management Set-up Diagram	18
Figure 19 – Port Control Webpage	18
Figure 20 – Administrative Management Webpage	21
Figure 21 – Network Settings Webpage	22
Figure 22 – Reboot Webpage	23
Figure 23 – SNMP Community Strings Webpage	23
Figure 24 – System Tools Webpage	25
Figure 25 – Phihong Midspan SMI	26
Figure 26 – Phihong Midspan SMI Continued	27
Figure 27 – Generate Phihong SNMPv2c MIB Module	33
Figure 28 – Set SNMP Protocol to contact remote SNMP Agent	35
Figure 29 – Phihong Midspan MIB Tree	36
Figure 30 – Set IP Address of Trap Receiver	37
Figure 31 – Trap Ringer Console	38
Figure 32 – TFTP Uploading Using Application Entry Mode	40
Figure 33 – Set Static IP in Internet Protocol (TCP/IP) Properties Window	41
Figure 34 – Upload in Internet Explorer	42
Figure 35 – Software Update Successful Window	42
Figure 36 – Upload Using System Tools on Web Interface	43



Overview

Phihong's midspans are Power over Ethernet (PoE) injectors with output options ranging from 15.4W to 95W per port. Available with 1, 2, 4, 8, 16 or 24 ports, Phihong's midspans put out full power every port with no need to manage power across ports.

By using the SNMPv2C (Simple Networking Management Protocol version 2C) protocol, users can monitor and control the port status over their internet browser. Linking an Ethernet cable between their midspan and management computer, locally or otherwise through a network switch, users may manage certain functions including remote reset of powered devices. Users may connect to their midspan using the DHCP client on the midspan which will create a dynamic hostname and IP address unique to the network. Otherwise a Static IP address may be created by the user.

Internet browsers that users may choose from to access their Phihong midspans including: Internet Explorers 7 and 8 found on Windows XP, Windows Vista and Windows 7. Mozilla Firefox, Google Chrome, Opera and Safari may also be used. To update the firmware on your midspan, only Microsoft XP or Vista may be used at this time. Please check www.phihong.com or www.midspans.com for support updates or contact us at poe@phihongusa.com for additional questions regarding compatibility. For SNMO interface, users may refer to the SNMP console manual for PC requirements.

A default username and password come preset on your Phihong midspan. Entering "admin" in both fields will allow users to gain access to customize their security settings. The default read-only community string is "Phihong_read_only" and users may enter "Phihong" for the read-write community field. Select tools that users may access through Phihong's management interface is port control (i.e. turn on/off), change access strings (hostname, username, password etc.), and set IP Address to dynamic DHCP to allow it to be set automatically or Static as customized by the user. Additionally, users may configure and send SNMPv2C TRAPs which are triggered on changes to port status.

Phihong may release new firmware and updates at any time, so it is advised to check our websites regularly for any updates that may affect your midspan. For the models listed on the cover page, two firmware files are used. The first is POEA-x.x.x.bin which is uploaded to an internal microprocessor under Windows TFTP command. The second is POEB-x.x.x.bin which is uploaded directly into an internal EEPROM by entering <http://hostmane/upload> into your internet browser or by using web <system tools>.

More detailed instruction may be found in this manual.



1. Safety Procedures

1.1. General Precautions

General – Please read the following precautions carefully before installing and connecting the system to a power source.

Note – Only qualified and trained service personnel (in accordance with IEC 60950 and AS/NZS 3260) should install, replace, or service the equipment. Install the system in accordance with Country, National or to the U.S. National Electric Code if you are in the United States.

Precautions:

1. The building facilities in which the product will be used requires a fuse or circuit breaker no larger than 15A for 120Vac (U.S.A.) or 10A, 230Vac (international). The building facilities must protect the Midspan from over current and short-circuits.
2. Before connecting the Midspan to a power source (including power cord requirements), read the Midspan Hardware Setup procedure in Section 2. This procedure as with all procedures and instructions can be found in the Midspan User Manual. To download a copy of the Manual, visit www.phihong.com or www.midspans.com.
3. To prevent the Midspan from overheating, do not operate the product in an area that exceeds the maximum recommended ambient temperature of 40oC. Allow at least 3 to 4 inches of clearance around all ventilation openings.
4. In order to support the midspan's weight, do not stack the chassis on any other equipment. Shelf mounted equipment requires a stable and durable surface. When installed, do not push or pull on the Midspan when the equipment is installed.
5. The Midspan consists of two rows of "Data" and "Data & Power" ports. The ports use RJ-45 data sockets. Do not connect telephone cables into these ports. Only RJ-45 data cables may be connect to these sockets.
6. Do not work on the Midspan system or connect or disconnect the cables, during periods of lightning activity.
7. The AC plug/socket combination must be accessible at all times, as it serves as the main disconnect device to the product.
8. Before servicing the product, always disconnect the products from its AC and DC source.
9. Disposal of this product should abide by all appropriate National laws and regulations.



1.1 Sicherheitsmaßnahmen – Allgemeine Vorsichtsmaßnahmen

Allgemein – Lesen Sie die folgenden Vorsichtsmaßnahmen sorgfältig durch, bevor Sie das System installieren und an eine Energiequelle anschließen.

Hinweis – Das Gerät darf nur durch qualifiziertes und geschultes technisches Personal (gemäß IEC 60950 [Vorschrift 60950 der Internationalen Elektrischen Kommission] und AS/NZS 3260 [Vorschrift für Australien und Neuseeland]) installiert, ersetzt oder repariert werden. Installieren Sie das System auch in Übereinstimmung mit den geltenden nationalen oder europäischen Vorschriften bzw. Der NEC-Vorschrift, falls Sie sich in den Vereinigten Staaten befinden.

Vorsichtsmaßnahmen:

1. Die Gebäudeinstallationen, in denen das Produkt benutzt wird, müssen über eine Sicherung oder einen Schutzschalter mit maximal 15A für 120 Vac (USA) oder 10A für 230Vac (international) verfügen. Die Gebäudeinstallationen müssen das Midspan-Device vor zu starkem Strom oder Kurzschlüssen schützen.
2. Lesen Sie vor dem Anschließen des Midspan-Device an eine Energiequelle (einschließlich der erforderlichen Anschlussleitungen) die Setup-Anleitung für Ihre Midspan-Hardware in Kapitel 2 genau durch. Dieses Verfahren wird zusammen mit allen weiteren Vorgängen und Anweisungen im Benutzerhandbuch für das Midspan-Device beschrieben. Sie können das Benutzerhandbuch unter www.midspans.com oder www.phihong.com herunterladen.
3. Um das Midspan-Device vor Überhitzung zu schützen, benutzen Sie das Produkt nicht in Räumen, die die maximale empfohlene Umgebungstemperatur von 40°C überschreiten. Lassen Sie um alle Lüftungsöffnungen herum mindestens 7,5 bis 10 cm (3-4 inches) frei.
4. Stützen Sie das Gewicht des PoE Midspan-Device nicht ab, indem Sie das Gehäuse auf ein anderes Gerät stellen. Falls Sie das Gerät auf ein Gestell montieren, muss dieses eine stabile und haltbare Oberfläche haben. Nach der Installation des Systems bewegen Sie das Midspan-Device nicht mehr.
5. Das Midspan-Device enthält zwei Reihen mit "Datenports" und "Daten-und-Stromports." Die Ports verwenden RJ45-Datenanschlüsse. Schließen Sie keine Kabel an und trennen Sie keine Kabelverbindungen während Gewittern mit Blitzen.
6. Führen Sie an dem Midspan-System keine Arbeiten durch, schließen Sie keine Kabel an und trennen Sie keine Kabelverbindungen während Gewittern mit Blitzen.
7. Der Steckanschluss Wechselstrom muss jederzeit zugänglich sein, da er als Haupttrenngerät für das Produkt dient.
8. Trennen Sie das Produkt immer erst von der Stromquelle, bevor Sie Wartungs- oder reparaturarbeiten daran durchführen.
9. Entsorgen Sie dieses Produkt gemäß aller geltenden Gesetze und Vorschriften Ihres Landes und der EU (falls Sie sich in einem Land der EU befinden).

2. Midspan Hardware Setup

2.1 Physical Hardware Appearance:

2.1.1 Single Port Models

Front View:

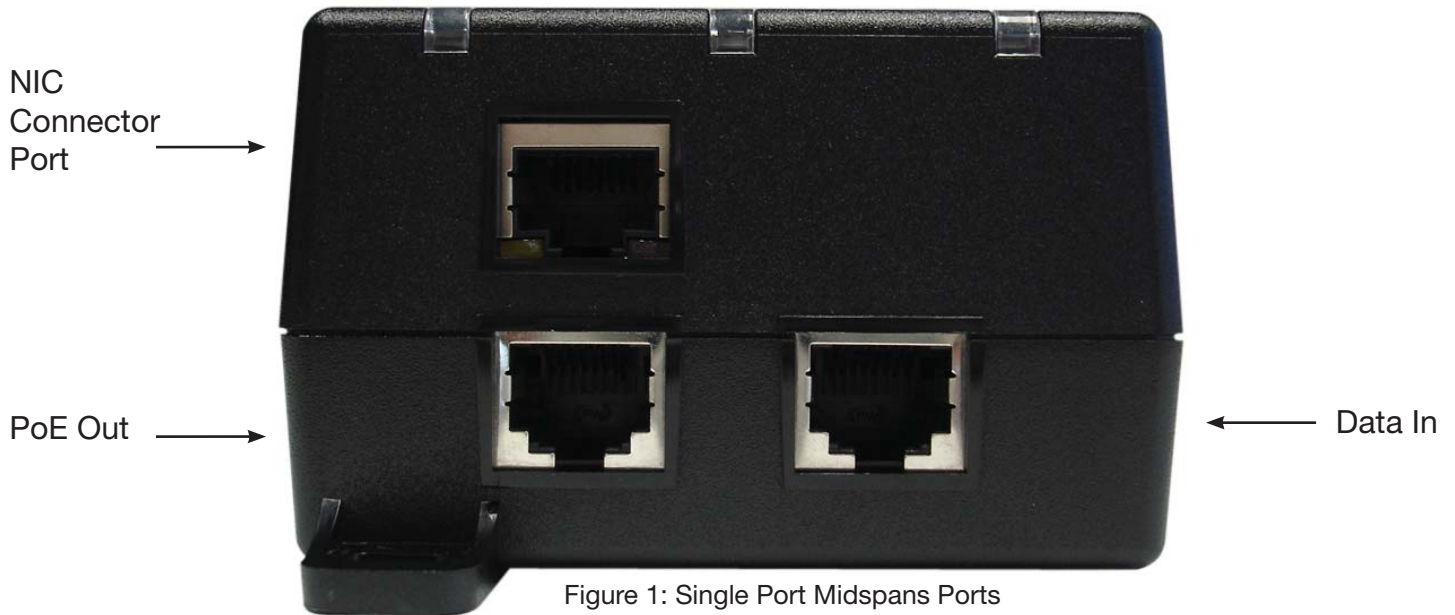

Rear View:



2.1.2 Small Frame Multiport Models

Front View:

Figure 3: Small Frame Multiport Midspan Ports



↑
Row 1: Data and Power OUT
to the Powered Device

↑
NIC Management Port

Row 2: Data IN from the Network
Switch

Rear View:

Figure 4: Small Frame Multiport Midspan AC Input



↑
IEC320 C14 AC Input



2.1.3 1U Multiport Midspans

Front View:

Figure 5: 1U Multiport Midspan Ports



Row 1: Data and Power OUT
to the Powered Device

Row 2: Data IN from the Network
Switch

NIC Management Port

Rear View:

Figure 6: 1U Multiport Midspan AC Input



IEC320 C14 AC Input

2.2 Connecting Ethernet Cables*

2.2.1 Single Port Midspans

NIC Connection:

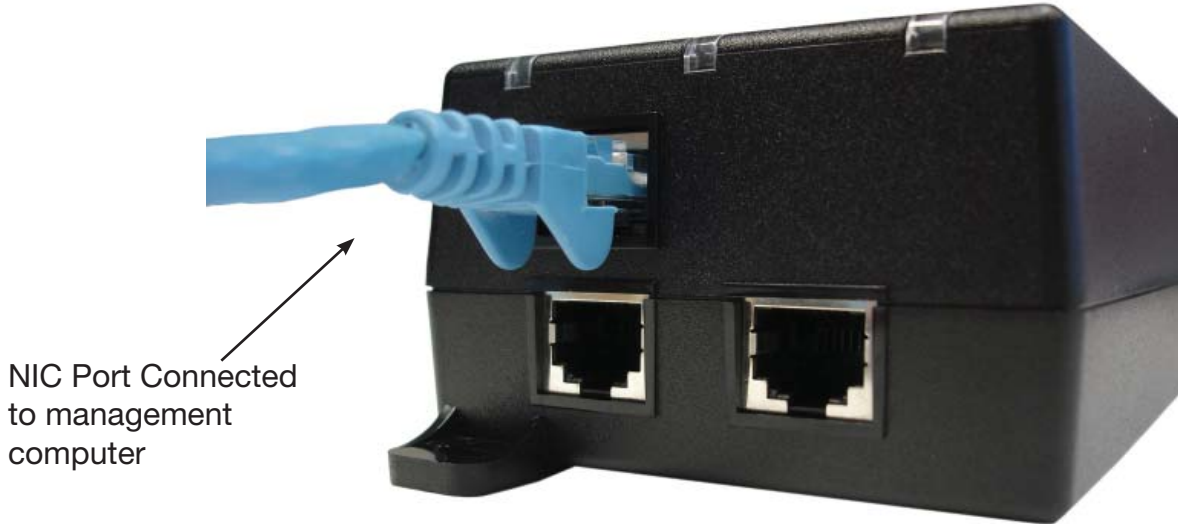
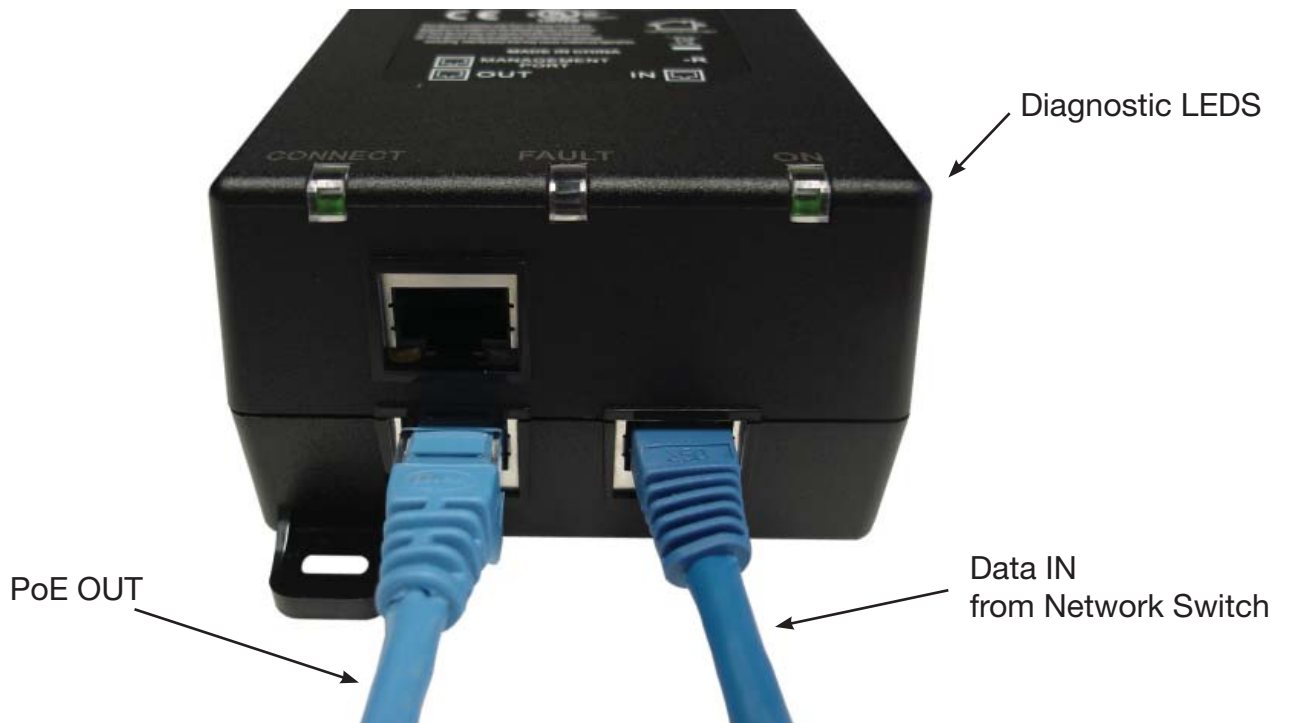

Figure 7: Single Port Midspan SNMP Connection

Ports Connection:

Figure 8: Single Port Midspan PoE and Data Connection



*Ethernet cables are not included

2.2.2 Small Frame Multiport Midspans

NIC Connection:

NIC Port Connected
to management
computer



Figure 9: Small Frame Multiport Midspan SNMP Connection

Ports Connection:

PoE OUT
Connected to a
Valid Load

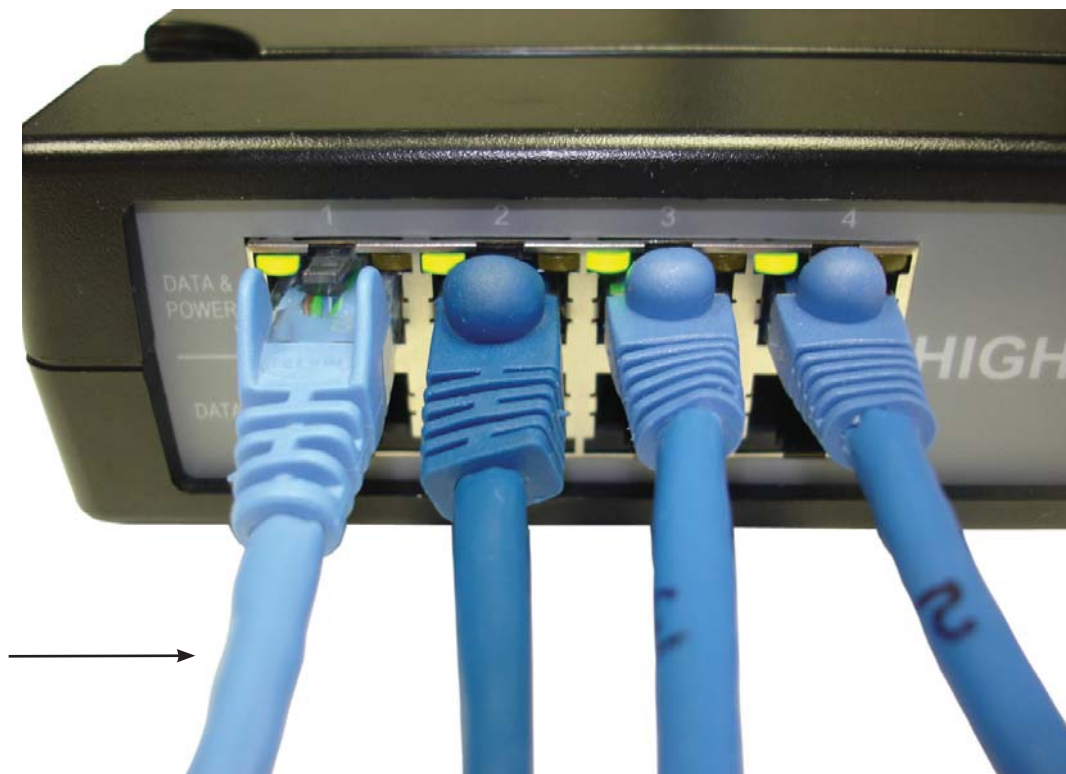

Figure 10: Small Frame Multiport Midspan Data and PoE Connection

2.2.3 1U Multiport Midspans

NIC Connection:

NIC Port Connected
to management
computer



Figure 11: 1U Multiport Midspan SNMP Connection

Ports Connection:

Figure 12: 1U Multiport Midspan Data and PoE Connection

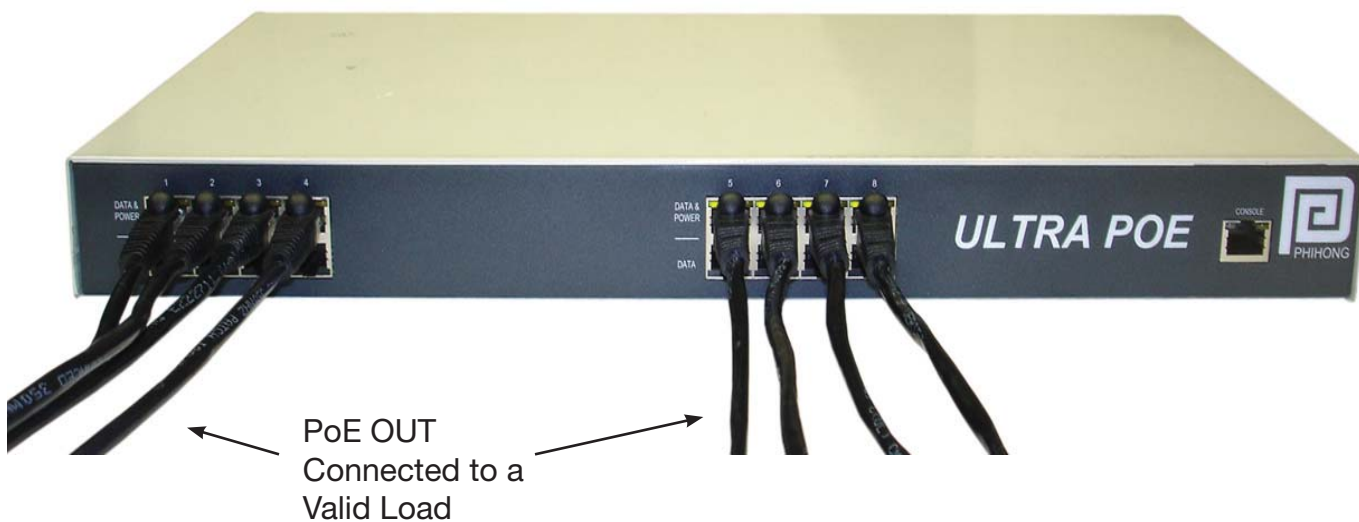

2.3 Midspan Accessories

2.3.1 Rack Mounting Options/AC Power Cord

All multiport midspans may be rack mounted on a 19"1U rack in either single or double unit mounts (Small footprint multiport midspans). To position the Midspan on the rack; arrange the mounting bracket to the corresponding screw holes on the Midspan. Keep the screw area visible to insert screws, and then tighten the screws. Screws and brackets will be included in the package. For replacement parts contact Phihong for part number POE125U-ACCY01-R.



Figure 13: Single Unit Rack Mount



Figure 14: Two Units in Side by Side Rack Mounting



Figure 15: Rack Mounted 19" Midspan

Figure 16: Mounting Bracket



Figure 17: AC Power Cord*



The AC power cable is connected to the AC power connector located in the rear side of the Midspan and the power outlet.

*AC Power Cord may be ordered separately.



2.4 Powering Your Midspan

Power Cord Requirements

Power cords must meet the requirements for the country it is intended to be used.

U.S.A and Canada

- The cord must have a minimum of 10A rated current competence
- The cord must be CSA or UL approved
- The minimum requirement for the flexible cord is:
 - o 18 AWG (10A)
 - o Three-Conductor (Line, Neutral, Ground)
 - o Type SV (stranded Vacuum Rubber Jacketed) or SJ (stranded Junior Rubber Jacketed) or SVT (Stranded Vacuum Rubber Jacketed Thermoplastic) or SJT (Stranded Junior Thermoplastic)
- The plug must be earth-grounded with a NEMA 5-15 (15A, 125V) or NEMA 6-15P (15A, 250V) configuration

Europe

Switzerland

- The supply plug must comply with SEV/ASE 1011

Denmark

- The supply plug must comply with section 108-2-D1, standard DK2-1a or DK2-5a

United Kingdom

- The Midspan is covered by General Approval (section 16.16.060, NS/G/12345/J100003, for indirect connection to a public telecommunication system)

France and Peru

- IT equipments cannot power this device. In the case of an IT powered device, the unit needs to be powered by 230V through an isolation transformer with a ratio of 1:1 and the secondary connection (Neutral) is properly grounded

- The Midspan must have access to a nearby power outlet. By disconnecting the power cord from the outlet, you will eliminate power from the device.
- The flexible cord that connects to the Midspan must have a configuration to connect with an EN60320/IEC320 inlet connector.
- According to the EN60950/IEC 950 specifications this device functions under SELV (Safety Extra Low Voltage) conditions. The conditions are true if the equipment and the connected device functions under SELV conditions.



Power up Midspan:

In order to power up your midspan insert an AC power cord into the appropriate connector on the rear of your midspan. Once the cord is connected to a universal or redundant power source the midspan will turn on.

With AC power applied, the unit starts-up and all LEDs should illuminate. The device runs through a quick power-on test, which takes a couple of seconds. During this period, all ports are initially disabled and the port indicators light up. After completing the cold start, ports will operate under normal conditions and the unit is ready to connect to powered devices.

2.5 LED Indicators:

Port LED:

Model POE75U-1UP-N-R has three LED indicators labeled “ON”, “FAULT”, and “CONNECT”. The “ON” LED will illuminate a solid green to indicate that the AC connection is good and that unit is sufficiently powered. The “CONNECT” LED will illuminate solid green if it detects a device that requires more than 33.6W of power (12.5K-resistance). The “CONNECT” LED will illuminate a blinking green if it detects a device requiring less than 33.6W of power (25K resistance) and will power in IEEE802.3at mode. Should a fault occur with the connections; the yellow Fault LED will blink till the error is resolved. For a full description of the LED diagnostics, please review the individual product datasheet on www.phihong.com or www.midspans.com.

For the series of multiport midspans, for each port the left LED (as viewed from front) will be blinking (green) if 25K-resistance load is detected, meaning that the powered device requires less than 33.6W of power and the midspan has powered in “IEEE802.3at mode”. The LED will illuminate in solid green if the powered device requires more than 33.6W of PoE and the midspan has powered up in Full Power mode. The right LED will blink Yellow if a fault has occurred with the connection. No LEDs will illuminate if the port is not connected.

NIC LED:

If both LEDs are off, it indicates that Midspan is disconnected from the network.

If the green LED is illuminated and the orange LED blinks, it indicates the Midspan is properly connected to the network.



2.6 Technical Specifications

Model Name:

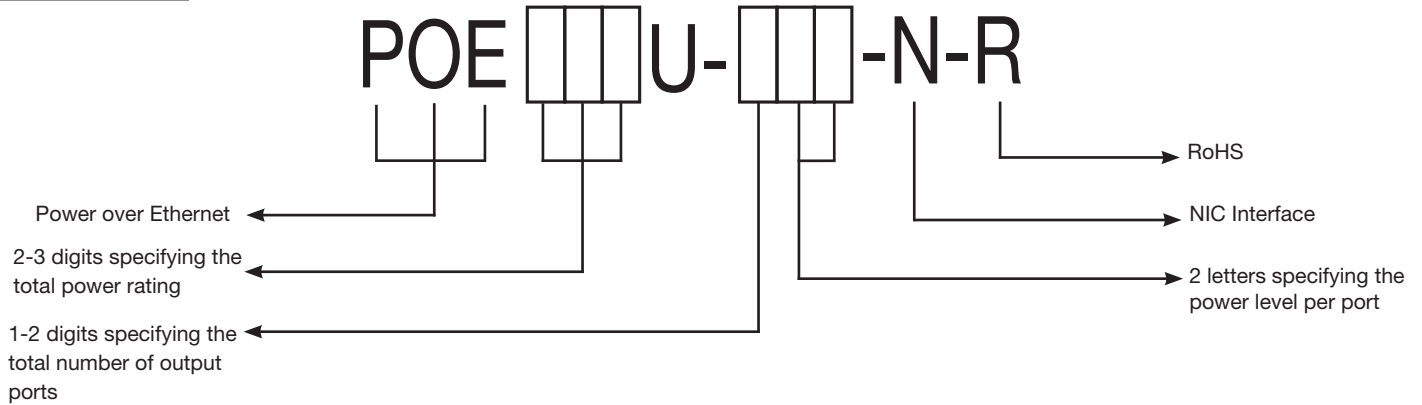

General Electrical Specifications:

- Input

AC Input Voltage Rating	100VAC to 240VAC
AC Input Voltage range	90VAC to 264VAC
AC Input Current	Varies per model
AC Input frequency	47Hz to 63Hz
Max. In-rush current	30A for 115VAC at Max. load 60A for 230VAC at Max. load

- Output

POE125U-4AT-N	POE75U-1UP-N	POE240U-2MP-N	POE240U-4UP-N	POE576U-8UP-N	POE576U-4MP-N	POE806U-8MP-N
Nominal DC Output Voltage						
56V	56V	56V	56V	56V	56V	56V
Output Power per Port						
33.6W	75W	95W	60W	75W	95W	95W
Maximum Current per Port						
0.6A	1.339A	1.696A	1.071A	1.339A	1.696A	1.696A

- Detection Resistance

POE125U-4AT-N	POE75U-1UP-N	POE240U-2MP-N	POE240U-4UP-N	POE576U-8UP-N	POE576U-4MP-N	POE806U-8MP-N
25K	12.5K and 25K (both)					

For detailed specifications, refer to the datasheets posted on www.phihong.com or www.midspans.com

3 Midspan Monitoring and Control - HTTP Protocol

Use Cat5e cables or better to connect both PC and Midspans to the network as follows:

Figure 18: Management Set-up Diagram

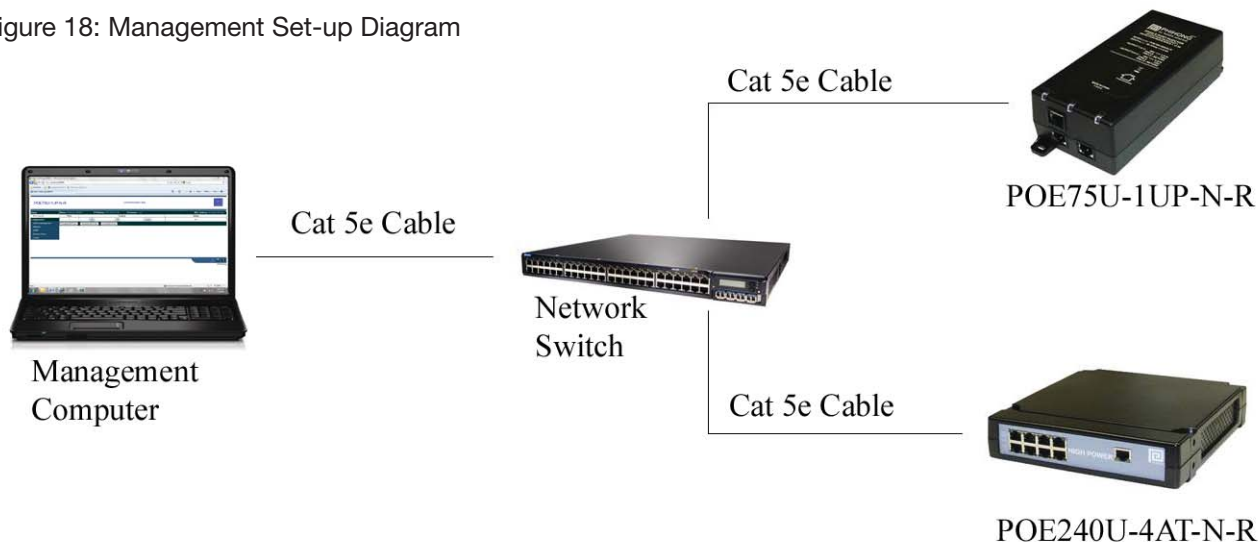

3.1 Port Control Webpage

Enter the hostname in the address bar of your internet browser (The default value of hostname is phihong-xxxxxx, where xxxxxx is the last 6 letters of the Midspan’s MAC address found on the midspan’s label), then enter the username and password in the login screen. The default username and password are both “admin”. Users should note that when creating their new username and password both are case sensitive. The Port Control Webpage will be displayed as follows:

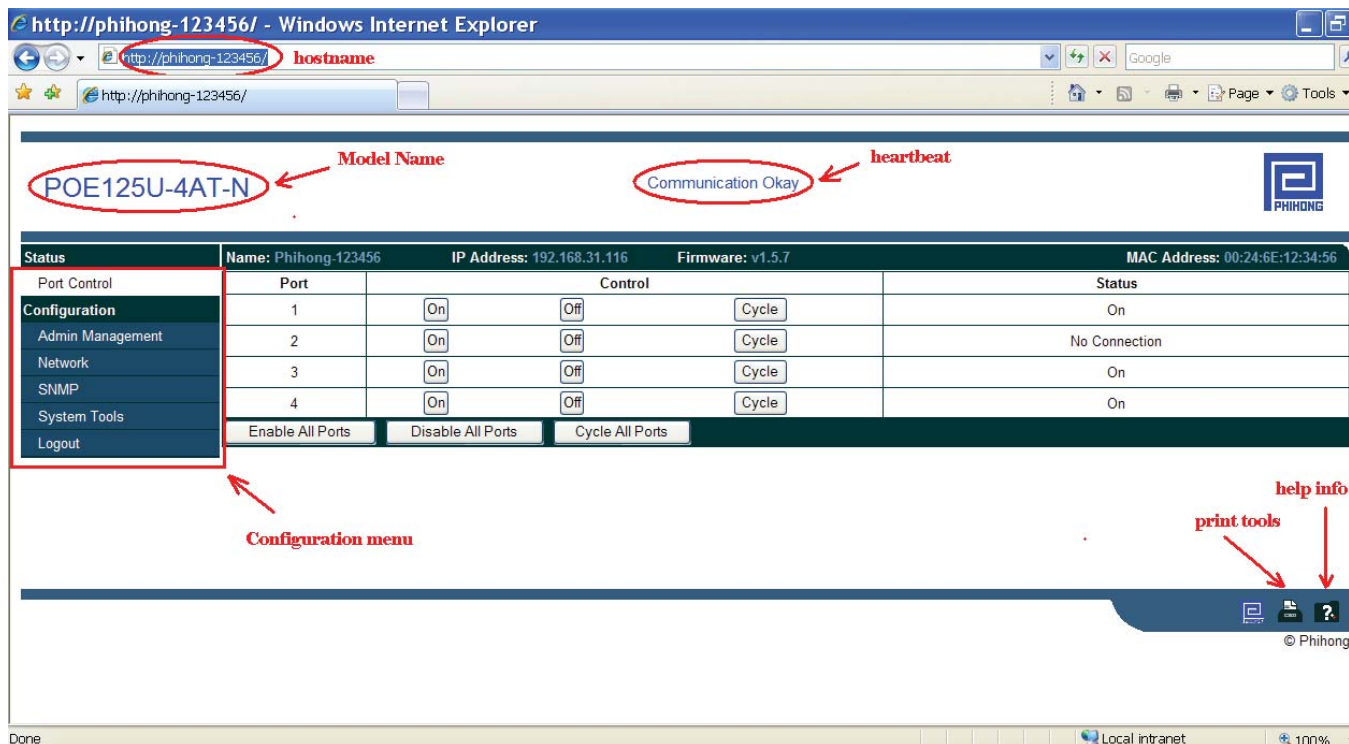

Figure 19: Port Control Webpage



Model Name:

This can be found in the upper left corner of the Port Control page.

Heartbeat:

The Heartbeat is a diagnostic tool to assess the quality of the connection between the midspan and the network. A blinking blue “Communication Okay” will indicate that the midspan is connected to the network and that data is being relayed correctly. Should a fault occur with the connection; the blinking will stop and a solid red “Communication Lost” will appear on the screen.

Hostname, IP address, Firmware version and MAC address display:

These can be found on the first row of the table located in the middle of the Port Control Page.

Menu:

The menu on the left side of webpage consists of Port Control and Configuration Settings including: Administrative Management, Network, SNMP, System Tools and Logout. These will be explained in detail later in this manual.

Help Info:

Located in the lower right hand corner of the screen, users may click the Help Info icon to obtain contact information for technical support. Users may also find support documents and contact information on www.midspans.com and www.phihong.com.

Print Tools:

To the left of the Help Info icon is the Print Tools icon. Clicking on this icon will print the current webpage. The default printer must be on the same network as the midspan in order to use this function.

Phihong webpage:

Clicking on any of the Phihong logos will link directly to www.phihong.com, where the detailed information for all Phihong products, including support information and datasheets, can be found.

Port Monitoring and Control:

At the center of the Port Control webpage, there is a table for the user to monitor and control port status.

- Click on the control button “On” in each row, the corresponding port Output-LED will be turned on if connected to a valid load, or it will display “No Connection”.
- Click on the control button “Off” in each row, the corresponding port Output-LED will be turned off.
- Click on the control button “Cycle” in each row to reset that port, if the corresponding port Output-LED is already on (or No Connection), it will be turned off for several seconds and then turned on again (or No Connection). If the Output-LED is off, it will be turned on (or No Connection).



- Click the button Enable All Ports below the table, the port Output-LEDs will be turned on if connected to a valid device or it will display a status “No Connection” if a port is not connected to a valid end device.
- Click the button Disable All Ports below the table, all port Output-LEDs will be turned off.
- Click the button Cycle All Ports in the last row, all port Output-LEDs will follow one of the following actions: If the ports are already “ON” then the ports will be “On” (or No Connection) » Off » Turning On... » On (or No Connection). If all ports start turned off then the sequence will be Off » Turning On... » On (No Connection), depends on their original states.



3.1 Administrative Management

Clicking Admin Management under the Configuration menu will bring you to the following page. From here the user can choose their own username and password to login to their Pihong Midspan web controller. Enter in the new username and password in the corresponding box and click on the Save button. Remember to write down your new login information in a safe place for reference. If you forget your login information, please review Section 7 – Frequently Asked Questions.

- Both the username and the password must have a character length of 5 – 30 inclusive.
- Valid characters include: 0-9, A-Z, and !@#\$%^&*()-_+~?<>.,

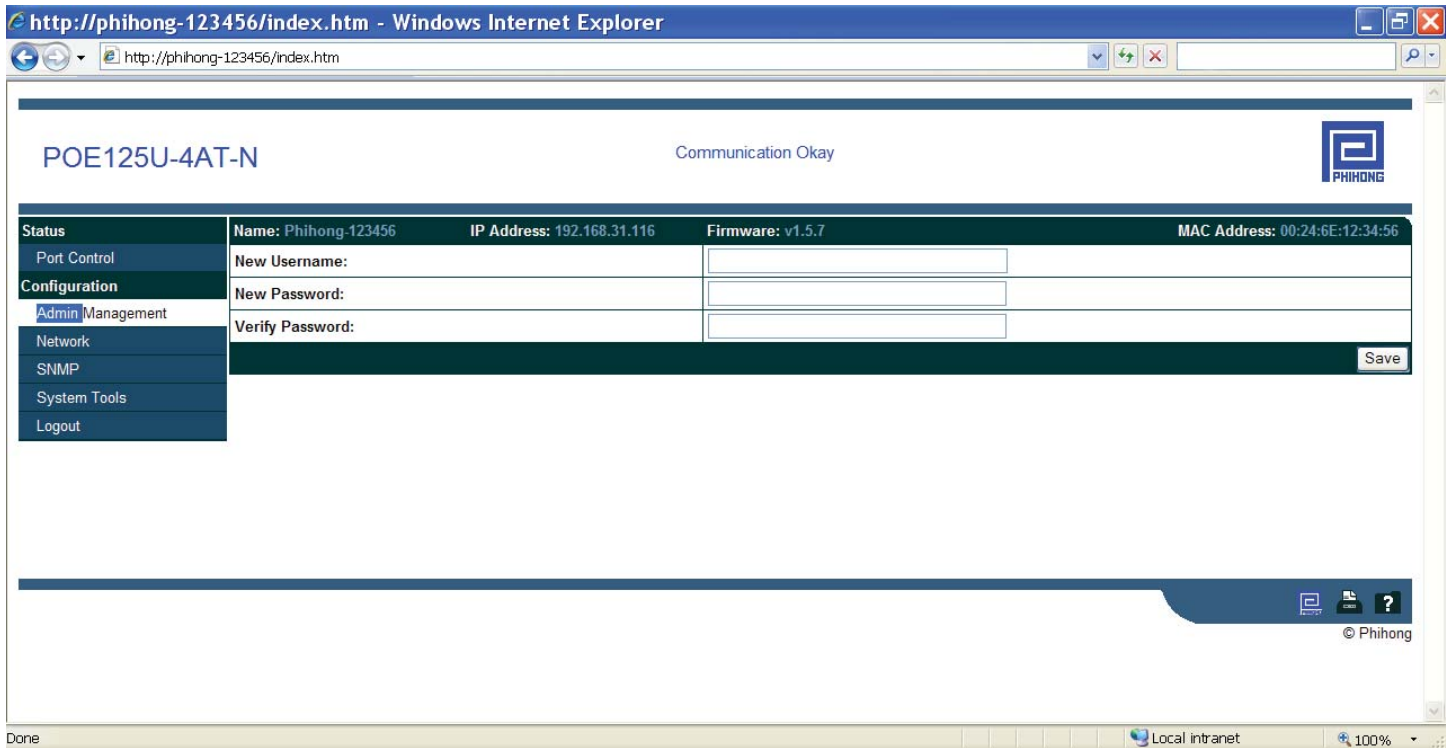

Figure 20: Administrative Management Webpage

3.3 Network Settings

Clicking on the Network button under the Configuration menu will direct to the Network Settings page. This webpage allows the user to change the midspan’s hostname and configure network settings.

Change hostname:

A user may select any character from the keyboard for a hostname up to 15 characters maximum. Any extra characters entered will be truncated. Click on the Save button to save your new hostname or new network settings if they are acceptable, and you will be directed to the Reboot webpage.



Configure network settings:

WARNING: Only the network administrator is allowed to perform this configuration.

Network settings on your midspan can be re-configured. Users can choose DHCP, where the midspan will be automatically assigned an IP address by the network. The alternative option is to choose Static which allowing the user to customize the IP address, IP Subnet Mask, Default Gateway, Primary DNS and Secondary DNS. Users need to be aware that any incorrect settings will cause your midspan to lose a valid network connection or may upset your network's normal operation.

Status	Name: Phihong-123456	IP Address: 192.168.31.116	Firmware: v1.5.7	MAC Address: 00:24:6E:12:34:56
Port Control	Hostname:	<input type="text" value="Phihong-123456"/>		
Configuration	Configuration Server Protocol:	<input checked="" type="radio"/> DHCP <input type="radio"/> Static		
Admin Management	IP Address:	<input type="text" value="192.168.31.116"/>		
Network	IP Subnet Mask:	<input type="text" value="255.255.255.0"/>		
SNMP	Default Gateway:	<input type="text" value="192.168.31.1"/>		
System Tools	Primary DNS:	<input type="text" value="192.168.31.5"/>		
Logout	Secondary DNS:	<input type="text" value="192.168.31.5"/>		
<input type="button" value="Save"/>				

Figure 21: Network Settings Webpage

After clicking the **Save** button, a Reboot page (shown below) will be displayed to inform the user that the Midspan needs to reboot in order to update for the new settings. The Reboot webpage will also display instructions regarding reconnection.



Figure 22: Reboot Webpage

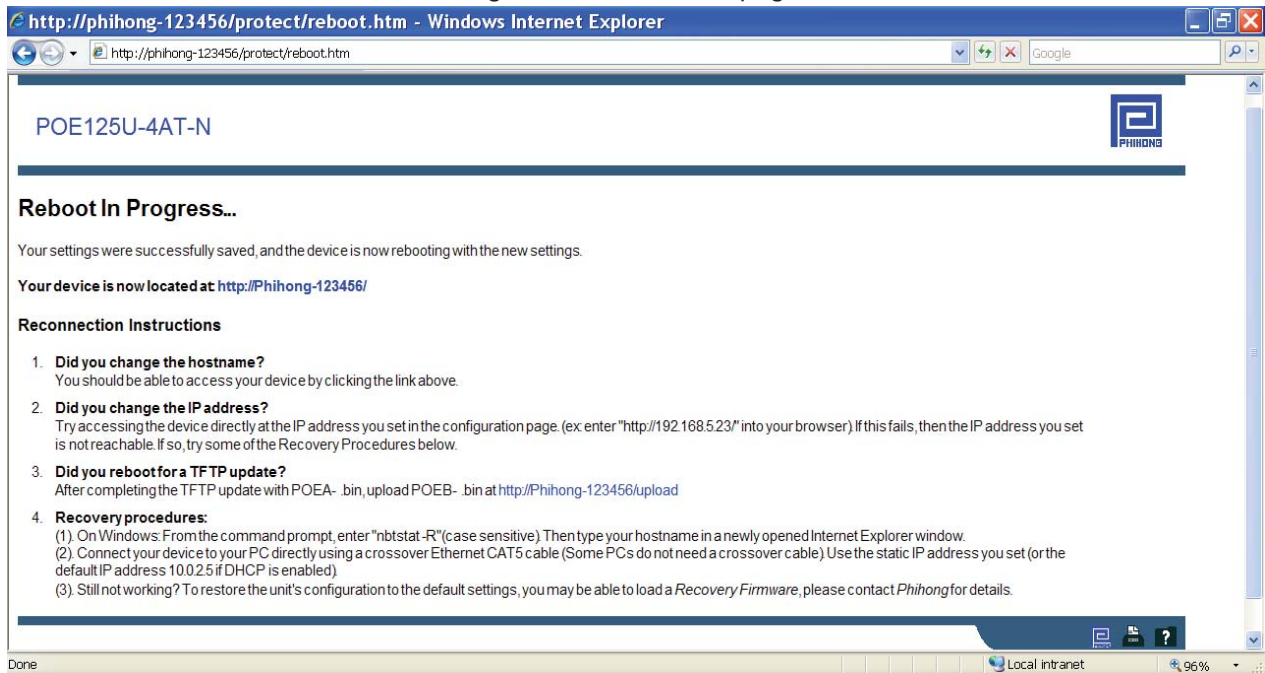

3.4 SNMP Community String

Click **SNMP** under the Configuration menu to be directed to the SNMP Community String settings page. Phihong’s midspans allow users to change the SNMP Read-Only Community String and Read-Write Community String. SNMP community string is a security feature. Only those nodes sharing the same community strings in a network may participate in a communication exchange.

The maximum length of the community string is 30 characters. When the new community string is entered, click the Save button to allow the midspan to reboot for the new settings.

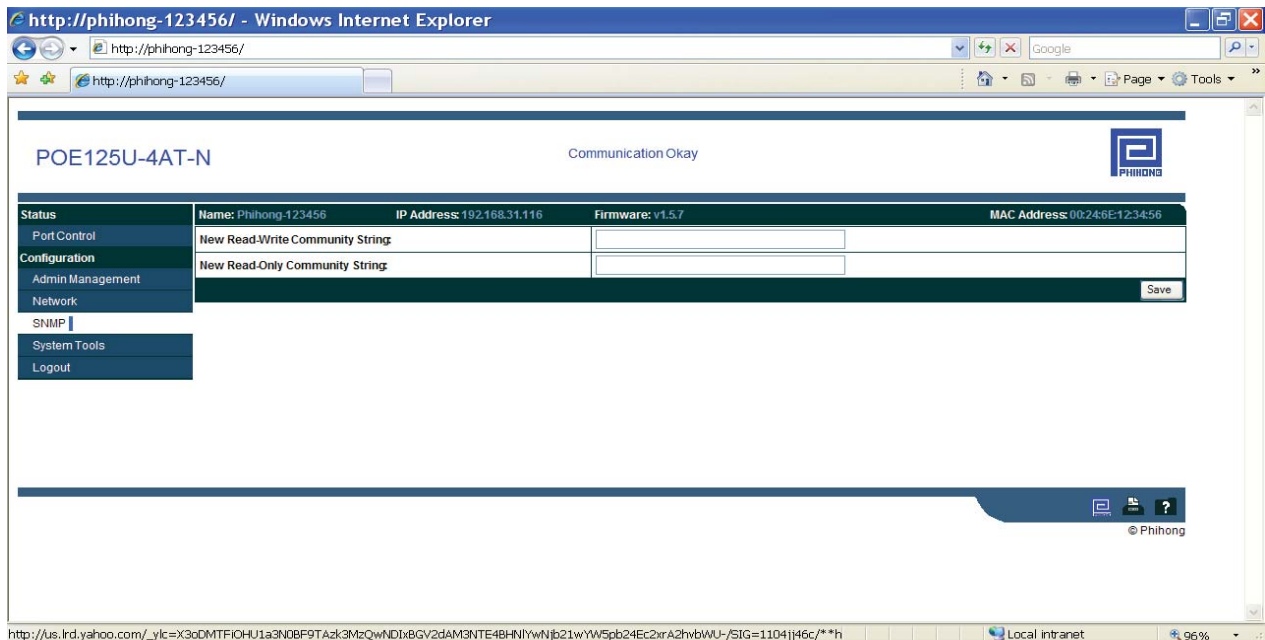

Figure 23: SNMP Community String



3.5 System Tools

This System Tools webpage allows user to execute the following 3 tasks:

1. Upload Firmware

Upload the binary file POEB-x.x.x.bin (web/SNMP image) into the midspan's internal EEPROM directly. Note that if a new version of firmware is released, in order to update, you first must use the Windows TFTP command to upload POEA-x.x.x.bin into the midspan's internal microprocessor, then upload POEB-x.x.x.bin. Please review Chapter 5: Firmware Updating at Field for more details regarding TFTP uploading.

To upload web/SNMP image, using the Browser button to locate file POEB-x.x.x.bin, then click on the Upload button. If the upload is successful, a new page will display the message <Software Update Successful>. Click on the link referencing the site main page to be redirected to the newly updated controller.

2. Reboot Midspan.

In addition to the Reboot button, there is an input-box for time associated with the Reboot button. The Seconds input-box specifies the time for the boot loader to wait for a TFTP firmware upload after a power reset. Read Chapter 5: Firmware Updating at Field for more details regarding a TFTP upload.

Choose 0 seconds for a normal reboot. If you have uploaded the POEA-x.x.x.bin via TFTP boot load, then a value of at least 6 must be input prior to clicking the Reboot button, then the page will be redirected to the Reboot webpage. Note that the POE ports will be turned off while the boot loader is waiting for an upload, however, if a reboot of 0 seconds (fast reset) is selected, the power across the ports in use will not experience any interruption.

3. Restore Defaults.

The Restore Defaults button restores midspan to the factory defaults, and redirects the user to the Rebooting page.

Review the following default settings for your Phihong midspan.

hostname: phihong-xxxxxx where 'xxxxxx' is the last 6 characters of the midspan's MAC address.

user name: admin (case sensitive)

password: admin (case sensitive)

DHCP: enabled

read-write community: Phihong

read-only community: Phihong-read-only



Figure 24: System Tools Webpage

http://phihong-123456/ - Windows Internet Explorer

http://phihong-123456/

POE125U-4AT-N

Communication Okay

PHIHONG

Status	Name: Phihong-123456	IP Address: 192.168.31.116	Firmware: v1.5.7	MAC Address: 00:24:6E:12:34:56
Port Control	Software Upgrade:		<input type="text"/> Browse...	Upload
Configuration	Reboot:		Reboot	and listen for <input type="text"/> seconds for a TFTP update
Admin Management	Restore Factory Defaults:		Restore Defaults	
Network	Note: Use POEB-* for "Software Upgrade", and use POEA-* for "TFTP update". Do "TFTP update" first.			
SNMP				
System Tools				
Logout				

© Phihong

Local intranet 100%

4. Midspan Monitoring and Control through MIB Browser --- SNMP Protocol

Simple Network Management Protocol (SNMP) is used most commonly in network management systems to monitor network-attached devices for remote diagnostics. Users can monitor and control Phihong midspans using the SNMPv2c protocol. There are many SNMP consoles available, with very little difference between them; Phihong leaves the final choice to user preference. Users may obtain all the SNMP MIB information shown in this manual in a txt file found in the support sections of our websites: www.midspans.com and www.phihong.com.

4.1 Structure of Management Information (SMI) for Phihong Midspans

Figure 25: Phihong Midspan SMI

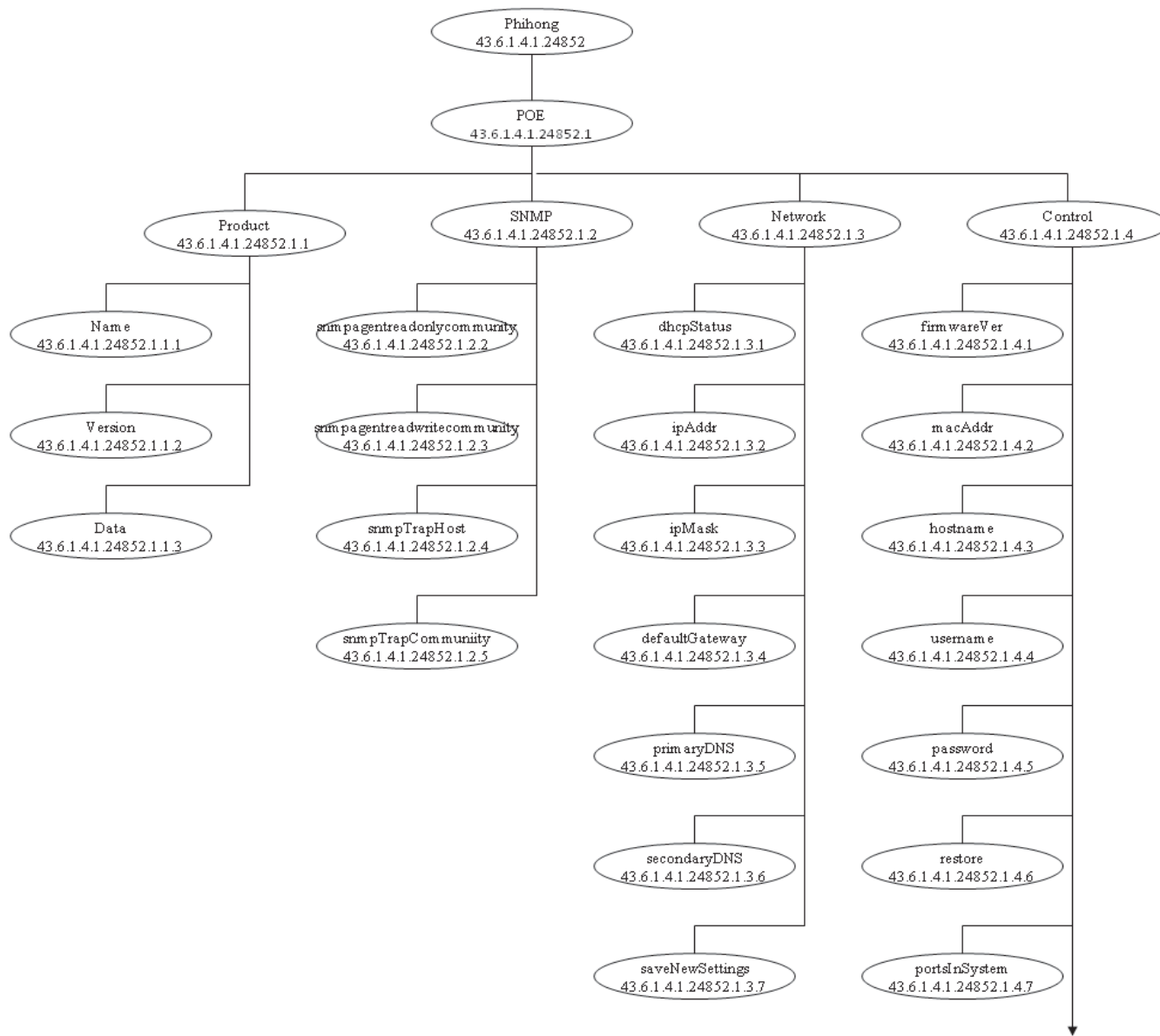

More on the Next Page



Figure 26: Phihong Midspan SMI Continued

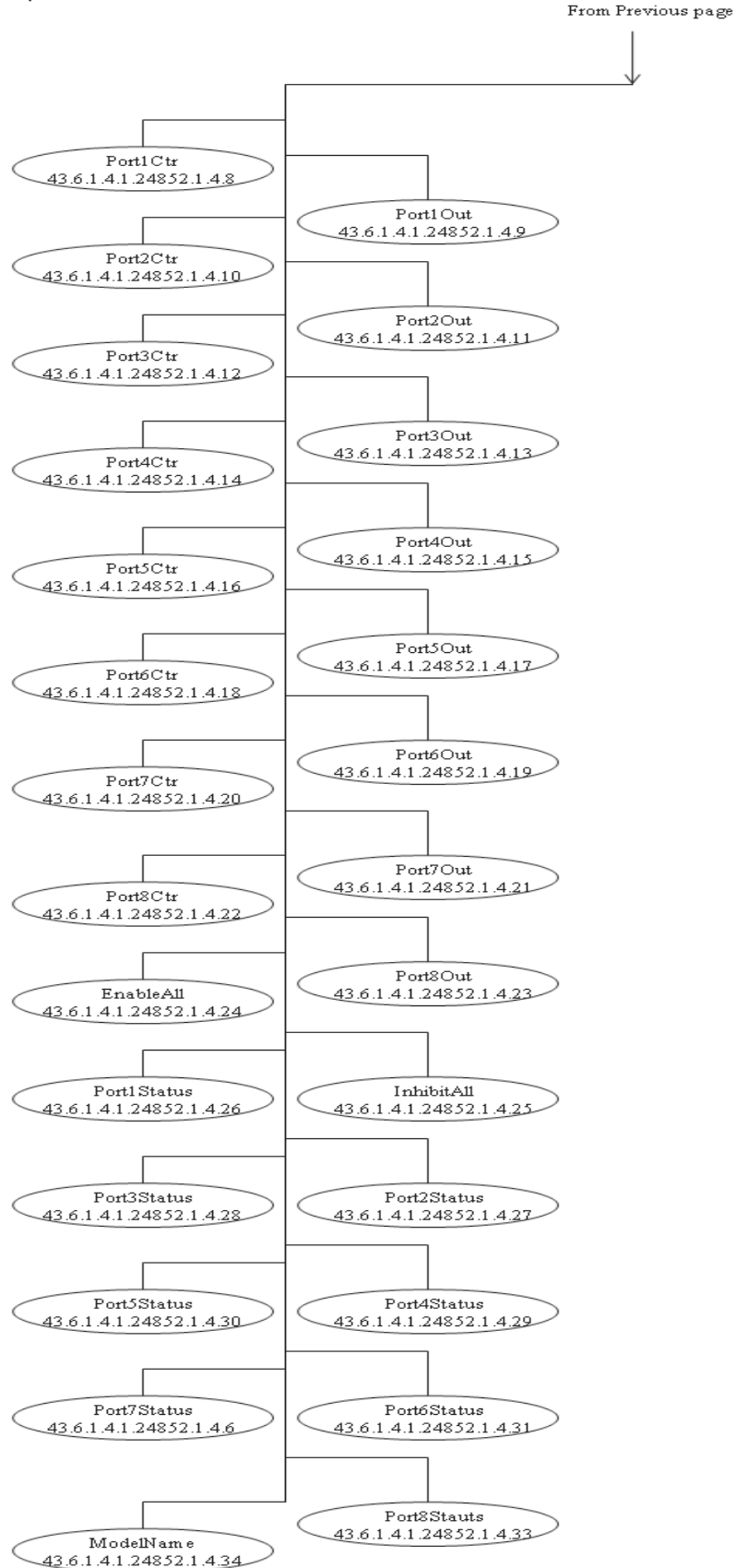



4.2 Phihong Midspan MIB

The following table shows the OID, Name, Type, Value, and Description of Phihong Midspan MIB.

Phihong USA Corp. registered PEN (Private Enterprise Number) is 1.3.6.1.4.1.24852

SNMP Version: SNMPv2c (Simple Network Management Protocol Version 2 Community-based) TCP, UDP Port: 161.

OID	Name	Type	Value	Description
phihong.poe.product (1.3.6.1.4.1.24852.1)				
1.3.6.1.4.1.24852.1.1.1	name	Read-Only	DisplayString	Display the name of this MID (Phihong SNMP MIB)
1.3.6.1.4.1.24852.1.1.2	version	Read-Only	DisplayString	Display the current Phihong Midspan firmware version
1.3.6.1.4.1.24852.1.1.3	date	Read-Only	DisplayString	Display the date when the current MIB updated
phihong.poe.snmp (1.3.6.1.4.1.24852.1.2)				
1.3.6.1.4.1.24852.1.2.2	snmpAgentReadOnlyCommunity	Read-Write	DisplayString	SNMP community string tor Read
1.3.6.1.4.1.24852.1.2.3	snmpAgentReadWriteCommunity	Read-Write	DisplayString	SNMP community string for Write
1.3.6.1.4.1.24853.1.2.4	snmpTrapHost	Read-Write	DisplayString	The IP of Host to receive Trap
1.3.6.1.4.1.24852.1.2.5	snmpTrapcommunity	Read-Write	DisplayString	SNMP Community string for trap



phihong.poe.network (1.3.6.1.4.1.24852.1.3)				
1.3.6.1.4.1.24852.1.3.1	dhcp	Read-Write	enable(1); disable(0)	Enable or disable DHCP
1.3.6.1.4.1.24852.1.3.2	inAddr	Read-Write	IpAddress	Read or set static IP
1.3.6.1.4.1.24852.1.3.3	ipMask	Read-Write	IpAddress	Read or change IP Mask
1.3.6.1.4.1.24852.1.3.4	defaultGateway	Read-Write	IpAddress	Read or change Default Gateway
1.3.6.1.4.1.24852.1.3.5	primaryDNS	Read-Write	IpAddress	Read or change Pri- mary DNS
1.3.6.1.4.1.24852.1.3.6	secondaryDNS	Read-Write	IpAddress	Read or change Second DNS
1.3.6.1.4.1.24852.1.3.7	saveNewSettings	Write-Only	Integer (0 -- 25)	(1). Reboot device and vaildate the new settings. (2). Specify the waiting seconds (0 - 255) for TFTP.
phihong.poe.control (1.3.6.1.4.1.24852.1.4)				
1.3.6.1.4.1.24852.1.4.1	firmwareVer	Read-Only	DisplayString	Display current firmware version
1.3.6.1.4.1.24852.1.4.2	macAddr	Read-Only	DisplayString	Display unit's MAC address
1.3.6.1.4.1.24852.1.4.3	hostname	Read-Write	DisplayString	Read or change the hostname



1.3.6.1.4.1.24852.1.4.4	username	Read-Write	DisplayString	Read or change the username for web
1.3.6.1.4.1.24852.1.4.5	password	Read-Write	DisplayString	Read or change password for web
1.3.6.1.4.1.24852.1.4.6	restore	Write-only	restoreDefaults(1)	Restore factory default settings
1.3.6.1.4.1.24852.1.4.7	portsInSystem	Read-Only	Integer (1 --8)	Display the port number in device
1.3.6.1.4.1.24852.1.4.8	Port1Ctr	Read-Write	on(1); off(0); na(63);	Port1 control: ON; OFF; N/A
1.3.6.1.4.1.24852.1.4.9	Port1Out	Read-Only		Port1 output: ON; OFF; N/A
1.3.6.1.4.1.24852.1.4.10	Port2Ctr	Read-Write		Port2 control: ON; OFF; N/A
1.3.6.1.4.1.24852.1.4.11	Port2Out	Read-Only		Port2 output: ON; OFF; N/A
1.3.6.1.4.1.24852.1.4.12	Port3Ctr	Read-Write		Port3 control: ON; OFF; N/A
1.3.6.1.4.1.24852.1.4.13	Port3Out	Read-Only		Port3 output: ON; OFF; N/A
1.3.6.1.4.1.24852.1.4.14	Port4Ctr	Read-Write		Port4 control: ON; OFF; N/A
1.3.6.1.4.1.24852.1.4.15	Port4Out	Read-Only		Port4 output: ON; OFF; N/A
1.3.6.1.4.1.24852.1.4.16	Port5Ctr	Read-Write		Port5 control: ON; OFF; N/A



1.3.6.1.4.1.24852.1.4.17	Port5Out	Read-Only		Port5 output: ON; OFF; N/A
1.3.6.1.4.1.24852.1.4.18	Port6Ctr	Read-Write		Port6 control: ON; OFF; N/A
1.3.6.1.4.1.24852.1.4.19	Port6Out	Read-Only		Port6 output: ON; OFF; N/A
1.3.6.1.4.1.24852.1.4.20	Port7Ctr	Read-Write		Port7 control: ON; OFF; N/A
1.3.6.1.4.1.24852.1.4.21	Port7Out	Read-Only		Port7 output: ON; OFF; N/A
1.3.6.1.4.1.24852.1.4.22	Port8Ctr	Read-Write		Port8 control: ON; OFF; N/A
1.3.6.1.4.1.24852.1.4.23	Port8Out	Read-Only		Port8 output: ON; OFF; N/A
1.3.6.1.4.1.24852.1.4.24	enableAll	Write-Only	enable(1)	Enable all ports in device
1.3.6.1.4.1.24852.1.4.25	inhibitAll	Write-Only	inhibit(0)	Inhibit all ports in device
1.3.6.1.4.1.24852.1.4.26	port1Status	Read-Only	on(0); notConnected(1); fault(2); off(3); na(63);	Display Port1 status
1.3.6.1.4.1.24852.1.4.27	port2Status	Read-Only		Display Port2 status
1.3.6.1.4.1.24852.1.4.28	port3Status	Read-Only		Display Port3 status
1.3.6.1.4.1.24852.1.4.29	port4Status	Read-Only		Display Port4 status
1.3.6.1.4.1.24852.1.4.30	port5Status	Read-Only		Display Port5 status
1.3.6.1.4.1.24852.1.4.31	port6Status	Read-Only		Display Port6 status
1.3.6.1.4.1.24852.1.4.32	port7Status	Read-Only		Display Port7 status



1.3.6.1.4.1.24852.1.4.33	port8status	Read-Only		Display port8 status
1.3.6.1.4.1.24852.1.4.34	modelName	Read-Only	DisplayString	Display device's Model Name

4.3 Notes for using Phihong Midspan MIB

1. Although Phihong midspans using SNMPv2c protocol can also run under a SNMPv1 console with the same MIB file, they will not operate with Phihong's SNMPv3 MIB, as the MIB files are not the same.
2. There is a tree node <network> in Phihong Midspan devices, which allows the network administrator to change the settings of dhcpStatus, ipAddr, ipmask, defaultGateway, primaryDNS and secondaryDNS. If these settings are changed; the OID <saveNewSettings> must be set at a value of "0" to reboot the device and validate the new settings. For other events requiring a system reboot, users can also set a value of '0' to <saveNetSettings>, except for a TFTP upload (refer to Chapter 5: Firmware updating at field). A TFTP upload requires a value greater than or equal to '6' to validate the upload.
3. Although <hostname> should technically be listed under network, we place it into the <control> section as it does not need a second step (rebooting) to be validated. <macAddr> which is read-only and follows the same rebooting rule, is also in this section.



4.4 Using MG-SOFT MIB Browser to run Phihong Midspan

As an example, we have detailed instructions on how to operate a Phihong Midspan using the MG-SOFT MIB browser. These instructions do not apply to all MIB browsers, please see instructions for your specific browser if you don't want to use this software.

4.4.1 Generate Phihong-POE-MIB module

It is assumed that MG-Soft MIB browser is already installed on your PC. For detailed operation information, users can get help by choosing from the menu **Help » User Manual** when the MG-SOFT MIB Browser is opened.

1. Open the MIB Browser and click the **Continue** button on the **Welcome** popup window. A **Tip of the Day** window may pop-up for certain options in this browser. Users may choose to click the little box in the lower left hand corner to stop these pop-ups.
2. Click the **MIB** tab; remove any MIB modules in the "Loaded MIB modules" by highlighting and double clicking them.
3. Under the Action menu - open **Run MIB Compiler**.
4. In the MG-SOFT MIB Compiler window, click **File** then **Compile.....** then in the **Open** window, browse for and open PHIHONG-POE-MIB.txt (users can get **SNMP MIB rev 10/30/09** from the support section on either www.phihong.com or www.midspans.com).
5. If compiling is successful, a **Compiled MIB Modules** window will be displayed. Click **Save All** and click **OK** on the **Browse for Folder** window.
6. Close the **MG-SOFT MIB Compiler** window.
7. In the **MG-SOFT MIB Browser** window, click the circular arrow button (the middle one of 5 buttons right below the **Loaded MIB modules** window). This will update the MIB Browser windows' contents (including the newly compiled MIB module Phihong-POE-MIB).
8. In the lower window, click the tab **MIB Modules**. Locate the module < Phihong-POE-MIB >. Highlighting and double clicking it will load it into the upper **Loaded MIB modules** window.
9. Also locate <RFC1213-MIB> and <SNMPv2-MIB>, load them into the upper **Loaded MIB modules** window.
10. Now the setup for Phihong's Midspan SNMP interface is complete.



Figure 27: Phihong Midspan SMI Continued

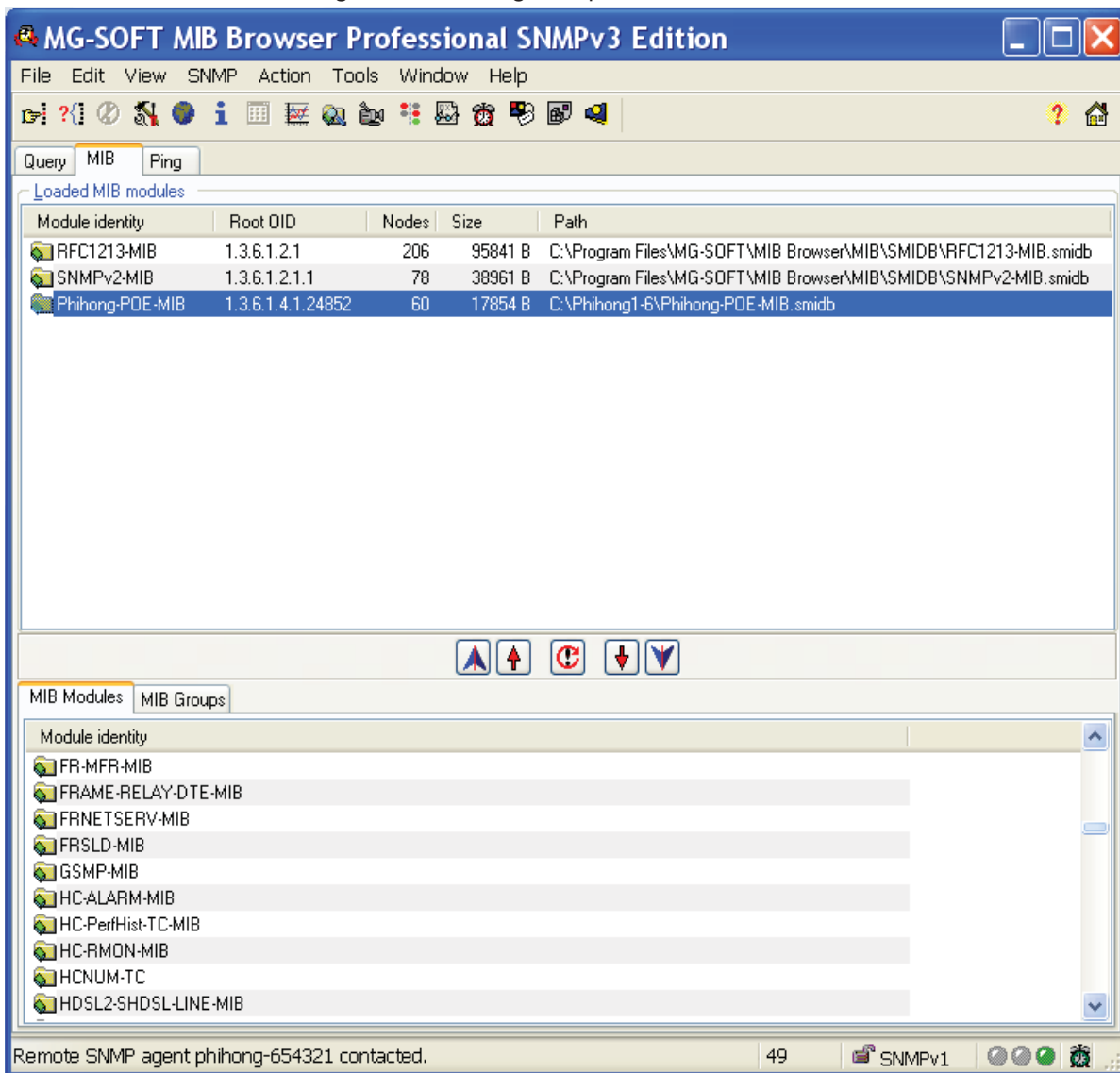

4.4.2 Contact Remote SNMP Agent

1. In the MG-SOFT MIB Browser window, select the **Query** tab. Enter the agent's hostname or IP address into **Remote SNMP agent** box.
2. Click the hammer-symbol icon next to the **Remote SNMP agent** box; ensure all settings are as follows: **SNMPv2c** selected; **phihong_read_only** is entered in the **Read community** box, **phihong** is entered in the **Set community** box or your own custom community strings; **Port Number: 161**.

Figure 28: Set SNMP Protocol to contact remote SNMP agent

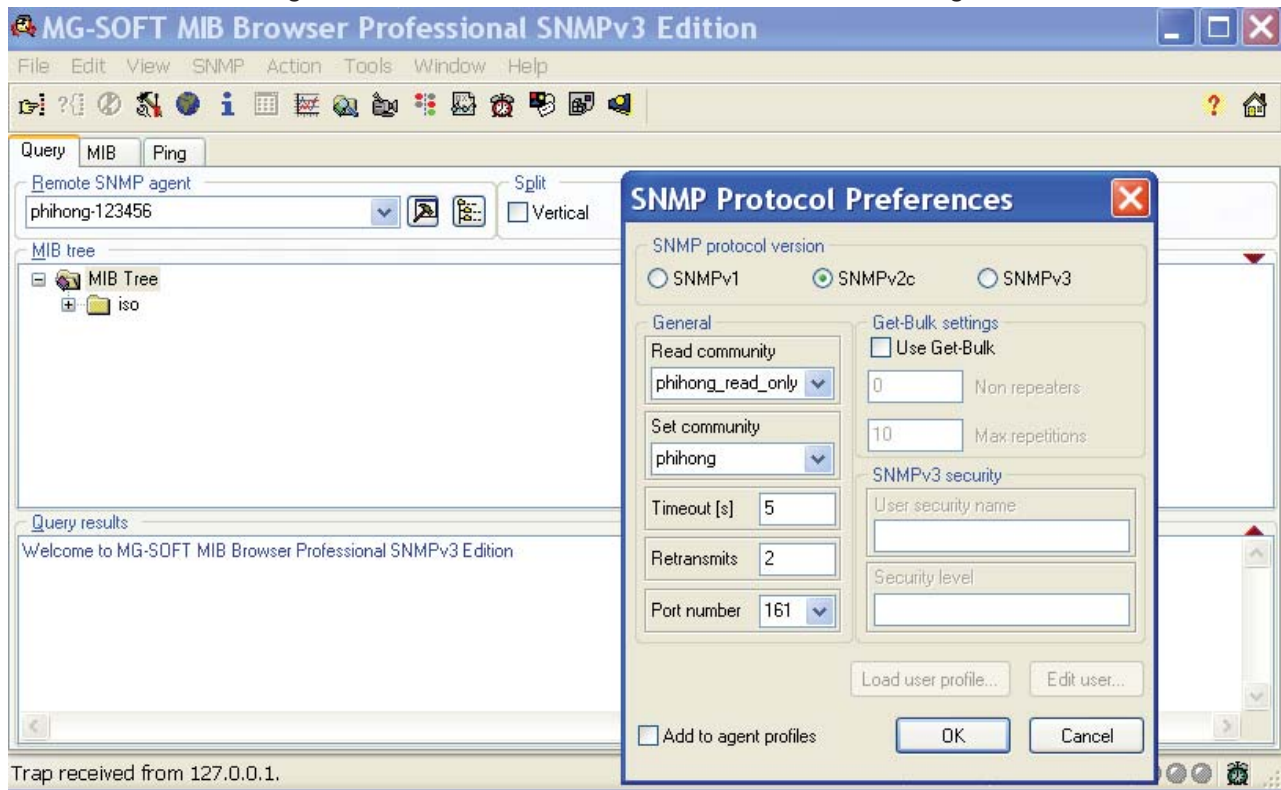

3. Click on the **SNMP** menu then **Contact**. If contact is successful, in the lower **Query Results** window, it will display a message similar to this:

Welcome to MG-SOFT MIB Browser Professional SNMPv3 Edition

Remote address: phihong-123456 port: 161 transport: IP/UDP
 Local address: 192.168.31.124 port: 1301 transport: IP/UDP
 Protocol version: **SNMPv2c**
 1: sysUpTime.0 (TimeTicks) 0 days 02h:28m:06s.59th (888659)

4.4.3 Test for Pihong Midspan SNMP Agent

1. Expand the MIB menu as shown below and locate the <Pihong> node, then continue to expand to the 4 sub-nodes: product, snmp, network and control as shown in Fig. 28.

Figure 29: Pihong Midspan MIB Tree

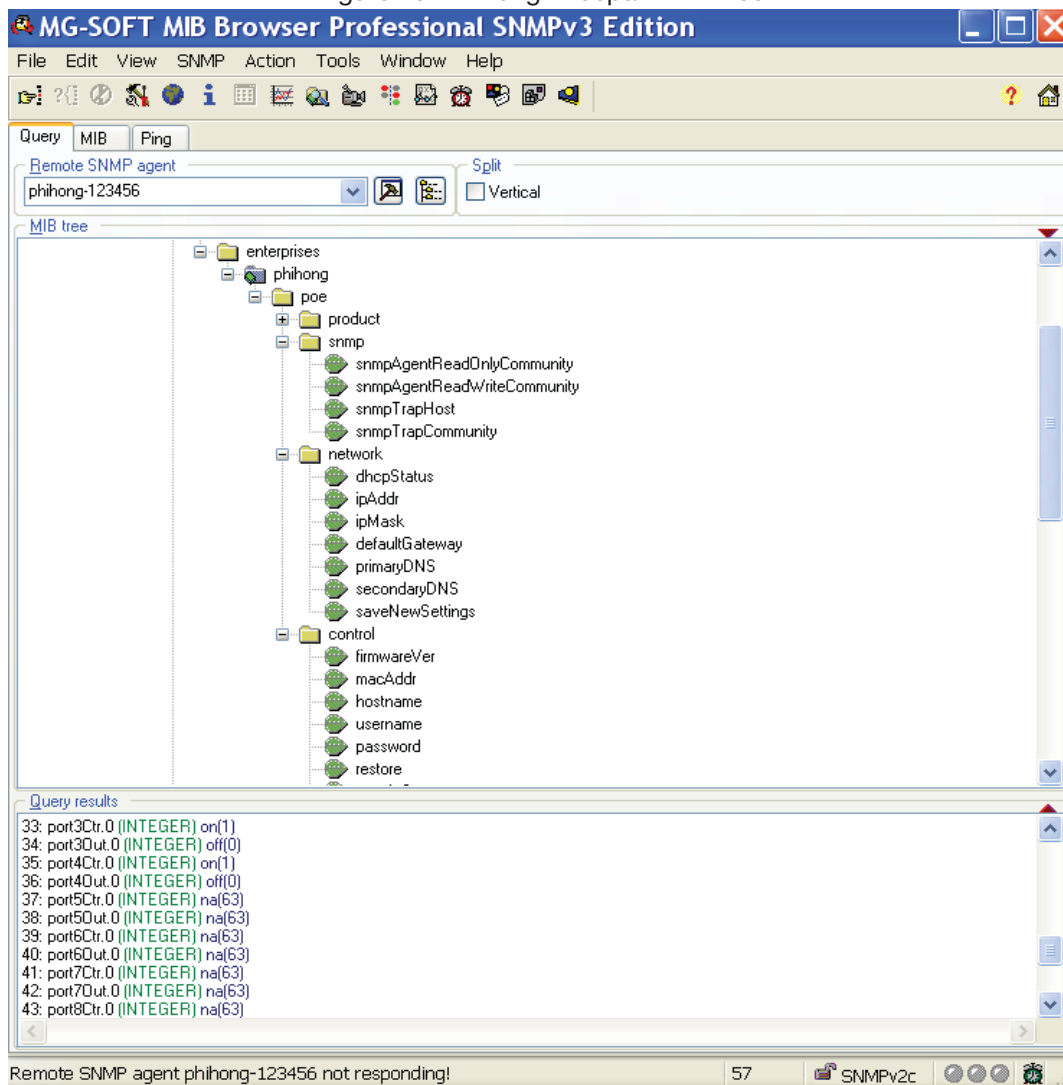

2. Highlight the <pihong> node and click the **SNMP** menu then **Walk**. It will display all readable Control values.
3. To edit a value for writeable Controls: **hostname**, **username**, **password**, **restore**, **portxCtr**, **enableAll**, and **inhibitAll**; highlight the individual control, then use **Set** under the **SNMP** menu to give each control a value. Please refer to Pihong’s Midspan MIB table for the list of assigned values. After entering the control value, click on the “Set Value” icon in the upper left-hand corner (Set –xxxxxx.0 window) to validate the WRITE.



4. To read individual Control values, highlight the individual control, then click **Get** under the SNMP menu to read values from the highlighted control.

5. Change network setting:

WARNING: Only network administrator is allowed to alter this configuration.

Network settings on the Pihong midspan can also be re-configured using your MIB Browser. Users can enable DHCP to allow the network to assign an IP for the midspan automatically, or disable DHCP and configure ipAddr, ipMask, defaultGateway, primaryDNS and secondaryDNS. Remember entering <saveNewSettings> is required to fix the new settings. Incorrect settings may cause your midspan to lose its network connection or crash your network's normal operation.

6. Trap operation (POE port status change notifications)

SETUP:

- a. Expand the MIB Tree to: iso/org/dod/internet/private/enterprises/pihong/poe/snmp.
- b. Highlight <snmpTrapHost>, click **Set** under the **SNMP** menu. Entering your PC's IP address in xxx.xxx.xx.x format. (You can get your PC's IP address by entering <ipconfig> in the Command Prompt window). Click the icon in the upper left hand corner in the **Set - snmpTrapHost.0** window to save the settings.

Figure 30: Set IP Address of Trap Receiver

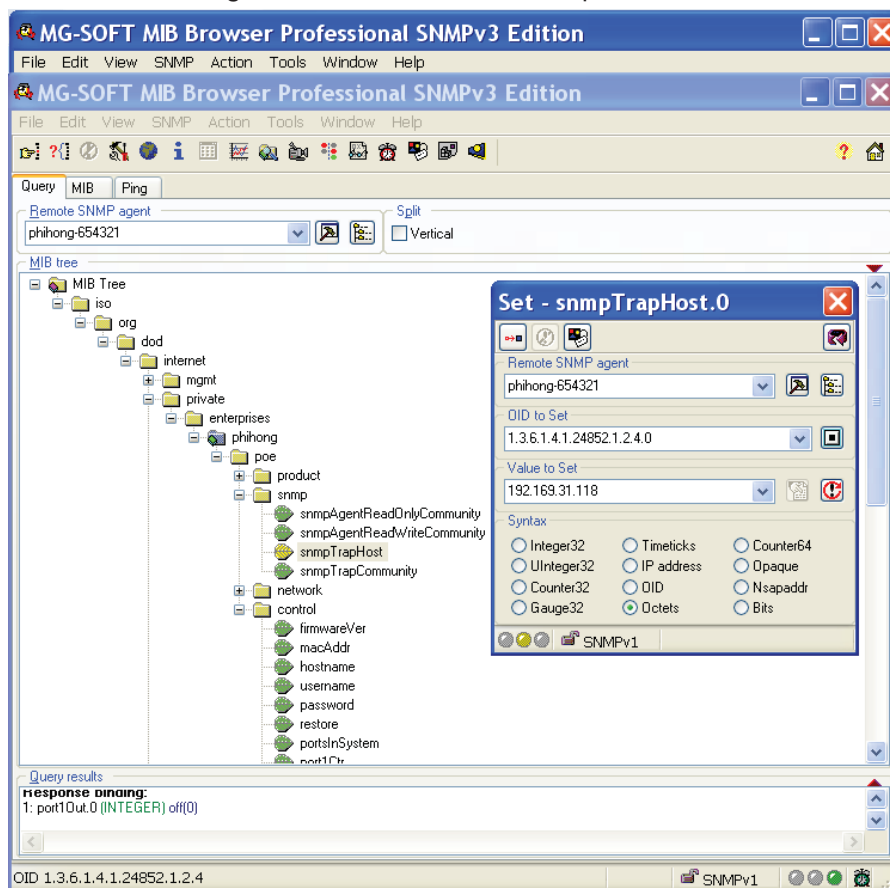

Operation:

Notifications occur whenever a port status is changed.

Connecting or disconnecting a powered device while the unit is “ON”, or turning portxCtr ON or OFF will cause a SNMP Trap Ringer Console window to pop up displaying the change. Click an individual trap event on the left side of the window, the detailed trap info will display on the right. Checking the Pause checkbox will stop trap reporting and un-checking it resume trap reporting. To clear the Trap Ringer Console, click the second icon from the left.

Notes:

If the TRAP receiver IP address is properly set but no notifications are received, a probable cause is that the Windows Firewall is blocking the TRAP UDP Port 162. To open this TRAP port, execute:

Start » Control Panel » Windows Firewall » then select <Exceptions>. If the Firewall is ON, click <Add Port...> button, check radio button <UDP>, enter a Name (for example: SNMP TRAP) and set the port number as 162.

Also check any other firewall on your network that might be blocking the network traffic on UDP Port 162.

Figure 31: Trap Ringer Console (Notification)

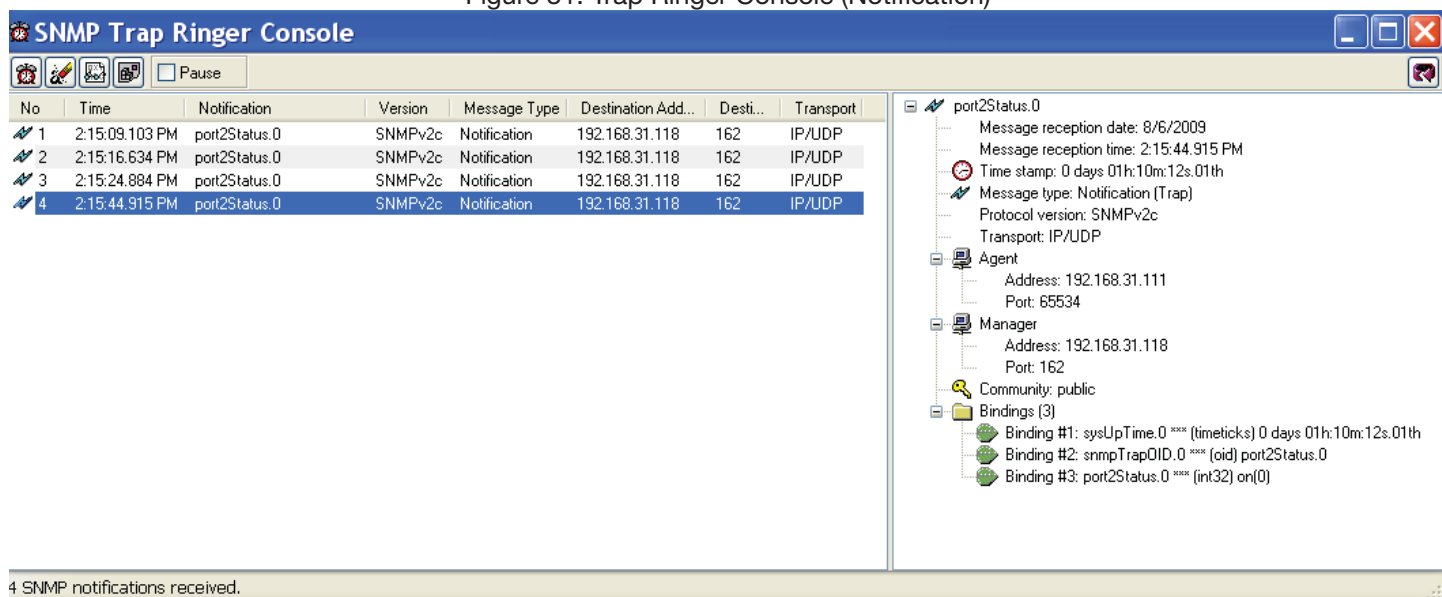

The screenshot shows the 'SNMP Trap Ringer Console' window. It features a toolbar with icons for refresh, edit, print, and a 'Pause' checkbox. Below the toolbar is a table of notifications:

No	Time	Notification	Version	Message Type	Destination Add...	Desti...	Transport
1	2:15:09.103 PM	port2Status.0	SNMPv2c	Notification	192.168.31.118	162	IP/UDP
2	2:15:16.634 PM	port2Status.0	SNMPv2c	Notification	192.168.31.118	162	IP/UDP
3	2:15:24.884 PM	port2Status.0	SNMPv2c	Notification	192.168.31.118	162	IP/UDP
4	2:15:44.915 PM	port2Status.0	SNMPv2c	Notification	192.168.31.118	162	IP/UDP

On the right side, a detailed view of the selected notification (port2Status.0) is shown:

- Message reception date: 8/6/2009
- Message reception time: 2:15:44.915 PM
- Time stamp: 0 days 01h:10m:12s.01th
- Message type: Notification (Trap)
- Protocol version: SNMPv2c
- Transport: IP/UDP
- Agent:
 - Address: 192.168.31.111
 - Port: 65534
- Manager:
 - Address: 192.168.31.118
 - Port: 162
- Community: public
- Bindings (3):
 - Binding #1: sysUpTime.0 **** (timeticks) 0 days 01h:10m:12s.01th
 - Binding #2: snmpTrapOID.0 **** (oid) port2Status.0
 - Binding #3: port2Status.0 **** (int32) on(0)

At the bottom of the window, a status bar indicates: 4 SNMP notifications received.



5. Field Firmware Updating

Phihong is continuously updating our firmware to improve our systems. To ensure that you have the most up-to-date firmware, please check with the support section of our websites: www.phihong.com or www.midspans.com. Updates can be made from the user's PC by installing two essential pieces of software: POEA-x.x.bin and POEB-x.x.bin where x.x is the version number of the firmware. POEA-x.x.bin is the main firmware to be loaded into internal microprocessor, while POEB-x.x.bin needs to be loaded into internal EEPROM.

Update POEA-x.x.bin before updating POEB-x.x.bin.

The MIB is a pure SNMP interface and used to generate the Phihong-POE-MIB.smidb module. To update the Phihong-POE-MIB.smidb module, refer to your SNMP console User Manual (See chapter <4.4.1 Generate Phihong-POE-MIB module> to review this method using the MG-SOFT MIB Browser). Some updating may only need 1 or 2 steps, based on any new firmware requirements as they become available.

5.1. Updating Microprocessor Flash Contents with POEA-x.x.bin

The boot loader inside the Midspan is used to upload POEA-x.x.bin into the internal microprocessor under Windows' TFTP command. Windows XP always includes the TFTP utility. However, on Windows Vista the TFTP utility must be added by setting **Control Panel » Programs and Features » Turn windows features on or off » TFTP client**.

There are two "modes" in which the boot loader can listen for a TFTP firmware upload.

TFTP uploading (Application Entry Mode)

For normal network/internet/SNMP operations, users may use this Application Entry Mode to manage TFTP uploading.

1. Power up the ready-to-upgrade POE unit and connect it to the Ethernet network. Make sure that its TCP/IP feature is functioning. The boot loader will use its TFTP, ARP and ICMP services.
2. Open the Command Prompt Console by clicking Start » Programs » Accessories » Command Prompt.
3. In the Command Prompt Console, type:
Tftp:phihong-xxxxxx put "C: \.....\POEA-x.x.bin" as shown in the **Fig. 5-1**, make appropriate Hostname/IP Address and file path changes, do not execute the TFTP command yet.
4. Because the boot loader always listens for 6 seconds after power-on for a TFTP firmware upload, an appropriate waiting time must be set for after a reboot. Open web » System Tools and in the same screen, enter a value greater than or equal to 6, in the box on the right of the **Reboot** button (or Open SNMPnetwork/, click on the OID <saveNewSettings>, set a value ≥6).



Figure 32:TFTP Uploading using Application Entry Mode

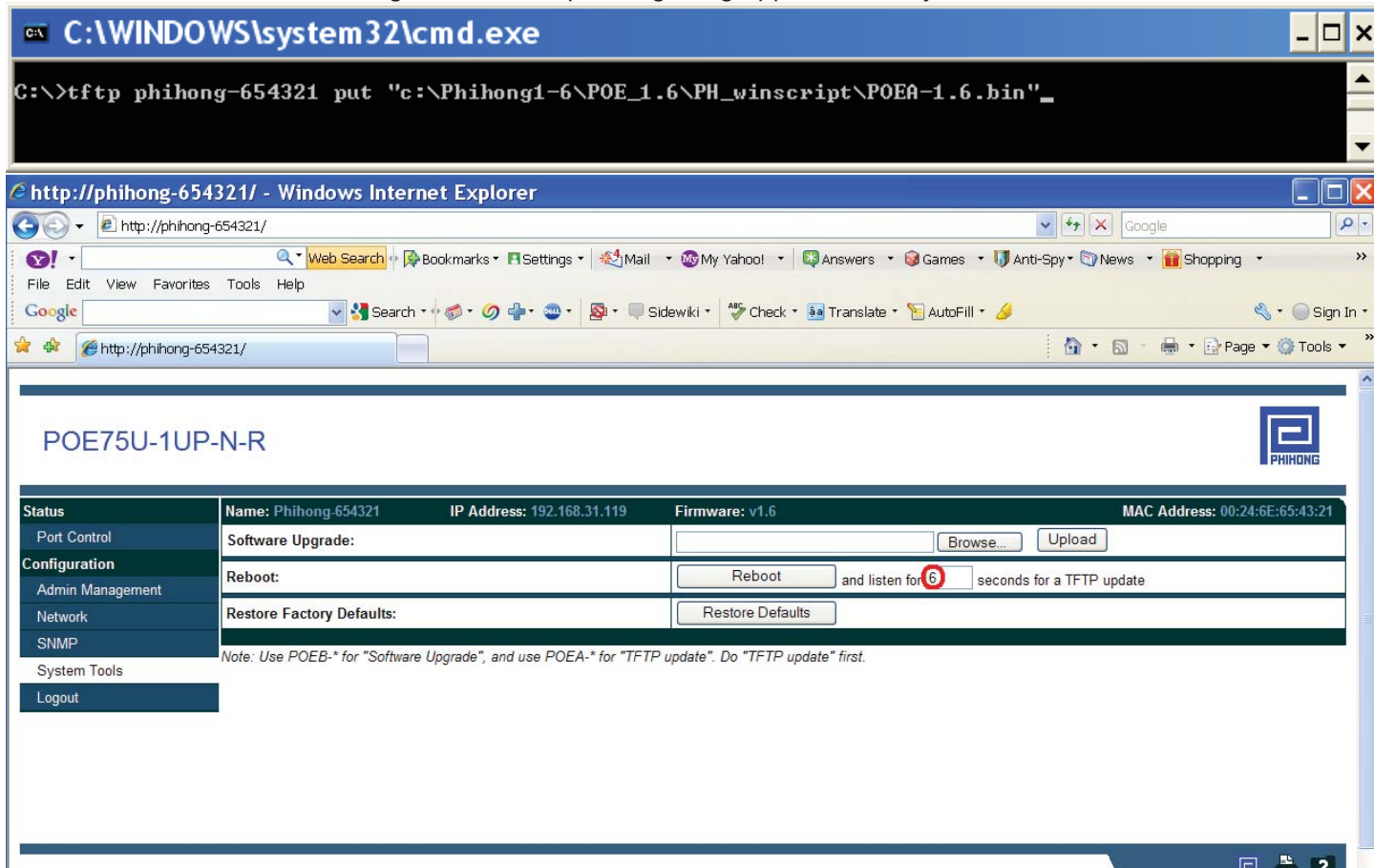

5. Reboot the midspan by clicking the **Reboot** button in the web controller (or clicking the first icon on the upper left hand corner in Set – xxxxxx.0 window to validate the Set value for the SNMP interface). Then quickly switch to the Command Prompt Console to execute TFTP.
6. If successful, the TFTP client will indicate how long the transfer took as well as the transfer rate.
7. After a successful write, the boot loader will quit after a few seconds and the POE unit will start to execute the new application that was just loaded.

If the boot loading process is interrupted due to a network failure or user cancellation, the boot loading may be resumed by simply retrying the TFTP command, provided the power is not cycled. However, if the boot loading operation is interrupted due to power failure, the boot loading must be recovered using the following **TFTP Power-On Reset Entry Mode**.

TFTP uploading (Power-On Reset Entry Mode)

If a valid main firmware is not loaded or a power failure occurred during TFTP uploading Application Entry Mode, then the TFTP uploading Power-On Reset Entry Mode must be used. In this mode, the Midspan device must use a default IP address 10.0.2.5 with a Subnet mask of 255.255.255.0 for a TFTP upload. The procedure is as follows:

1. Configure the PC as a Static Mode by setting **Start » Settings » Network Connections » Local Area Connection » Properties » Internet Protocol (TCP/IP)**. In the Internet Protocol (TCP/IP) Properties window, set a static IP as shown in Fig. 32.

Figure 33: Set static IP in Internet Protocol (TCP/IP) Properties window

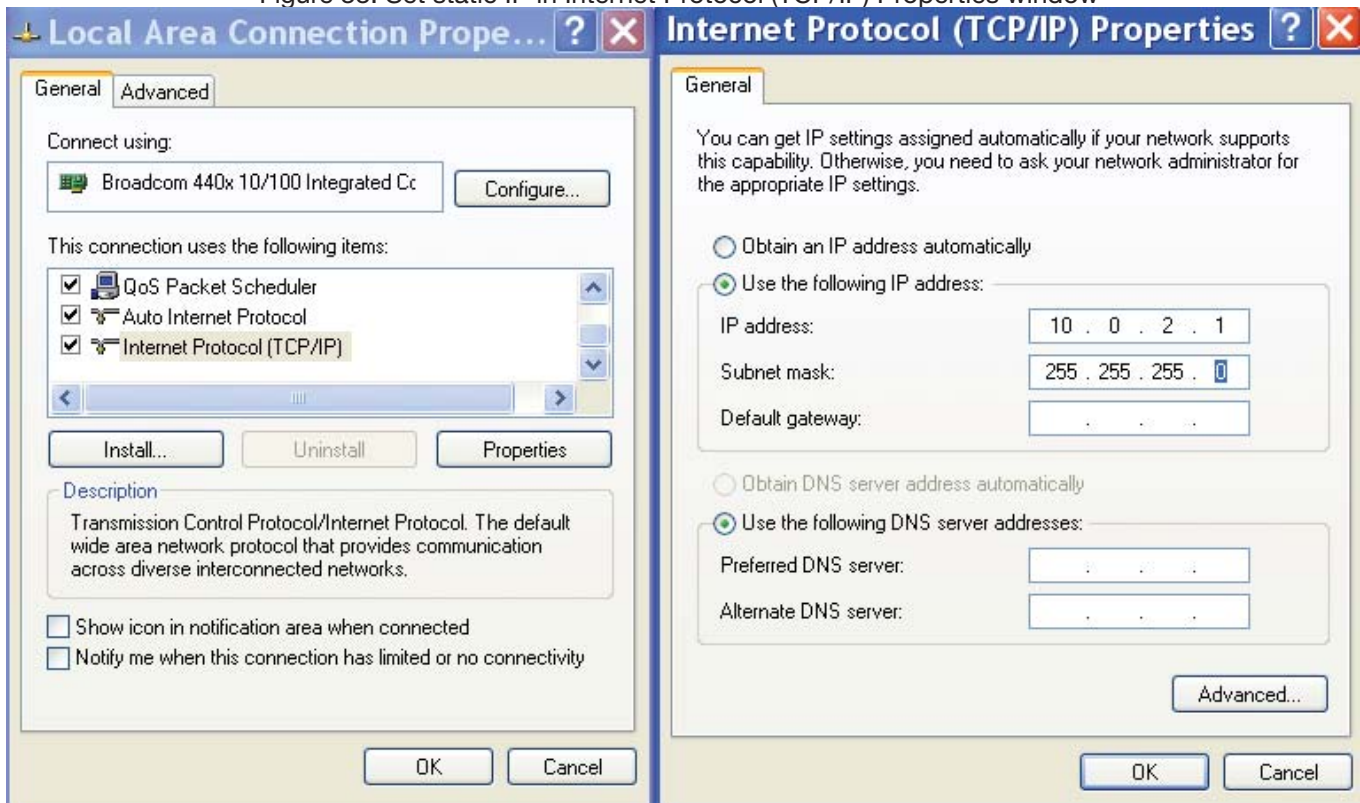

2. Connect the midspan directly to the PC with a Cat5e cable (An older PC may need a crossover Cat5 cable.)
3. In the Command Prompt Console, type the following command but do not execute it:
tftp 10.0.2.5 put "C: \.....\POEA-x.x.bin" , make all the appropriate file path changes.
4. Power up the midspan. If the device is already powered, turn it off by unplugging it for several seconds, and then reconnect it to a power source.
5. Once the green LED on management RJ45 port blinks 3 times, quickly press **Enter** to run the TFTP command. It must be executed at the right moment as soon as the power turns on.
6. After a successful TFTP boot loading process, restore your PC's **Internet Protocol (TCP/IP)** settings to **<Obtain an IP address automatically>** and **< Obtain DNS server address automatically >** to allow normal network activity.

5.2. Updating EEPROM Contents with POEB-x.x.bin

After the POEA-x.x.bin update is complete, the web/SNMP interface image POEB-x.x.bin needs to be uploaded into the internal EEPROM. There are two methods to updating the POEB-x.x.bin.

Method One:

In the address bar of your internet browser, enter `http://hostname/upload`, where hostname is the string corresponding to the Midspan IP address. Then use the **Browse...** button (see Fig.5.3 Upload in Internet Explorer) to locate the file POEB-x.x.bin, then click the **Upload** button.

Figure 34: Upload in Internet Explorer

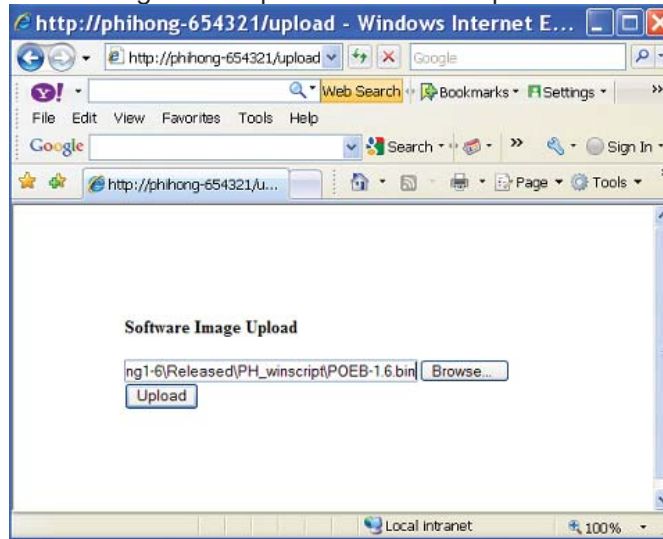

If the EEPROM is successfully updated, <Software Update Successful > will be displayed in a new window. Click on **Site main page** to open the main controller.

Figure 35: Software Update Successful Window

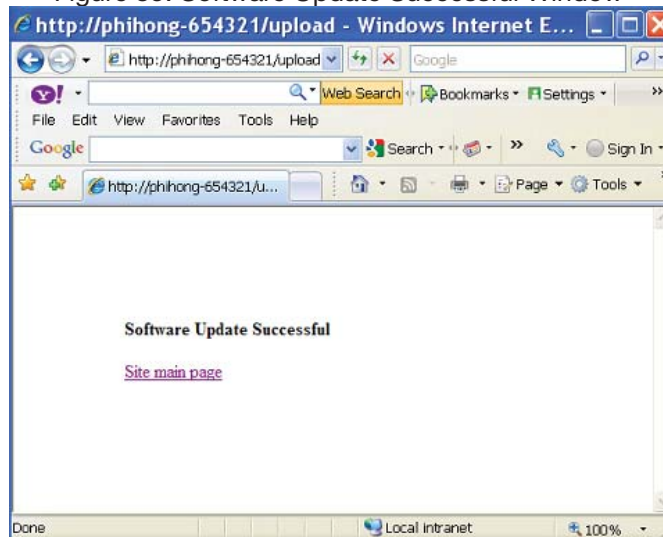



Method Two:

User can also use the Software Upgrade function in the main controller. Select Browser... and locate the file then click the **Upload** button on web/System Tools to update EEPROM.

Figure 36: Upload Using System Tools on Web Interface

The screenshot shows a Windows Internet Explorer browser window displaying the web interface for a Phihong device. The browser address bar shows `http://phihong-654321/`. The page title is `POE75U-1UP-N-R` and the status is `Communication Okay`. The interface includes a navigation menu on the left with items: `Port Control`, `Configuration`, `Admin Management`, `Network`, `SNMP`, `System Tools`, and `Logout`. The main content area displays the following information:

Status	Name: Phihong-654321	IP Address: 192.168.31.119	Firmware: v1.6	MAC Address: 00:24:6E:65:43:21
Port Control	Software Upgrade: <input type="text"/> <input type="button" value="Browse..."/> <input type="button" value="Upload"/>			
Configuration	Reboot: <input type="button" value="Reboot"/> and listen for <input type="text" value="0"/> seconds for a TFTP update			
Admin Management	Restore Factory Defaults: <input type="button" value="Restore Defaults"/>			

Note: Use POEB-* for "Software Upgrade", and use POEA-* for "TFTP update". Do "TFTP update" first.



6. Troubleshooting

If problems occur with the midspan, check the following troubleshooting table:

The troubleshooting solutions provided can only solve minor problems. If your problem is not listed, please contact our Phihong directly for further technical assistance. All up-to-date contact information can be found on our website www.phihong.com or www.midspans.com.

Troubleshooting

Problem	Possible Solutions
Midspan does not power up	<ol style="list-style-type: none"> 1. Ensure that the AC power cord is connected 2. Ensure that the AC power cord is in good condition 3. If solutions 1 and 2 are true; then disconnect the AC power cord and reconnect. Observe the Port LEDs to verify a proper power up.
Port LEDs do not illuminate "Green"	<ol style="list-style-type: none"> 1. The Port may be disabled and needs to be enabled using either the web or SNMP interfaces. Ensure that the Port in question is Enabled 2. Ensure the NIC Port is properly connected to the Network
The web interface won't open or cannot contact the unit via SNMP	Use the default IP address 10.0.2.5 and connect the midspan to the PC directly. Refer to the section <u>TFTP uploading (Power-On Reset Entry Mode)</u> for more details. If 10.0.2.5 will not open the correct webpage, check the network for any possible faults.
The web does not update the port status	Execute System Tools » Reboot
SNMP can't make contact	Check to see if the community strings are correct
For all other issues, please verify the following:	<ol style="list-style-type: none"> 1. Make sure the power is applied to the midspan 2. Make sure the network ethernet cable is not connected to the POE Data and Power port 3. Make sure the Data and Power cable is not connected to the Ethernet (NIC) power 4. Ensure the proper type of Ethernet cable is used. Do not use a crossover type of Ethernet cable.



7. Frequently Asked Questions

Q1: What should I do if I forgot the hostname?

A1: You can connect the Midspan to your PC directly, use default IP 10.0.2.5 to open the web or make SNMP contact (see details in section **TFTP uploading (Power-On Reset Entry Mode)**). You can find the hostname in the web display or read the contents of the OID <hostname> in SNMP.

Q2: What should I do if I forgot the login username and password?

A2: If you still know the SNMP community strings, open the SNMP interface and set a value '1' for the OID <restore>, the midspan restores itself to the factory defaults. You can reset with your new login username and password.

Q3: What should I do if I forget the SNMP community strings?

A3: If you still know the web login username and password, open System Tools in the web interface, click on the **Restore Defaults** button. Your midspan will restore to its factory default settings. You can reset your new Read-Write Community String and Read-Only Community Strings on the SNMP webpage.

Q4: What should I do if I forgot both login credentials and SNMP community strings?

A4: Please contact Pihong Support directly for further information on this topic.

Q5: There is no Configuration menu on the HTTP webpage, what should I do?

A5: Make sure that your web browser is compatible with the ones listed below. If it is not then upgrading would be the best solution.

Q6: My PC has Internet Explorer 7. After I use the Reboot function under the menu Configure/System Tools three times, the hostname link on Reboot page doesn't work anymore.

A6: Close the browser and re-open a new window. This is a known limitation with the Internet Explorer 7 program. There are no other known restrictions on IE7 at this time. You can also upgrade your Internet Explorer to latest version IE8. Other compatible web browsers include Firefox, Opera, Google Chrome, and Safari.