

HEXFET® Power MOSFET

- Ultra Low Gate Charge
- Reduced Gate Drive Requirement
- Enhanced 30V V_{GS} Rating
- Reduced C_{ISS} , C_{OSS} , C_{RSS}
- Isolated Central Mounting Hole
- Dynamic dv/dt Rated
- Repetitive Avalanche Rated

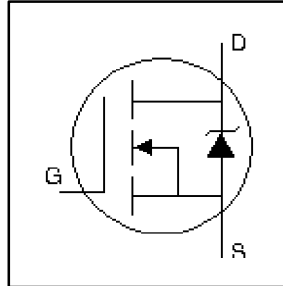

$$V_{DSS} = 500V$$

$$R_{DS(on)} = 0.40\Omega$$

$$I_D = 14A$$

Description

This new series of Low Charge HEXFET Power MOSFETs achieve significantly lower gate charge over conventional MOSFETs. Utilizing advanced Hexfet technology the device improvements allow for reduced gate drive requirements, faster switching speeds and increased total system savings. These device improvements combined with the proven ruggedness and reliability of HEXFETs offer the designer a new standard in power transistors for switching applications.

The TO-247 package is preferred for commercial-industrial applications where higher power levels preclude the use of TO-220 devices. The TO-247 is similar but superior to the earlier TO-218 package because of its isolated mounting hole.

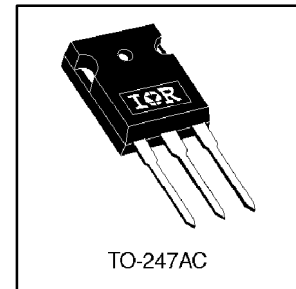

Absolute Maximum Ratings

	Parameter	Max.	Units
$I_D @ T_C = 25^\circ C$	Continuous Drain Current, $V_{GS} @ 10V$	14	A
$I_D @ T_C = 100^\circ C$	Continuous Drain Current, $V_{GS} @ 10V$	8.6	
I_{DM}	Pulsed Drain Current ①	56	
$P_D @ T_C = 25^\circ C$	Power Dissipation	190	W
	Linear Derating Factor	1.5	W/°C
V_{GS}	Gate-to-Source Voltage	± 30	V
E_{AS}	Single Pulse Avalanche Energy ②	760	mJ
I_{AR}	Avalanche Current ③	14	A
E_{AR}	Repetitive Avalanche Energy ①	19	mJ
dv/dt	Peak Diode Recovery dv/dt ③	3.5	V/ns
T_J	Operating Junction and	-55 to + 150	°C
T_{STG}	Storage Temperature Range		
	Soldering Temperature, for 10 seconds	300 (1.6mm from case)	
	Mounting torque, 6-32 or M3 screw.	10 lbf•in (1.1Nm)	

Thermal Resistance

	Parameter	Min.	Typ.	Max.	Units
$R_{\theta JC}$	Junction-to-Case	—	—	0.65	°C/W
$R_{\theta CS}$	Case-to-Sink, Flat, Greased Surface	—	0.24	—	
$R_{\theta JA}$	Junction-to-Ambient	—	—	40	

IRFP450LC



Electrical Characteristics @ $T_J = 25^\circ\text{C}$ (unless otherwise specified)

	Parameter	Min.	Typ.	Max.	Units	Conditions
$V_{(BR)DSS}$	Drain-to-Source Breakdown Voltage	500	—	—	V	$V_{GS} = 0V, I_D = 250\mu A$
$\Delta V_{(BR)DSS}/\Delta T_J$	Breakdown Voltage Temp. Coefficient	—	0.59	—	V/°C	Reference to $25^\circ\text{C}, I_D = 1\text{mA}$
$R_{DS(ON)}$	Static Drain-to-Source On-Resistance	—	—	0.40	Ω	$V_{GS} = 10V, I_D = 8.4A$ ④
$V_{GS(th)}$	Gate Threshold Voltage	2.0	—	4.0	V	$V_{DS} = V_{GS}, I_D = 250\mu A$
g_{fs}	Forward Transconductance	8.7	—	—	S	$V_{DS} = 50V, I_D = 8.4A$
I_{DSS}	Drain-to-Source Leakage Current	—	—	25	μA	$V_{DS} = 500V, V_{GS} = 0V$
		—	—	250		$V_{DS} = 400V, V_{GS} = 0V, T_J = 125^\circ\text{C}$
I_{GSS}	Gate-to-Source Forward Leakage	—	—	100	nA	$V_{GS} = 20V$
	Gate-to-Source Reverse Leakage	—	—	-100		$V_{GS} = -20V$
Q_g	Total Gate Charge	—	—	74	nC	$I_D = 14A$ $V_{DS} = 400V$ $V_{GS} = 10V$, See Fig. 6 and 13 ④
Q_{gs}	Gate-to-Source Charge	—	—	19		
Q_{gd}	Gate-to-Drain ("Miller") Charge	—	—	35		
$t_{d(on)}$	Turn-On Delay Time	—	14	—		
t_r	Rise Time	—	49	—	ns	$V_{DD} = 250V$ $I_D = 14A$ $R_G = 6.2\Omega$ $R_D = 17\Omega$, See Fig. 10 ④
$t_{d(off)}$	Turn-Off Delay Time	—	30	—		
t_f	Fall Time	—	30	—		
L_D	Internal Drain Inductance	—	5.0	—	nH	Between lead, 6mm (0.25in.) from package and center of die contact
L_S	Internal Source Inductance	—	13	—		
C_{iss}	Input Capacitance	—	2200	—	pF	$V_{GS} = 0V$ $V_{DS} = 25V$ $f = 1.0\text{MHz}$, See Fig. 5
C_{oss}	Output Capacitance	—	320	—		
C_{rss}	Reverse Transfer Capacitance	—	28	—		

Source-Drain Ratings and Characteristics

	Parameter	Min.	Typ.	Max.	Units	Conditions
I_S	Continuous Source Current (Body Diode)	—	—	14	A	MOSFET symbol showing the integral reverse p-n junction diode.
I_{SM}	Pulsed Source Current (Body Diode) ①	—	—	56		
V_{SD}	Diode Forward Voltage	—	—	1.4	V	$T_J = 25^\circ\text{C}, I_S = 14A, V_{GS} = 0V$ ②
t_{rr}	Reverse Recovery Time	—	580	870	ns	$T_J = 25^\circ\text{C}, I_F = 14A$
Q_{rr}	Reverse Recovery Charge	—	5.1	7.7	μC	$di/dt = 100A/\mu s$ ③
t_{on}	Forward Turn-On Time	Intrinsic turn-on time is negligible (turn-on is dominated by $L_S + L_D$)				

Notes:

- ① Repetitive rating; pulse width limited by max. junction temperature. (See fig. 11)
- ② $V_{DD} = 25V$, starting $T_J = 25^\circ\text{C}$, $L = 7.0\text{mH}$
 $R_G = 25\Omega, I_{AS} = 14A$. (See Figure 12)
- ③ $I_{SD} \leq 14A, di/dt \leq 130A/\mu s, V_{DD} \leq V_{(BR)DSS}, T_J \leq 150^\circ\text{C}$
- ④ Pulse width $\leq 300\mu s$; duty cycle $\leq 2\%$.



IRFP450LC

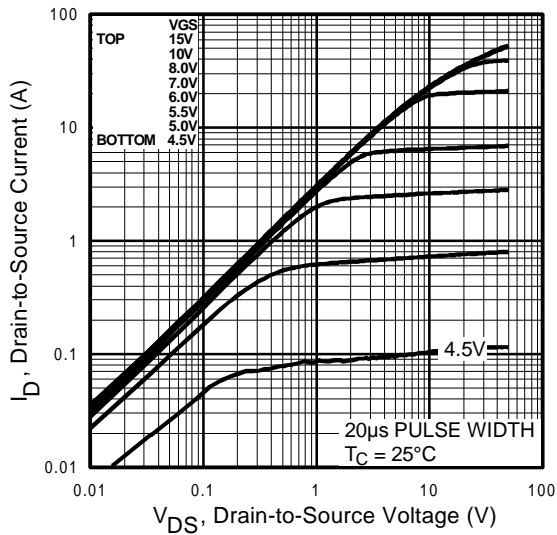

Fig 1. Typical Output Characteristics,
 $T_C = 25^\circ\text{C}$

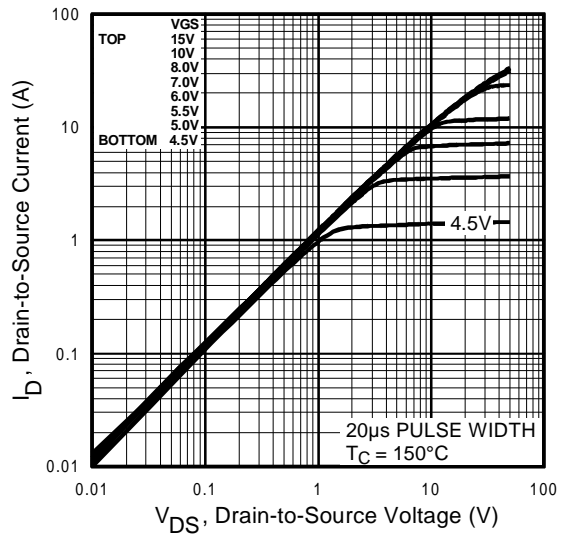

Fig 2. Typical Output Characteristics,
 $T_C = 150^\circ\text{C}$

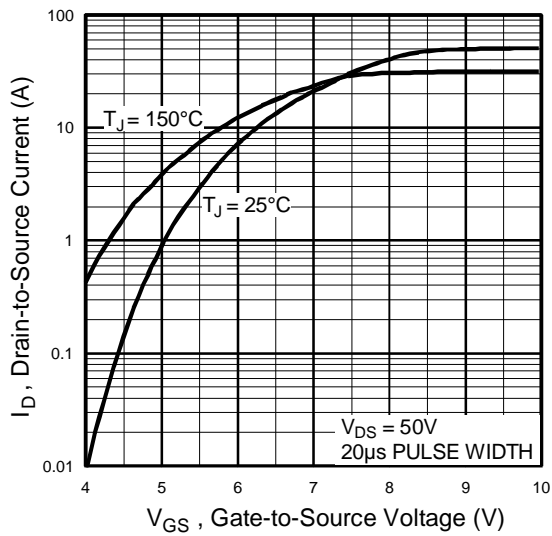

Fig 3. Typical Transfer Characteristics

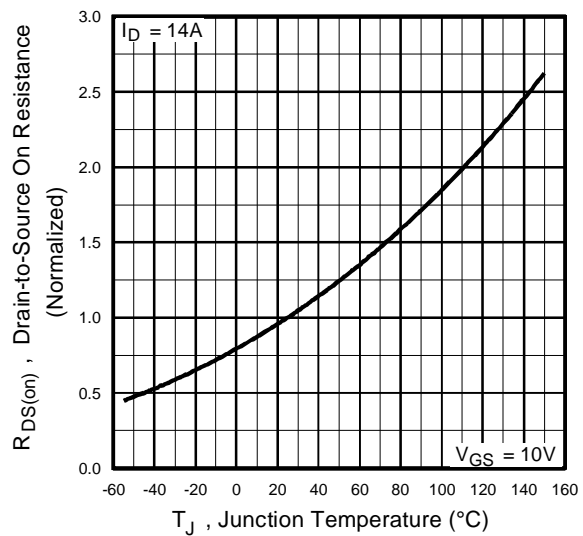

Fig 4. Normalized On-Resistance
Vs. Temperature

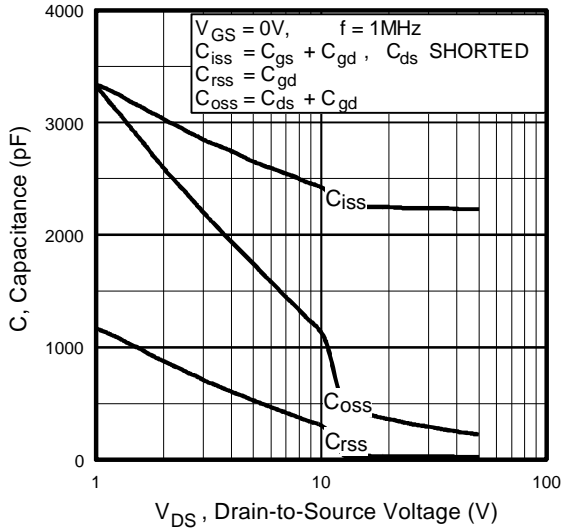

Fig 5. Typical Capacitance Vs. Drain-to-Source Voltage

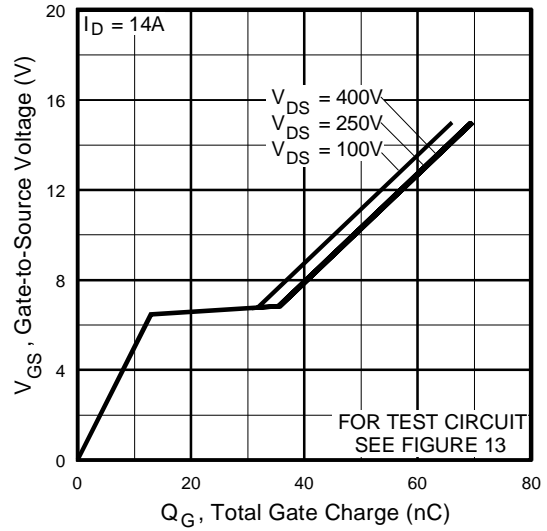

Fig 6. Typical Gate Charge Vs. Gate-to-Source Voltage

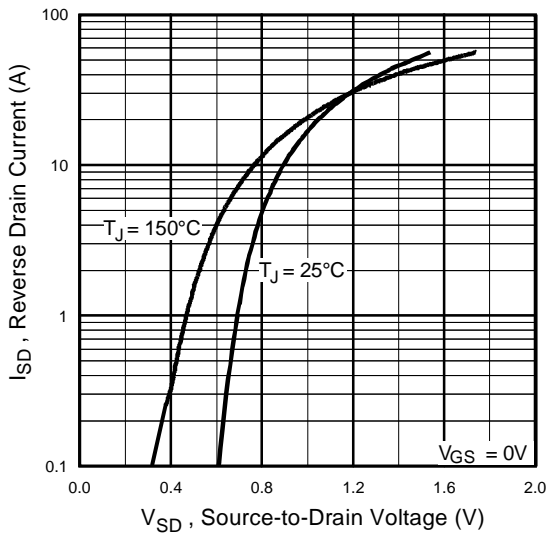

Fig 7. Typical Source-Drain Diode Forward Voltage

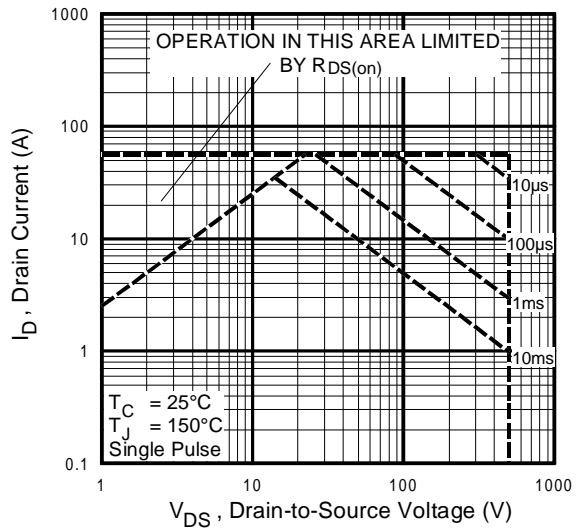

Fig 8. Maximum Safe Operating Area

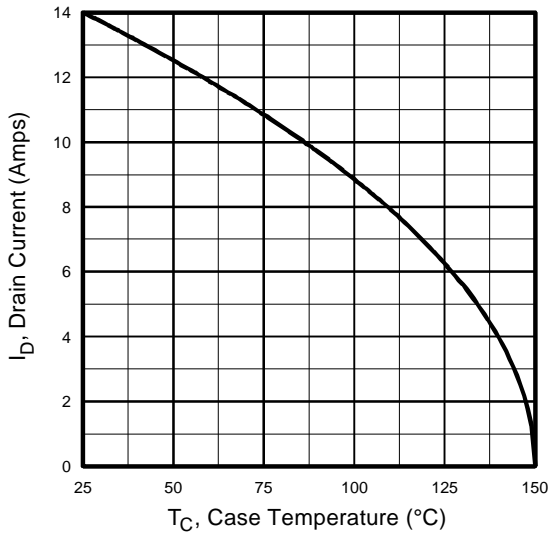

Fig 9. Maximum Drain Current Vs. Case Temperature

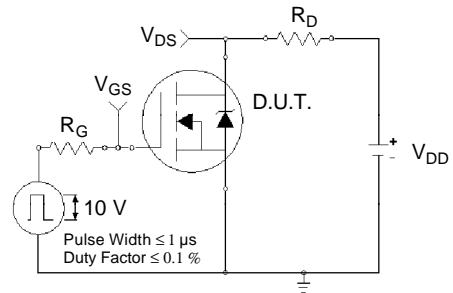

Fig 10a. Switching Time Test Circuit

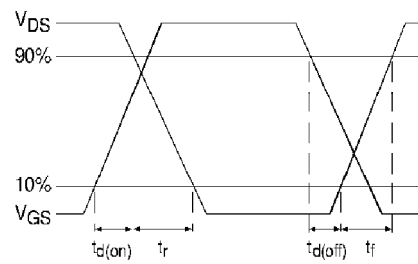

Fig 10b. Switching Time Waveforms

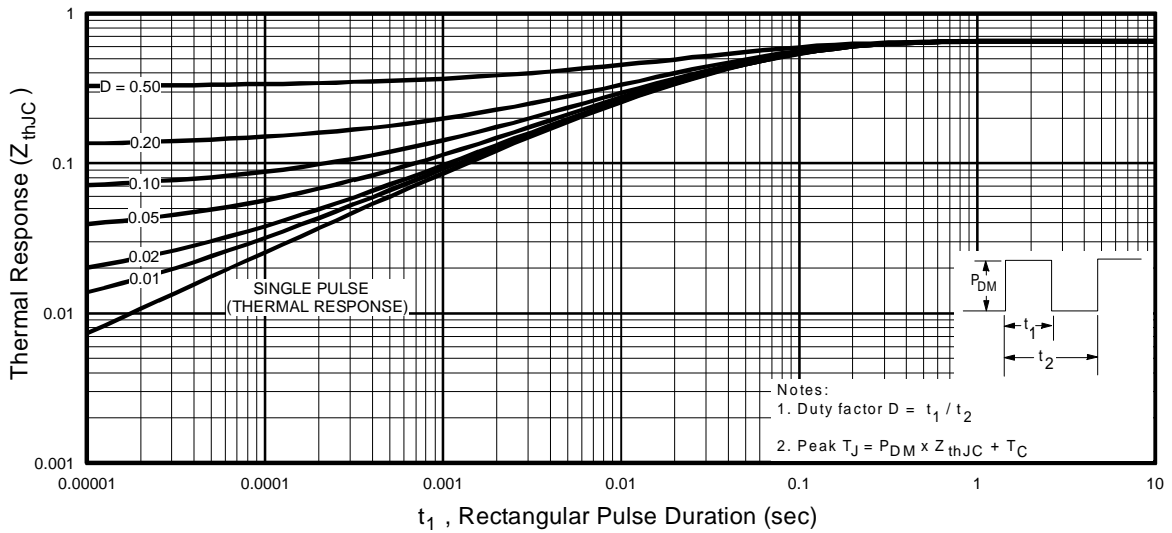

Fig 11. Maximum Effective Transient Thermal Impedance, Junction-to-Case

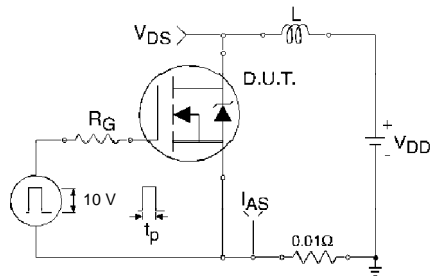

Fig 12a. Unclamped Inductive Test Circuit

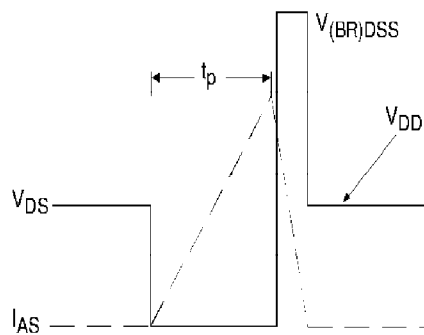

Fig 12b. Unclamped Inductive Waveforms

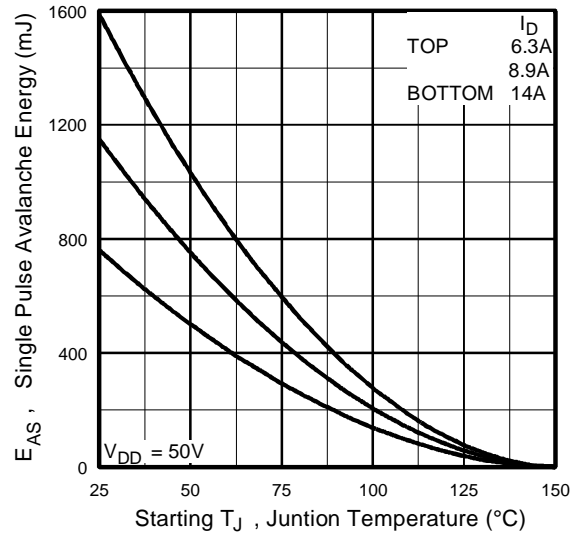

Fig 12c. Maximum Avalanche Energy Vs. Drain Current

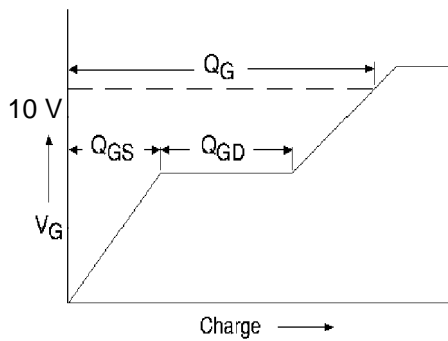

Fig 13a. Basic Gate Charge Waveform

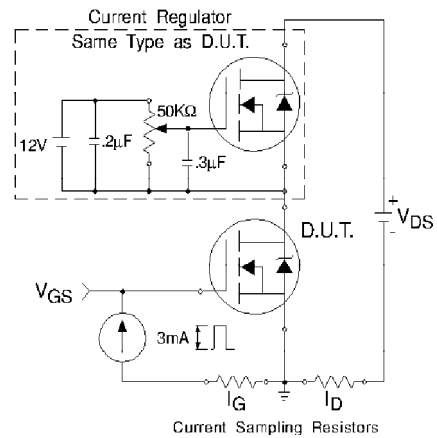
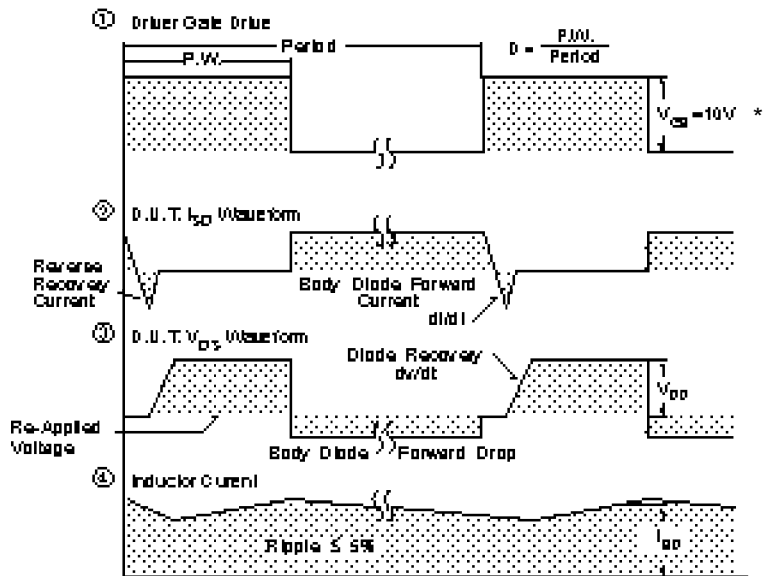
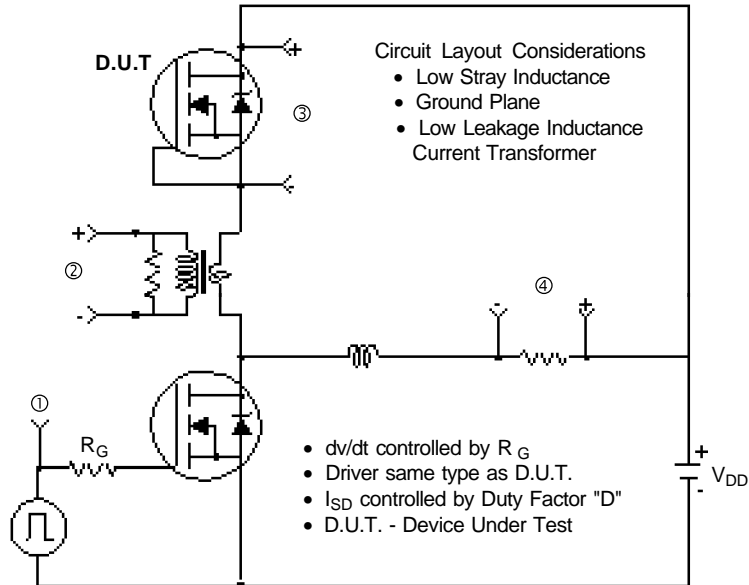

Fig 13b. Gate Charge Test Circuit

Peak Diode Recovery dv/dt Test Circuit



* $V_{GS} = 5V$ for Logic Level Devices

Fig 14. For N-Channel HEXFETS

IRF450LC



Package Outline TO-247AC

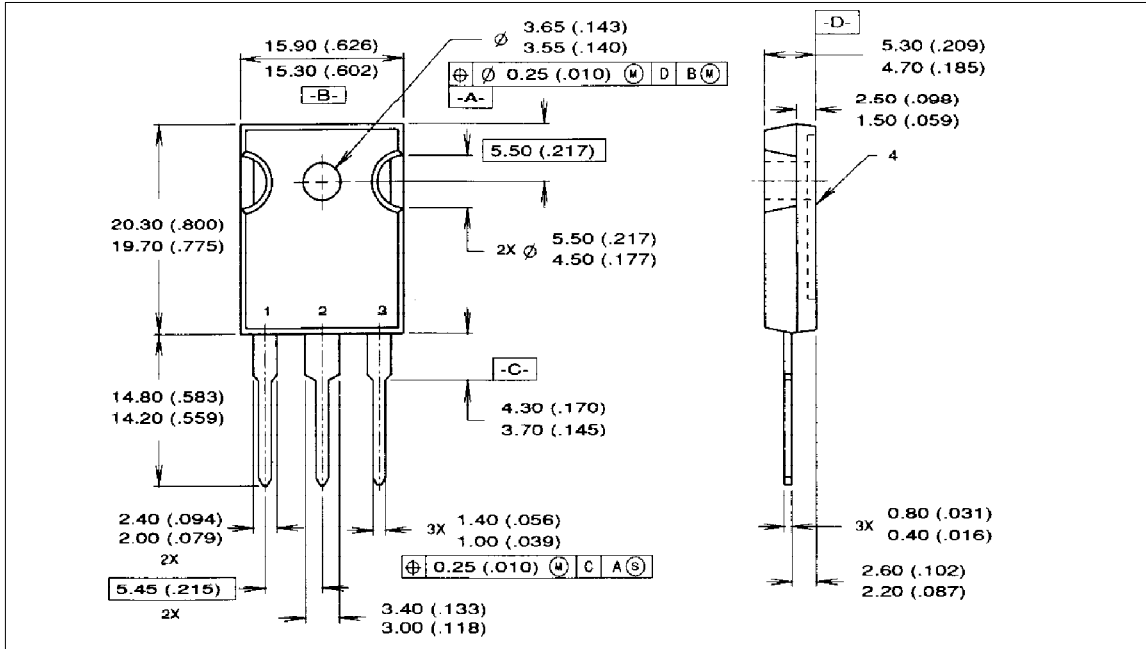

Part Marking Information TO-247AC

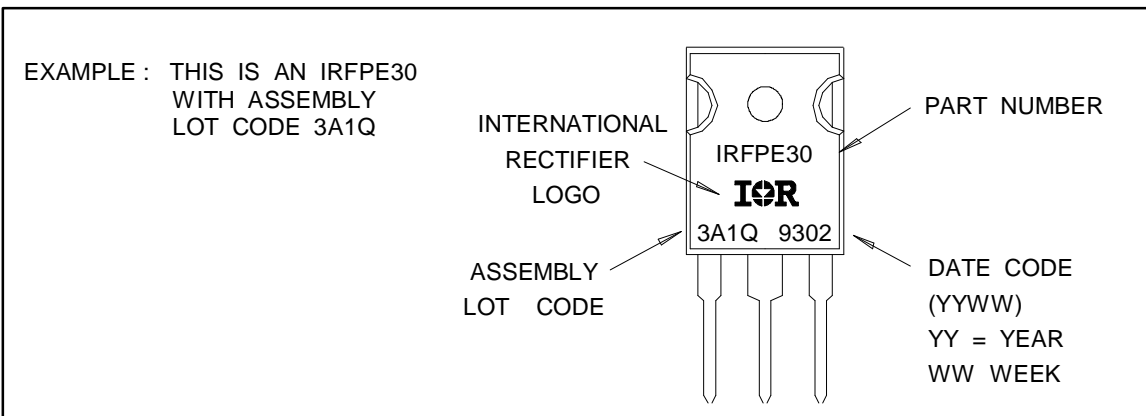

WORLD HEADQUARTERS: 233 Kansas St., El Segundo, California 90245, Tel: (310) 322 3331
EUROPEAN HEADQUARTERS: Hurst Green, Oxted, Surrey RH8 9BB, UK Tel: (44) 0883 713215
IR CANADA: 7321 Victoria Park Ave., Suite 201, Markham, Ontario L3R 3L1, Tel: (905) 475 1897
IR GERMANY: Saalburgstrasse 157, 61350 Bad Homburg Tel: 6172 37066
IR ITALY: Via Liguria 49, 10071 Borgaro, Torino Tel: (39) 1145 10111
IR FAR EAST: K&H Bldg., 2F, 3-30-4 Nishi-Ikeburo 3-Chome, Toshima-Ki, Tokyo 171 Tel: (03)3983 0641
IR SOUTHEAST ASIA: 315 Outram Road, #10-02 Tan Boon Liat Building, 0316 Tel: 65 221 8371

Data and specifications subject to change without notice.