

# Switching diode

**• Applications**

High speed switching

**• Features**

- 1) Extremely small surface mounting type.
- 2) High Speed.
- 3) High reliability.

**• Construction**

Silicon epitaxial planar

**L1SS400T1**

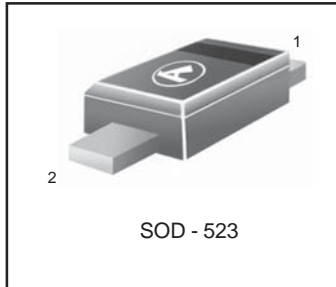

**ABSOLUTE MAXIMUM RATINGS (Ta = 25°C)**

Parameter	Symbol	Limits	Unit
Peak reverse voltage	$V_{RM}$	90	V
DC reverse voltage	$V_R$	80	V
Peak forward current	$I_{FM}$	225	mA
Mean rectifying current	$I_O$	100	mA
Surge current (1s)	$I_{surge}$	500	mA
Junction temperature	$T_j$	125	°C
Storage temperature	$T_{stg}$	- 55 ~ +125	°C

**ELECTRICAL CHARACTERISTICS (Ta = 25°C)**

Parameter	Symbol	Min.	Typ.	Max.	Unit	Conditions
Forward voltage	$V_F$	-	-	1.2	V	$I_F=100mA$
Reverse current	$I_R$	-	-	0.1	$\mu A$	$V_R=80V$
Capacitance between terminals	$C_T$	-	0.72	3.0	pF	$V_R=0.5V, f=1MHz$
Reverse recovery time	$t_{rr}$	-	-	4	ns	$V_R=6V, I_F=10mA, R_L=100$

L1SS400T1

ELECTRICAL CHARACTERISTIC CURVES  
( $T_a = 25^\circ\text{C}$ )

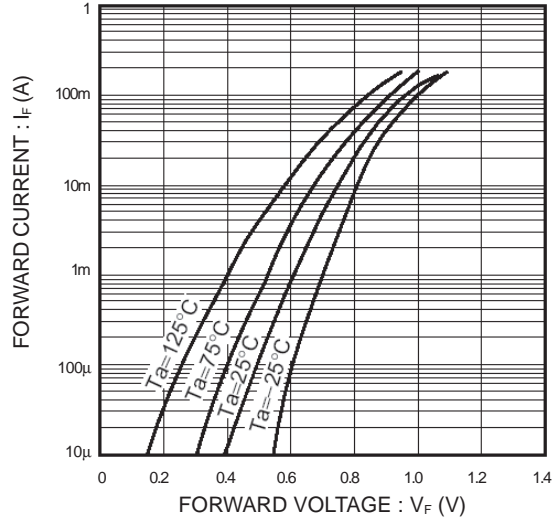

Fig.1 Forward characteristics

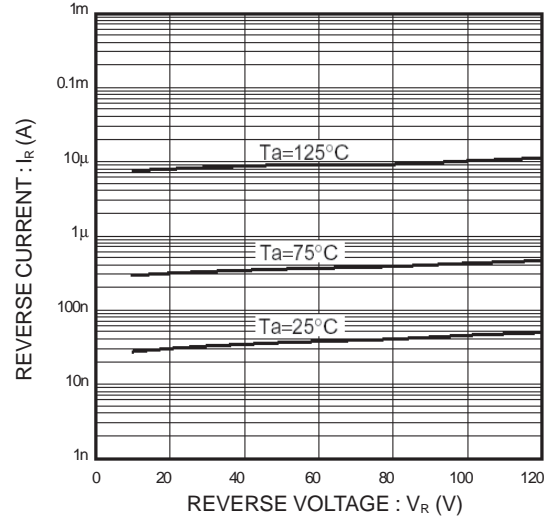

Fig.2 Reverse characteristics

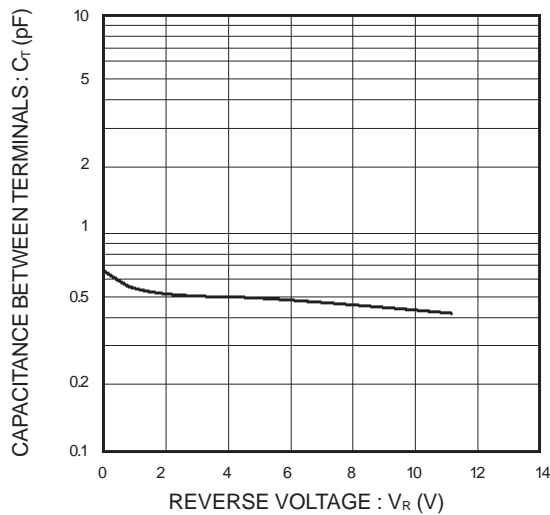

Fig.3 Capacitance between terminals

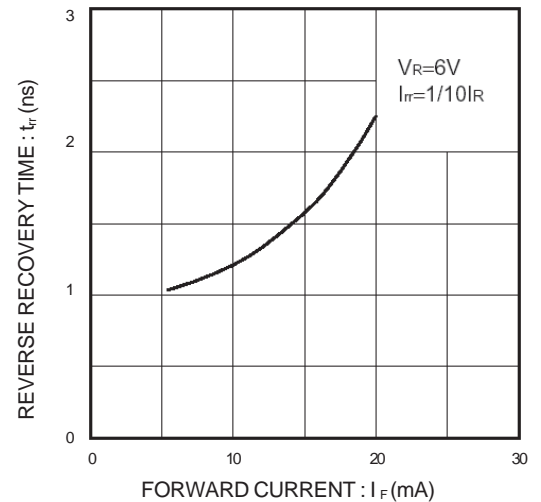

Fig.4 Reverse recovery time characteristics

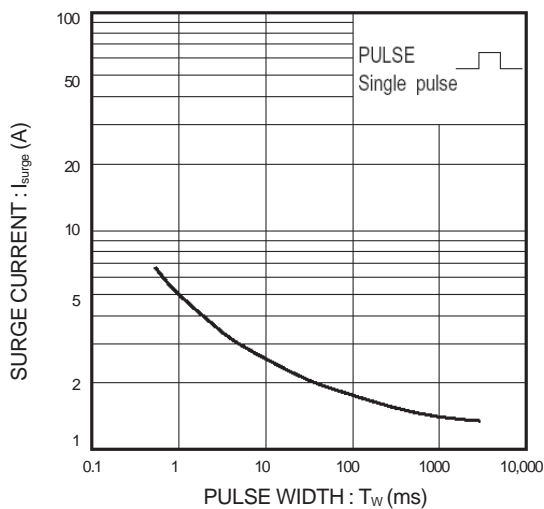

Fig.5 Surge current characteristics

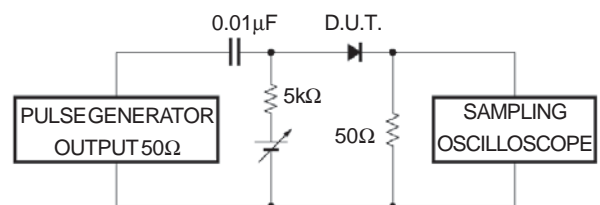
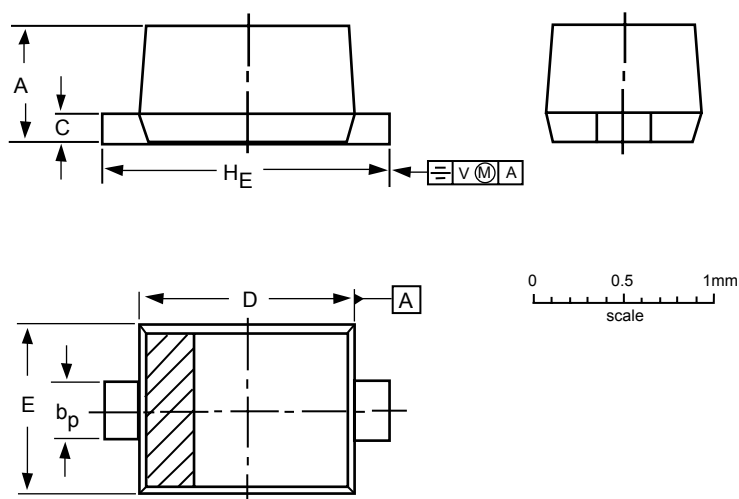

Fig.6 Reverse recovery time ( $t_{rr}$ ) measurement circuit

L1SS400T1

SC-79/SOD-523



**DIMENSIONS (mm are the original dimensions)**

UNIT	A	b <sub>p</sub>	c	D	E	H <sub>E</sub>	V
mm	0.7	0.35	0.2	1.3	0.9	1.7	0.15
	0.5	0.25	0.1	1.1	0.7	1.5	

**Note**

1. The marking bar indicates the cathode.

OUTLINE VERSION	REFERENCES			EUROPEAN PROJECTION	ISSUE DATE
	IEC	JEDEC	EIAJ		
SOD523			SC-79		98-11-25