

SMD Multilayer Chip Inductors

CLH Series

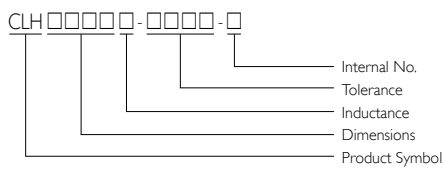

PRODUCT IDENTIFICATION



- Packaging: T = Tape and Reel, B = Bulk
- Internal No.: N = Lead-Free
- Product Series Identification:
 - CLH1005-S: Top side full mark, CLH1608-S: Top side full mark
 - CLH2012-S: White

SHAPES AND DIMENSIONS

CLH1005-S / CLH1608-S

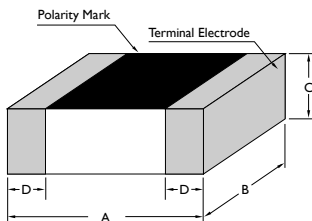

CLH2012-S

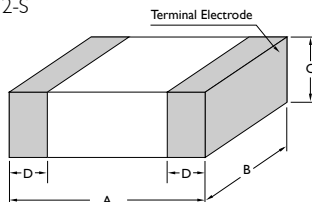

APPLICATIONS

RF Resonance and Impedance Matching Circuit

RF and Wireless Communication

Information technology equipment, computers, telecommunications, radar detectors, automotive electronics, cellular phones, pagers, PDAs, keyless remote systems.

Use in L-C Filter Configurations

OUTLINE

Yageo high frequency multilayer ceramic chip inductor is formed without wound wire.

Monolithic laminated structure

FEATURES

Meet RoHS Criteria for Lead-Free Product

Excellent Q Factor and SRF Characteristic

Cost Effective

Small size of 1005/1608 is suitable for small portable equipment.

Support operating frequency up to 6 GHz with nominal inductance values from 1.0 nH to 470 nH.

Unit: mm					
TYPE	INDUCTANCE RANGE	A	B	C	D
CLH1005	ALL	1.0 ± 0.10	0.50 ± 0.10	0.50 ± 0.10	0.25 ± 0.10
CLH1608	ALL	1.6 ± 0.15	0.8 ± 0.15	0.8 ± 0.15	0.3 ± 0.2
CLH2012	< 390 nH	2.0 ± 0.2	1.25 ± 0.2	0.9 ± 0.2	0.5 ± 0.3
CLH2012	≥ 390 nH	2.0 ± 0.2	1.25 ± 0.2	1.25 ± 0.2	0.5 ± 0.3

ELECTRICAL CHARACTERISTICS CLH1005-N

PART NO.	INDUCTANCE at 100MHz (nH)	TOLERANCE	Q Min.	Q TYPICAL		SRF (MHz) Min.	DC RESISTANCE (Ω) Max.	RATED CURRENT (mA) Max.
			at 100MHz	at 100MHz	at 800MHz			
CLH1005T-1N0□-N	1.0	S	8	9	28	10,000	0.10	400
CLH1005T-1N2□-N	1.2	S	8	9	28	10,000	0.10	400
CLH1005T-1N5□-N	1.5	S	8	10	28	9,000	0.10	400
CLH1005T-1N8□-N	1.8	S	8	10	28	8,700	0.10	400
CLH1005T-2N2□-N	2.2	S	8	10	29	8,100	0.15	400
CLH1005T-2N7□-N	2.7	S	8	11	30	7,700	0.15	400
CLH1005T-3N3□-N	3.3	S / K	8	11	30	6,300	0.15	400
CLH1005T-3N9□-N	3.9	S / K	8	11	31	6,100	0.20	400
CLH1005T-4N7□-N	4.7	S / K	8	11	31	5,400	0.20	400
CLH1005T-5N6□-N	5.6	S / K	8	11	31	5,100	0.20	400
CLH1005T-6N8□-N	6.8	J / K	8	11	33	4,550	0.25	400
CLH1005T-8N2□-N	8.2	J / K	8	12	32	4,100	0.30	300
CLH1005T-10N□-N	10	J / K	8	12	32	3,900	0.35	300
CLH1005T-12N□-N	12	J / K	8	12	31	3,000	0.40	300
CLH1005T-15N□-N	15	J / K	8	12	30	2,800	0.50	300
CLH1005T-18N□-N	18	J / K	8	12	29	2,500	0.55	300
CLH1005T-22N□-N	22	J / K	8	12	28	2,200	0.70	300
CLH1005T-27N□-N	27	J / K	8	12	27	2,000	0.80	300
CLH1005T-33N□-N	33	J / K	8	10	25	1,800	0.90	200
CLH1005T-39N□-N	39	J / K	8	10	25	1,600	1.00	150
CLH1005T-47N□-N	47	J / K	8	10	22	1,400	1.20	150
CLH1005T-56N□-N	56	J / K	8	10	21	1,300	1.30	150
CLH1005T-68N□-N	68	J / K	8	10	15	1,100	1.50	100
CLH1005T-82N□-N	82	J / K	8	10	13	1,000	1.60	100
CLH1005T-R10□-N	100	J / K	8	10	10	900	2.00	100
CLH1005T-R12□-N	120	J / K	8	10	-	800	2.20	100

Note:

Tolerance: S = ± 0.3 nH, J = $\pm 5\%$, K = $\pm 10\%$

Test Instruments: L/Q- Agilent E4991A, Fixture- Agilent 16197A

SRF- HP8753D

RDC- HP4338B/CH502BC



ELECTRICAL CHARACTERISTICS CLHI608-N

PART NO.	INDUCTANCE at 100MHz (nH)	TOLERANCE	Q Min.		Q TYPICAL					SRF (MHz) Min.	DC RESISTANCE (Ω) Max.	RATED CURRENT (mA) Max.	
			at 50MHz	at 100MHz	at 50MHz	at 100MHz	at 300MHz	at 500MHz	at 800MHz				
CLHI608T-1N05-N	1.0	S		8		12				60	10,000	0.10	600
CLHI608T-1N25-N	1.2	S		8		13				60	10,000	0.10	600
CLHI608T-1N55-N	1.5	S		8		13				57	8,000	0.10	600
CLHI608T-1N85-N	1.8	S		8		13				51	8,000	0.10	600
CLHI608T-2N25-N	2.2	S		8		13				46	7,200	0.10	600
CLHI608T-2N75-N	2.7	S		10		13				46	6,200	0.10	600
CLHI608T-3N3□-N	3.3	S / K		10		13				47	5,200	0.12	600
CLHI608T-3N9□-N	3.9	S / K		10		13				47	5,000	0.14	600
CLHI608T-4N7□-N	4.7	S / K		10		13				41	4,750	0.16	600
CLHI608T-5N6□-N	5.6	S / K		10		13				41	4,100	0.18	600
CLHI608T-6N8□-N	6.8	J / K		10		13				44	3,750	0.22	600
CLHI608T-8N2□-N	8.2	J / K		10		13				44	3,300	0.24	600
CLHI608T-10N□-N	10	J / K		12		13				45	3,000	0.26	600
CLHI608T-12N□-N	12	J / K		12		15				46	2,600	0.28	600
CLHI608T-15N□-N	15	J / K		12		15				48	2,500	0.32	600
CLHI608T-18N□-N	18	J / K		12		15				48	2,400	0.35	600
CLHI608T-22N□-N	22	J / K		12		17				45	2,000	0.40	500
CLHI608T-27N□-N	27	J / K		12		17				43	1,900	0.45	500
CLHI608T-33N□-N	33	J / K		12		18				39	1,600	0.55	400
CLHI608T-39N□-N	39	J / K		12		18		37			1,400	0.60	400
CLHI608T-47N□-N	47	J / K		12		18		35			1,300	0.70	400
CLHI608T-56N□-N	56	J / K		12		18		32			1,100	0.75	400
CLHI608T-62N□-N	62	J / K		12		18		34			1,050	0.85	400
CLHI608T-68N□-N	68	J / K		12		18		34			1,050	0.85	400
CLHI608T-82N□-N	82	J / K		12		18		32			900	1.00	300
CLHI608T-R10□-N	100	J / K		12		18		20			770	1.20	300
CLHI608T-R12□-N	*120	J / K	8			14		20			650	1.30	300
CLHI608T-R15□-N	*150	J / K	8			15		16			550	1.70	250
CLHI608T-R18□-N	*180	J / K	8			15		16			520	1.90	250
CLHI608T-R22□-N	*220	J / K	8			15		16			500	2.00	250
CLHI608T-R27□-N	*270	J / K	8			13		14			470	2.20	150
CLHI608T-R33□-N	*330	J / K	8			13		-			320	2.80	100
CLHI608T-R39□-N	*390	J / K	8			13		-			300	3.00	100

Note:

* at 50MHz

Tolerance: S = ± 0.3 nH, J = ± 5%, K = ± 10%

Test Instruments: L/Q- HP4291A+HP16192A

SRF- HP4291A+HP16192A

RDC- HP4338B/ CH502BC

IDC- HP4291A+HP6632A

ELECTRICAL CHARACTERISTICS CLH2012-N

PART NO.	INDUCTANCE at 100MHz (nH)	TOLERANCE	Q Min.		Q TYPICAL			SRF (MHz) Min.	DC RESISTANCE (Ω) Max.	RATED CURRENT (mA) Max.
			at 50MHz	at 100MHz	at 50MHz	at 100MHz	at 800MHz			
CLH2012T-1N0□-N	1.0	S		10		13	40	> 6000	0.10	300
CLH2012T-1N2□-N	1.2	S		10		13	40	> 6000	0.10	300
CLH2012T-1N5□-N	1.5	S		10		13	40	> 6000	0.10	300
CLH2012T-1N8□-N	1.8	S		10		13	45	> 6000	0.10	300
CLH2012T-2N2□-N	2.2	S		10		13	48	> 6000	0.10	300
CLH2012T-2N7□-N	2.7	S		12		13	48	> 6000	0.10	300
CLH2012T-3N3□-N	3.3	S / K		12		15	56	> 6000	0.13	300
CLH2012T-3N9□-N	3.9	S / K		12		15	54	5,400	0.15	300
CLH2012T-4N7□-N	4.7	S / K		12		15	50	4,500	0.20	300
CLH2012T-5N6□-N	5.6	S / K		12		15	53	4,000	0.23	300
CLH2012T-6N8□-N	6.8	J / K		15		15	51	3,650	0.25	300
CLH2012T-8N2□-N	8.2	J / K		15		15	53	3,000	0.28	300
CLH2012T-10N□-N	10	J / K		15		16	45	2,500	0.30	300
CLH2012T-12N□-N	12	J / K		15		16	48	2,450	0.35	300
CLH2012T-15N□-N	15	J / K		15		17	48	2,000	0.40	300
CLH2012T-18N□-N	18	J / K		15		17	43	1,750	0.45	300
CLH2012T-22N□-N	22	J / K		15		17	40	1,700	0.50	300
CLH2012T-27N□-N	27	J / K		15		18	38	1,550	0.55	300
CLH2012T-33N□-N	33	J / K		15		19	35	1,350	0.60	300
CLH2012T-39N□-N	39	J / K		18		21	37	1,300	0.65	300
CLH2012T-47N□-N	47	J / K		18		21	38	1,200	0.70	300
CLH2012T-56N□-N	56	J / K		18		21	31	1,150	0.75	300
CLH2012T-68N□-N	68	J / K		18		21	28	1,000	0.80	300
CLH2012T-82N□-N	82	J / K		18		22	16	850	0.90	300
CLH2012T-R10□-N	100	J / K		18		23		730	1.00	300
CLH2012T-R12□-N	* 120	J / K	13		16	22		650	1.20	300
CLH2012T-R15□-N	* 150	J / K	13		16	22		550	1.40	300
CLH2012T-R18□-N	* 180	J / K	13		16	23		500	1.80	300
CLH2012T-R22□-N	* 220	J / K	12		14	20		450	2.00	300
CLH2012T-R27□-N	* 270	J / K	12		14	20		400	2.50	200
CLH2012T-R33□-N	* 330	J / K	12		14	22		380	3.00	200
CLH2012T-R39□-N	* 390	J / K	10		14	22		330	3.50	200
CLH2012T-R47□-N	* 470	J / K	10		14	22		300	4.00	200

Note:

* at 50MHz

Tolerance: S = ± 0.3 nH, J = $\pm 5\%$, K = $\pm 10\%$

Test Instruments: L/Q- Agilent E4991A, Fixture- Agilent 16197A

SRF- HP8753D

RDC- HP4338B/CH502BC



TAPE DIMENSIONS

Unit: mm

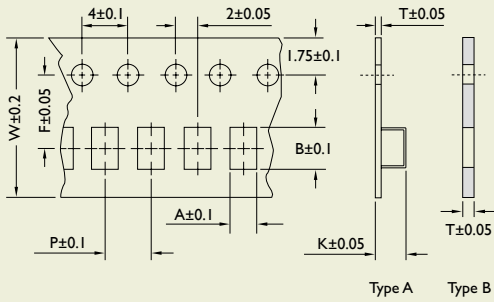

TYPE	A	B	T	W	P	F	K	TAPE TYPE
CLH1005	0.65	1.15	0.60	8	2	3.5	-	B
CLH1608	1.00	1.80	0.95	8	4	3.5	-	B
CLH201209	1.42	2.25	0.22	8	4	3.5	1.04	A/B
CLH201212	1.35	2.25	0.22	8	4	3.5	1.35	A

TAPE MATERIAL

PACKAGING QUANTITY

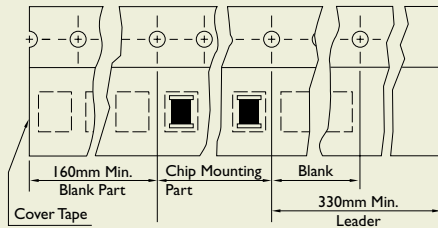

TYPE	QUANTITY/REEL
CLH1005	10,000
CLH1608	4,000
CLH201209	4,000
CLH201212	3,000

REEL DIMENSIONS

Unit: mm

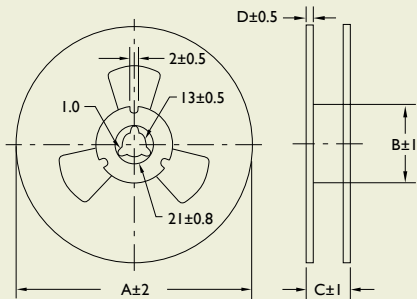

TYPE	A	B	C	D
CLH1005	178	60	12	1.5
CLH1608	178	60	12	1.5
CLH201209	178	60	12	1.5
CLH201212	178	60	12	1.5

RECOMMENDED PATTERN

Unit: mm

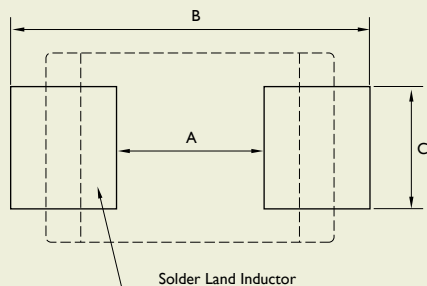

TYPE	A	B	C
CLH1005	0.40	1.2 ~ 1.4	0.40
CLH1608	0.80	2.4 ~ 3.4	0.60
CLH201209	1.20	3.0 ~ 4.0	1.00
CLH201212	1.20	3.0 ~ 4.0	1.00