

---

# 2SK1151(L)(S), 2SK1152(L)(S)

Silicon N-Channel MOS FET

# HITACHI

November 1996

---

## Application

High speed power switching

## Features

- Low on-resistance
- High speed switching
- Low drive current
- No secondary breakdown
- Suitable for switching regulator and DC-DC converter

## Outline

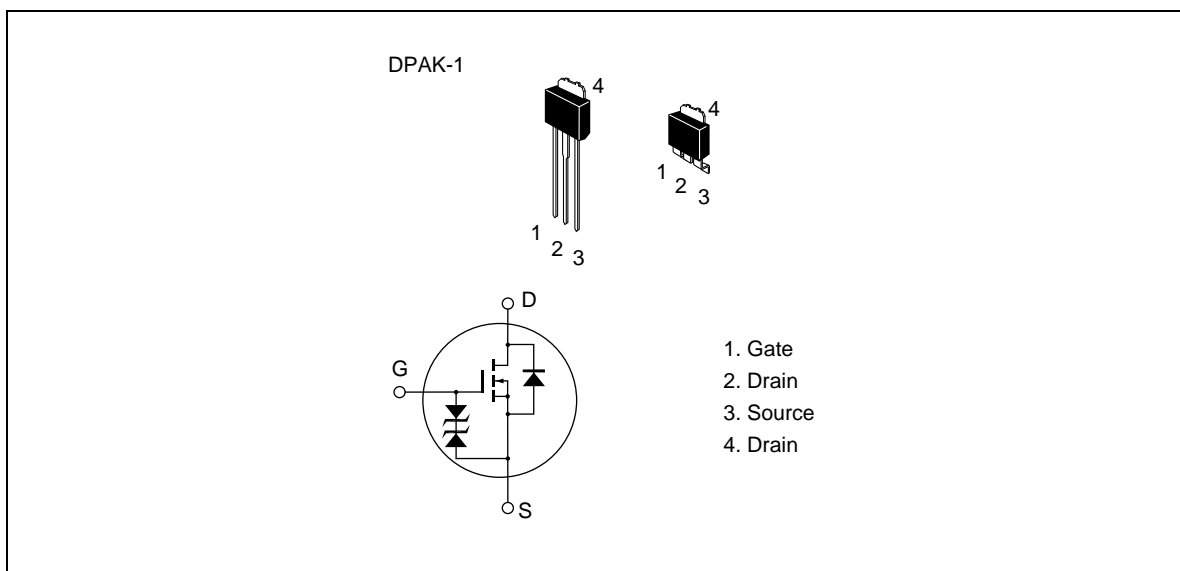

---

## 2SK1151(L)(S), 2SK1152(L)(S)

---

### Absolute Maximum Ratings (Ta = 25°C)

Item		Symbol	Ratings	Unit
Drain to source voltage	2SK1151	$V_{DSS}$	450	V
	2SK1152		500	
Gate to source voltage		$V_{GSS}$	±30	V
Drain current		$I_D$	1.5	A
Drain peak current		$I_{D(pulse)}^{*1}$	6	A
Body to drain diode reverse drain current		$I_{DR}$	1.5	A
Channel dissipation		$Pch^{*2}$	20	W
Channel temperature		Tch	150	°C
Storage temperature		Tstg	-55 to +150	°C

- Note
1.  $PW \leq 10 \mu s$ , duty cycle  $\leq 1\%$
  2. Value at  $T_c = 25^\circ C$

## 2SK1151(L)(S), 2SK1152(L)(S)

### Electrical Characteristics (Ta = 25°C)

Item	Symbol	Min	Typ	Max	Unit	Test conditions
Drain to source breakdown voltage	2SK1151 $V_{(BR)DSS}$ 2SK1152	450	—	—	V	$I_D = 10 \text{ mA}, V_{GS} = 0$
Gate to source breakdown voltage	$V_{(BR)GSS}$	±30	—	—	V	$I_G = \pm 100 \mu\text{A}, V_{DS} = 0$
Gate to source leak current	$I_{GSS}$	—	—	±10	μA	$V_{GS} = \pm 25 \text{ V}, V_{DS} = 0$
Zero gate voltage drain current	2SK1151 $I_{DSS}$ 2SK1152	—	—	100	μA	$V_{DS} = 360 \text{ V}, V_{GS} = 0$ $V_{DS} = 400 \text{ V}, V_{GS} = 0$
Gate to source cutoff voltage	$V_{GS(off)}$	2.0	—	3.0	V	$I_D = 1 \text{ mA}, V_{DS} = 10 \text{ V}$
Static Drain to source on stateresistance	2SK1151 $R_{DS(on)}$ 2SK1152	—	3.5	5.5	Ω	$I_D = 1 \text{ A}, V_{GS} = 10 \text{ V}^{*1}$
Forward transfer admittance	yfs	0.6	1.1	—	S	$I_D = 1 \text{ A}, V_{DS} = 20 \text{ V}^{*1}$
Input capacitance	Ciss	—	160	—	pF	$V_{DS} = 10 \text{ V}, V_{GS} = 0,$ $f = 1 \text{ MHz}$
Output capacitance	Coss	—	45	—	pF	
Reverse transfer capacitance	Crss	—	5	—	pF	
Turn-on delay time	$t_{d(on)}$	—	5	—	ns	$I_D = 1 \text{ A}, V_{GS} = 10 \text{ V},$ $R_L = 30 \Omega$
Rise time	$t_r$	—	10	—	ns	
Turn-off delay time	$t_{d(off)}$	—	20	—	ns	
Fall time	$t_f$	—	10	—	ns	
Body to drain diode forward voltage	$V_{DF}$	—	1.0	—	V	$I_F = 1.5 \text{ A}, V_{GS} = 0$
Body to drain diode reverse recovery time	$t_{rr}$	—	220	—	ns	$I_F = 1.5 \text{ A}, V_{GS} = 0,$ $di_F/dt = 100 \text{ A}/\mu\text{s}$

Note 1. Pulse test

## 2SK1151(L)(S), 2SK1152(L)(S)

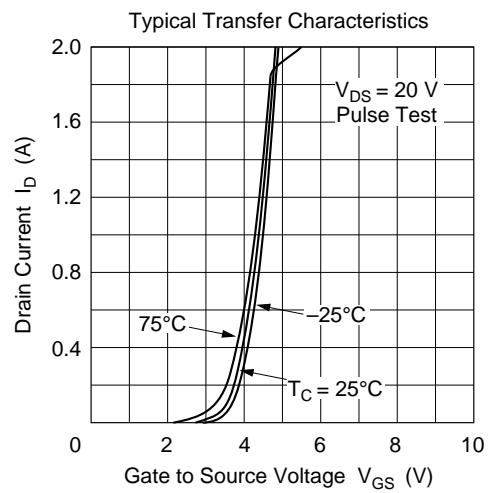
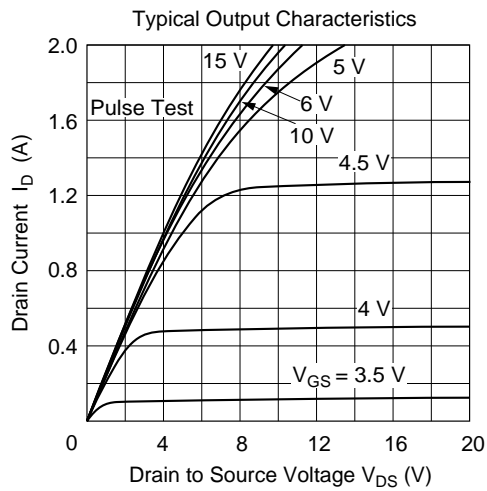
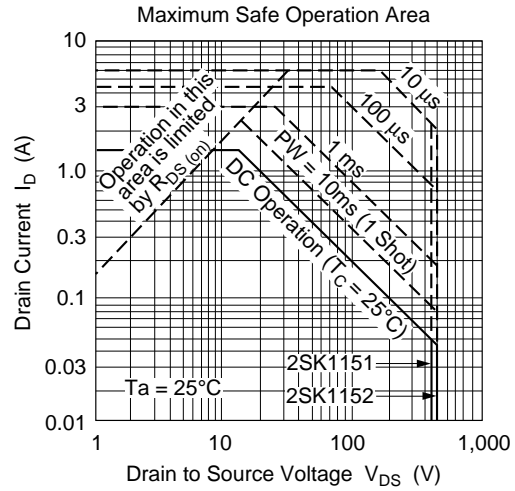
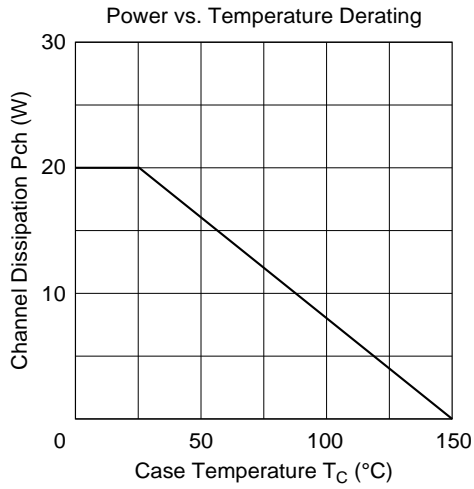

## 2SK1151(L)(S), 2SK1152(L)(S)

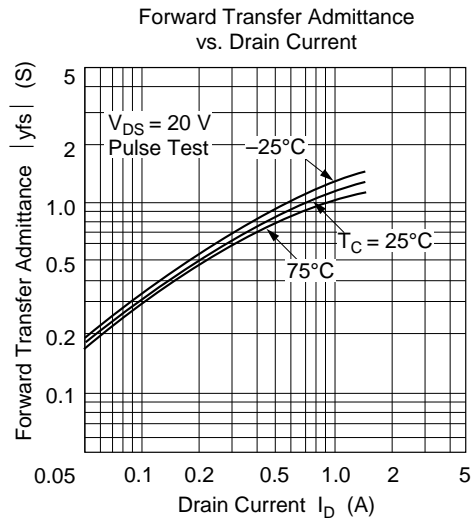
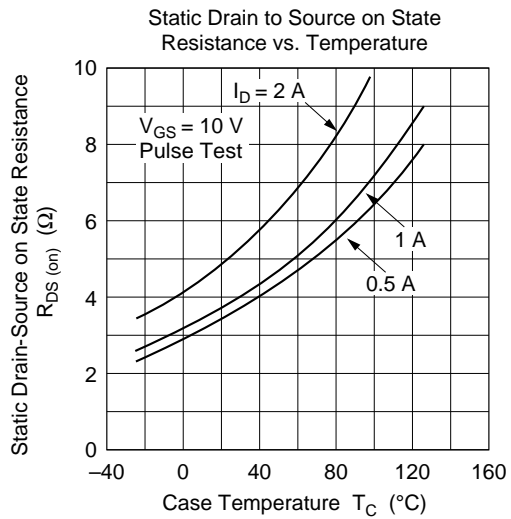
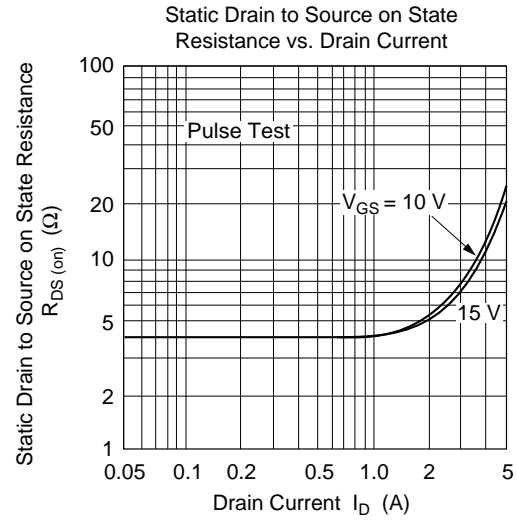
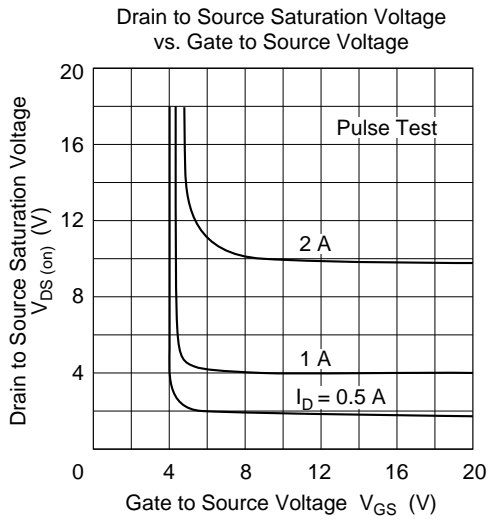

## 2SK1151(L)(S), 2SK1152(L)(S)

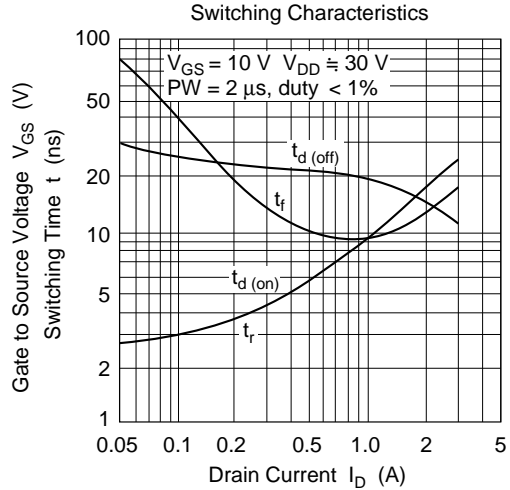
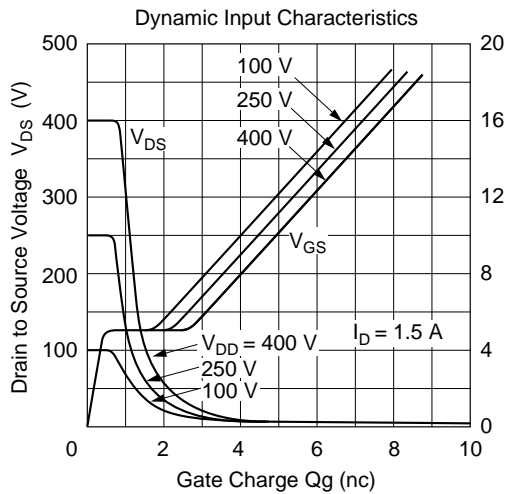
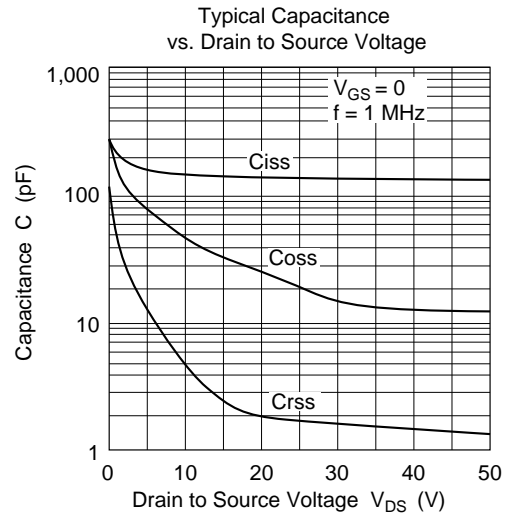
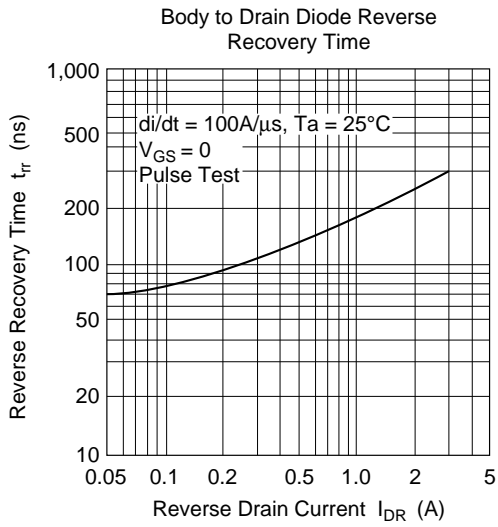

## 2SK1151(L)(S), 2SK1152(L)(S)

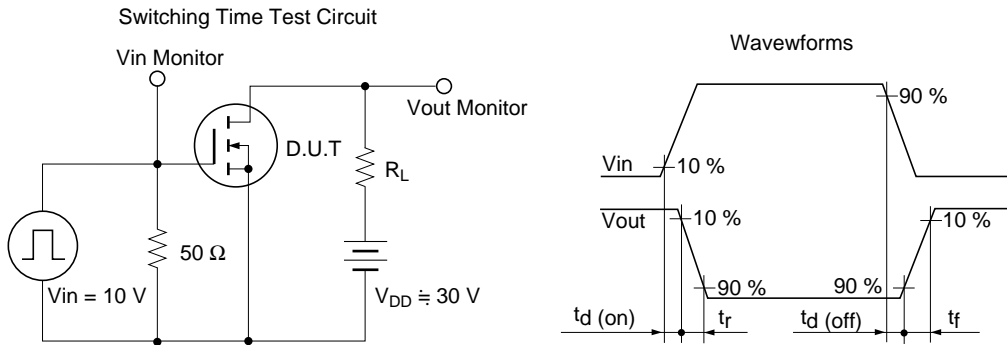
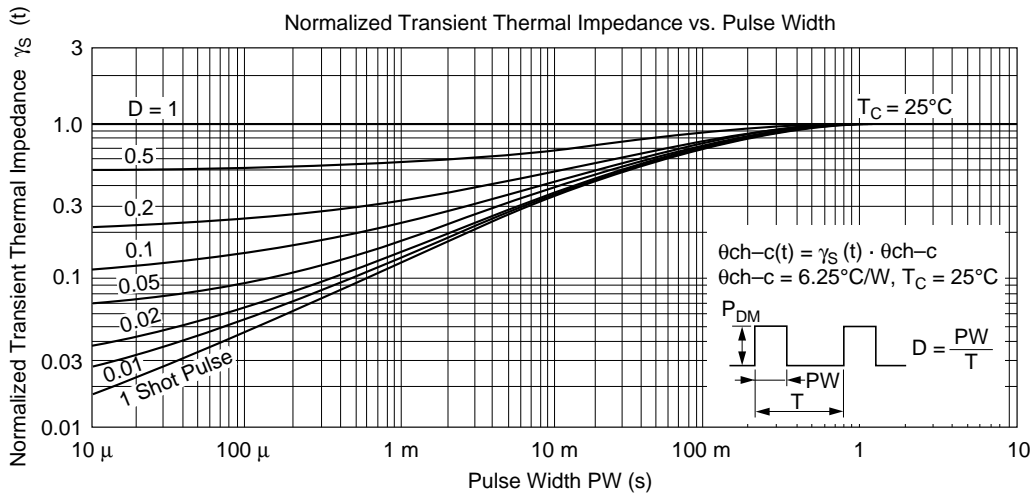
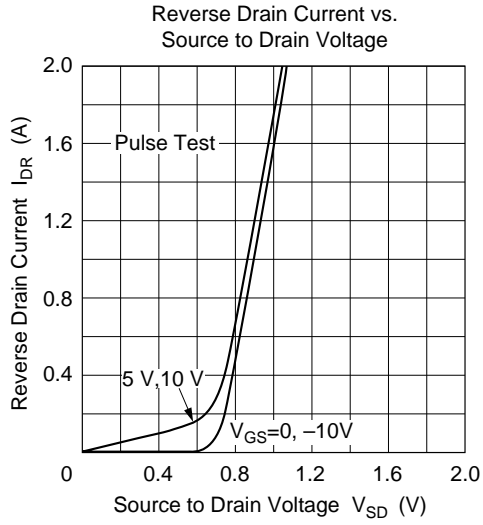

---

## 2SK1151(L)(S), 2SK1152(L)(S)

---

When using this document, keep the following in mind:

1. This document may, wholly or partially, be subject to change without notice.
2. All rights are reserved: No one is permitted to reproduce or duplicate, in any form, the whole or part of this document without Hitachi's permission.
3. Hitachi will not be held responsible for any damage to the user that may result from accidents or any other reasons during operation of the user's unit according to this document.
4. Circuitry and other examples described herein are meant merely to indicate the characteristics and performance of Hitachi's semiconductor products. Hitachi assumes no responsibility for any intellectual property claims or other problems that may result from applications based on the examples described herein.
5. No license is granted by implication or otherwise under any patents or other rights of any third party or Hitachi, Ltd.
6. **MEDICAL APPLICATIONS:** Hitachi's products are not authorized for use in **MEDICAL APPLICATIONS** without the written consent of the appropriate officer of Hitachi's sales company. Such use includes, but is not limited to, use in life support systems. Buyers of Hitachi's products are requested to notify the relevant Hitachi sales offices when planning to use the products in **MEDICAL APPLICATIONS**.