



LIGITEK

LIGITEK ELECTRONICS CO.,LTD.  
Property of Ligitek Only

---

**SUPER BRIGHT ROUND TYPE LED LAMPS**



Lead-Free Parts

**L8UG2040-PF**

**DATA SHEET**

DOC. NO : QW0905-L8UG2040-PF

REV. : A

DATE : 14 - Nov. - 2007



### Package Dimensions

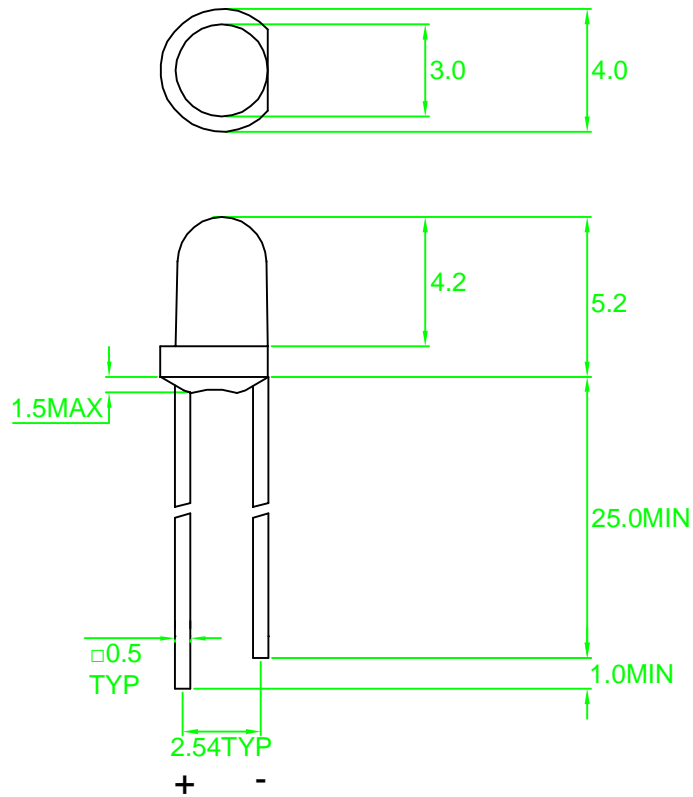

Note : 1.All dimension are in millimeter tolerance is  $\pm 0.25\text{mm}$  unless otherwise noted.  
2.Specifications are subject to change without notice.

### Directivity Radiation

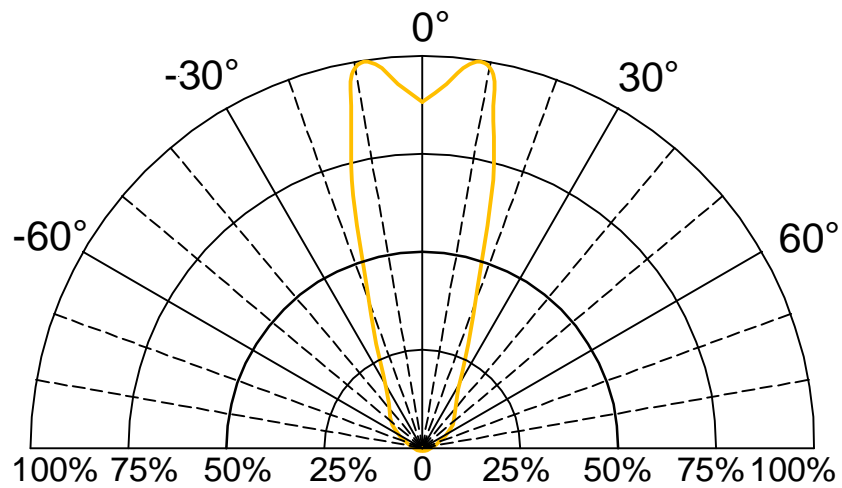

**Absolute Maximum Ratings at Ta=25 °C**

| Parameter                               | Symbol | Ratings    | UNIT |
|---|--------|------------|------|
|   |        | 8UG        |      |
| Forward Current                         | IF     | 25         | mA   |
| Peak Forward Current<br>Duty 1/10@10KHz | IFP    | 75         | mA   |
| Power Dissipation                       | PD     | 65         | mW   |
| Reverse Current @5V                     | Ir     | 10         | μA   |
| Electrostatic Discharge( * )            | ESD    | 2000       | V    |
| Operating Temperature                   | Topr   | -40 ~ +85  | °C   |
| Storage Temperature                     | Tstg   | -40 ~ +100 | °C   |

\* Static Electricity or power surge will damage the LED. Use of a conductive wrist band or anti-electrostatic glove is recommended when handling these LED. All devices, equipment and machinery must be properly grounded.

**Typical Electrical & Optical Characteristics (Ta=25 °C)**

| PART NO     | MATERIAL | COLOR   |                | Dominant wave length<br>λ Dnm | Spectral halfwidth<br>Δ λ nm | Forward voltage<br>@ 20mA(V) |      | Luminous intensity<br>@ 20mA(mcd) |      | Viewing angle<br>2θ 1/2<br>(deg) |
|-------------|----------|---------|----------------|-------------------------------|------------------------------|------------------------------|------|-----------------------------------|------|----------------------------------|
|             |          | Emitted | Lens           |                               |                              | Min.                         | Max. | Min.                              | Typ. |                                  |
| L8UG2040-PF | AlGaInP  | Green   | Green Diffused | 574                           | 20                           | 1.7                          | 2.6  | 65                                | 120  | 36                               |

Note : 1.The forward voltage data did not including ±0.1V testing tolerance.  
2. The luminous intensity data did not including ±15% testing tolerance.



### Typical Electro-Optical Characteristics Curve

#### 8UG CHIP

Fig.1 Forward current vs. Forward Voltage

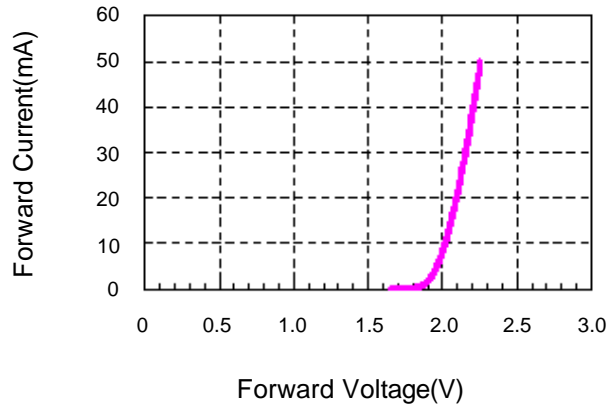

Fig.2 Relative Intensity vs. Forward Current

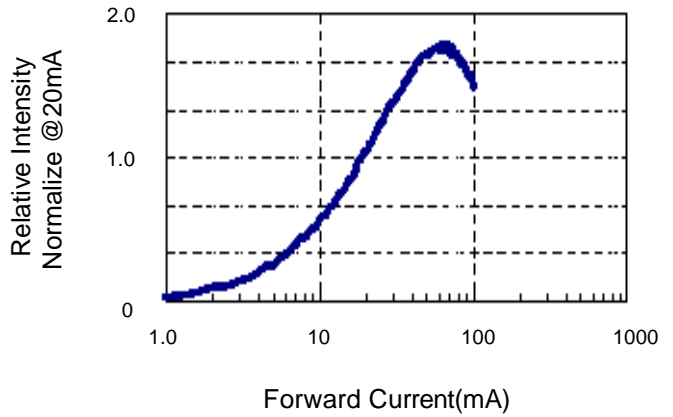

Fig.3 Forward Voltage vs. Temperature

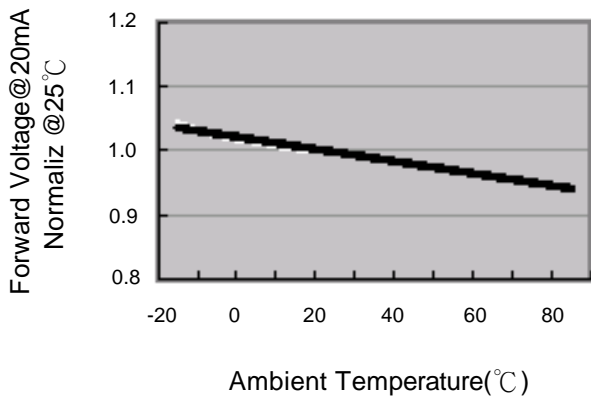

Fig.4 Relative Intensity vs. Temperature

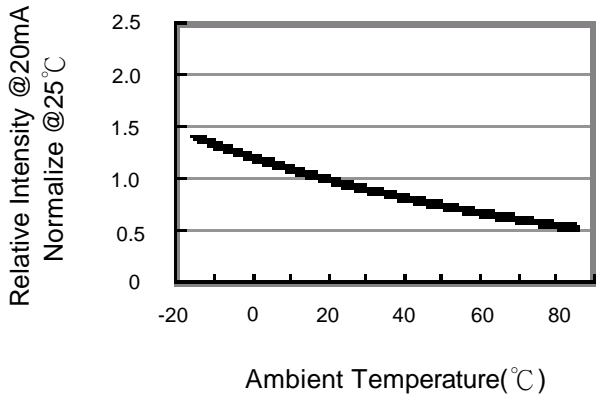
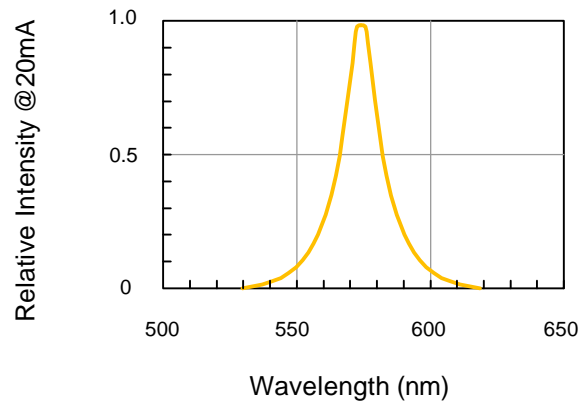

Fig.5 Relative Intensity vs. Wavelength





### Soldering Condition(Pb-Free)

#### 1.Iron:

- Soldering Iron:30W Max
- Temperature 350 °C Max
- Soldering Time:3 Seconds Max(One time only)
- Distance:2mm Min(From solder joint to body)

#### 2.Wave Soldering Profile

- Dip Soldering
- Preheat: 120° C Max
- Preheat time: 60seconds Max
- Ramp-up
- 2° C/sec(max)
- Ramp-Down:-5° C/sec(max)
- Solder Bath:260° C Max
- Dipping Time:3 seconds Max
- Distance:2mm Min(From solder joint to body)

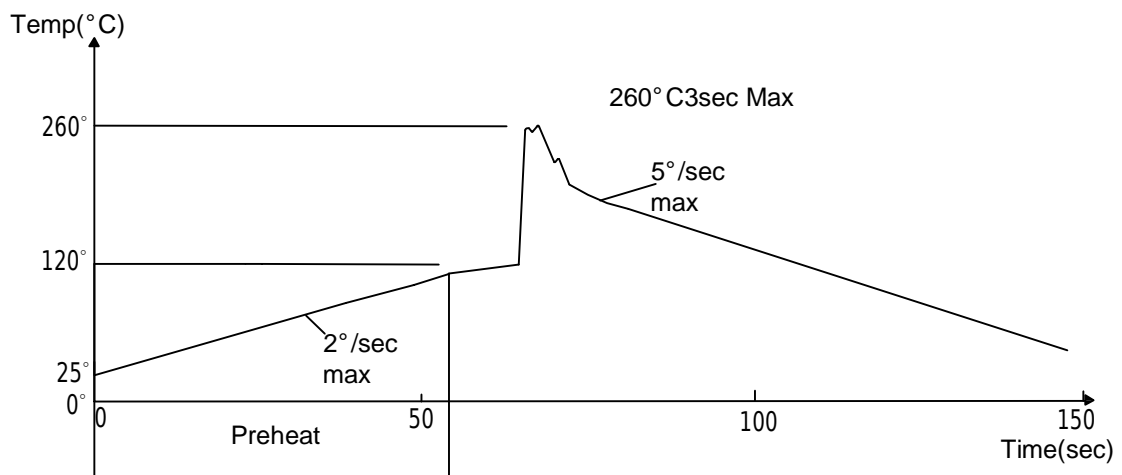

Note: 1.Wave solder should not be made more than one time.  
2.You can just only select one of the soldering conditions as above.

**Reliability Test:**

| Test Item                           | Test Condition   | Description   | Reference Standard   |
|-------------------------------------|--|---|--|
| Operating Life Test                 | 1.Under Room Temperature<br>2.If=20mA<br>3.t=1000 hrs (-24hrs, +72hrs) | This test is conducted for the purpose of detemining the resistance of a part in electrical and themal stressed.  | MIL-STD-750: 1026<br>MIL-STD-883: 1005<br>JIS C 7021: B-1                      |
| High Temperature Storage Test       | 1.Ta=105 °C ±5°C<br>2.t=1000 hrs (-24hrs, +72hrs)                      | The purpose of this is the resistance of the device which is laid under condition of high temperature for hours.  | MIL-STD-883:1008<br>JIS C 7021: B-10   |
| Low Temperature Storage Test        | 1.Ta=-40 °C ±5°C<br>2.t=1000 hrs (-24hrs, +72hrs)                      | The purpose of this is the resistance of the device which is laid under condition of low temperature for hours.   | JIS C 7021: B-12   |
| High Temperature High Humidity Test | 1.Ta=65 °C ±5°C<br>2.RH=90 %~95%<br>3.t=240hrs ±2hrs                   | The purpose of this test is the resistance of the device under tropical for hours.  | MIL-STD-202:103B<br>JIS C 7021: B-11   |
| Thermal Shock Test                  | 1.Ta=105 °C ±5°C & -40°C ±5°C (10min) (10min)<br>2.total 10 cycles     | The purpose of this is the resistance of the device to sudden extreme changes in high and low temperature.  | MIL-STD-202: 107D<br>MIL-STD-750: 1051<br>MIL-STD-883: 1011                    |
| Solder Resistance Test              | 1.T.Sol=260 °C ±5°C<br>2.Dwell time= 10 ±1sec.                         | This test intended to determine the thermal characteristic resistance of the device to sudden exposures at extreme changes in temperature when soldering the lead wire. | MIL-STD-202: 210A<br>MIL-STD-750: 2031<br>JIS C 7021: A-1                      |
| Solderability Test                  | 1.T.Sol=230 °C ±5°C<br>2.Dwell time=5 ±1sec                            | This test intended to see soldering well performed or not.  | MIL-STD-202: 208D<br>MIL-STD-750: 2026<br>MIL-STD-883: 2003<br>JIS C 7021: A-2 |