

# High Performance LVPECL Oscillator with Frequency Margining - Pin Control

## Features

- Low Jitter Crystal Oscillator (XO)
- Less than 1 ps Typical RMS Phase Jitter
- Differential LVPECL Output
- Output Frequency from 50 MHz to 690 MHz
- Two Frequency Margining Control Pins (FS0, FS1)
- Factory Configured or Field Programmable
- Integrated Phase-Locked Loop (PLL)
- Supply Voltage: 3.3 V or 2.5 V
- Pb-Free Package: 5.0 × 3.2 mm LCC
- Commercial and Industrial Temperature Ranges

## Functional Description

The CY2XF34 is a high performance and high frequency Crystal Oscillator (XO). It uses a Cypress proprietary low noise PLL to synthesize the frequency from an integrated crystal. The output frequency can be changed through two select pins, allowing easy frequency margin testing in applications.

The CY2XF34 is available as a factory configured device or as a field programmable device.

## Logic Block Diagram

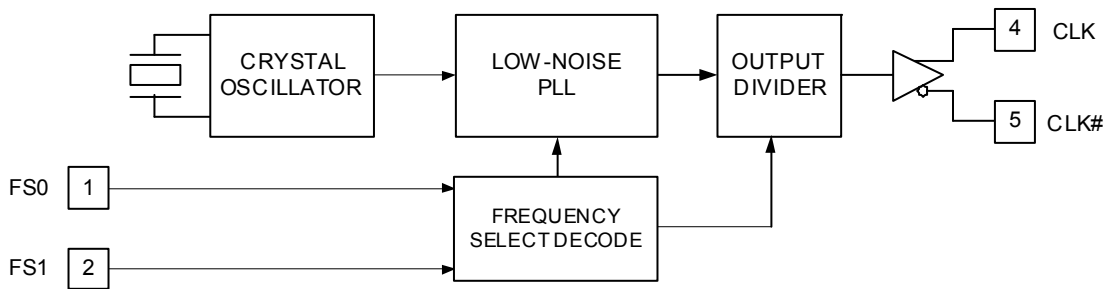

## Pinouts

**Figure 1. Pin Diagram - 6-pin Ceramic LCC**

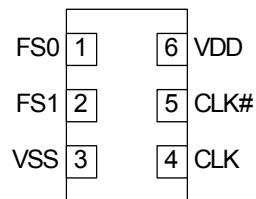

## Pin Definitions

| Pin  | Name      | I/O Type      | Description                    |
|------|-----------|---------------|--------------------------------|
| 1, 2 | FS0, FS1  | CMOS Input    | Frequency Select               |
| 4, 5 | CLK, CLK# | LVPECL Output | Differential Output Clock      |
| 6    | VDD       | Power         | Supply Voltage: 2.5 V or 3.3 V |
| 3    | VSS       | Power         | Ground                         |

## Functional Description

The FS0 and FS1 pins select between four different output frequencies, as shown in Table 1. Frequency margining is a common application for this feature. One frequency is used for the standard operating mode of the device, while the other frequencies are available for margin testing, either during product development or in system manufacturing test.

**Table 1. Frequency Select**

| FS1 | FS0 | Output Frequency |
|-----|-----|------------------|
| 0   | 0   | Frequency 0      |
| 0   | 1   | Frequency 1      |
| 1   | 0   | Frequency 2      |
| 1   | 1   | Frequency 3      |

When changing the output frequency, the frequency transition is not guaranteed to be smooth. There can be frequency excursions beyond the start frequency and the new frequency. Glitches and runt pulses are possible, and time must be allowed for the PLL to relock.

## Programming Description

The CY2XF34 is a programmable device. Before being used in an application, it must be programmed with the output frequencies and other variables described in a later section. Two different device types are available, each with its own programming flow. They are described in the following sections.

### Field Programmable CY2XF34F

Field programmable devices are shipped unprogrammed and must be programmed before being installed on a printed circuit board (PCB). Customers use CyberClocks™ Online Software to specify the device configuration and generate a JEDEC (extension .jed) programming file. Programming of samples and prototype quantities is available using a Cypress programmer. Third party vendors manufacture programmers for small to large volume applications. Cypress's value added distribution partners also provide programming services. Field programmable devices are designated with an "F" in the part number. They are intended for quick prototyping and inventory reduction. The CY2XF34 is One Time Programmable (OTP).

The software is located at [www.cyberclocksonline.com](http://www.cyberclocksonline.com).

## Factory Configured CY2XF34

For customers wanting ready-to-use devices, the CY2XF34 is available with no field programming required. All requests are submitted to the local Cypress Field Application Engineer (FAE) or sales representative. After the request is processed, you receive a new part number, samples, and datasheet with the programmed values. This part number is used for additional sample requests and production orders.

## Programming Variables

### Output Frequencies

The CY2XF34 is programmed with up to four independent output frequencies, which are then selected using the FS0 and FS1 pins. The device can synthesize frequencies to a resolution of 1 part per million (ppm), but the actual accuracy of the output frequency is limited by the accuracy of the integrated reference crystal.

The CY2XF34 has an output frequency range of 50 MHz to 690 MHz, but the range is not continuous. The CY2XF34 cannot generate frequencies in the ranges of 521 MHz to 529 MHz, and 596 MHz to 617 MHz.

### Industrial Versus Commercial Device Performance

Industrial and Commercial devices have different internal crystals. This has a potentially significant impact on performance levels for applications requiring the lowest possible phase noise. CyberClocks Online Software displays expected performance for both options.

### Phase Noise Versus Jitter Performance

In most cases, the device configuration for optimal phase noise performance is different from the device configuration for optimal cycle to cycle or period jitter. CyberClocks Online Software includes algorithms to optimize performance for either parameter.

**Table 2. Device Programming Variables**

| Variable                                     |
|--|
| Output Frequency 0 (Power on default)        |
| Output Frequency 1                           |
| Output Frequency 2                           |
| Output Frequency 3                           |
| Optimization (phase noise or jitter)         |
| Temperature range (Commercial or Industrial) |

## Absolute Maximum Conditions

| Parameter                      | Description                             | Condition                   | Min  | Max                   | Unit |
|--------------------------------|---|-----------------------------|------|-----------------------|------|
| V <sub>DD</sub>                | Supply Voltage                          |                             | -0.5 | 4.4                   | V    |
| V <sub>IN</sub> <sup>[1]</sup> | Input Voltage, DC                       | Relative to V <sub>SS</sub> | -0.5 | V <sub>DD</sub> + 0.5 | V    |
| T <sub>S</sub>                 | Temperature, Storage                    | Non Operating               | -55  | 135                   | °C   |
| T <sub>J</sub>                 | Temperature, Junction                   |                             | -40  | 135                   | °C   |
| ESD <sub>HBM</sub>             | ESD Protection (Human Body Model)       | JEDEC STD 22-A114-B         | 2000 | -                     | V    |
| Θ <sub>JA</sub> <sup>[2]</sup> | Thermal Resistance, Junction to Ambient | 0 m/s airflow               |      | 64                    | °C/W |

## Operating Conditions

| Parameter       | Description  | Min   | Typ | Max   | Unit |
|-----------------|--|-------|-----|-------|------|
| V <sub>DD</sub> | 3.3 V Supply Voltage Range   | 3.135 | 3.3 | 3.465 | V    |
|                 | 2.5 V Supply Voltage Range   | 2.375 | 2.5 | 2.625 | V    |
| T <sub>PU</sub> | Power Up Time for V <sub>DD</sub> to Reach Minimum Specified Voltage (Power Ramp is Monotonic) | 0.05  | -   | 500   | ms   |
| T <sub>A</sub>  | Ambient Temperature (Commercial)   | 0     | -   | 70    | °C   |
|                 | Ambient Temperature (Industrial)   | -40   | -   | 85    | °C   |

## DC Electrical Characteristics

| Parameter                      | Description  | Condition   | Min                    | Typ | Max                     | Unit |
|--------------------------------|--|---|------------------------|-----|-------------------------|------|
| I <sub>DD</sub> <sup>[3]</sup> | Operating Supply Current   | V <sub>DD</sub> = 3.465 V, CLK = 150 MHz, output terminated                           | -                      | -   | 150                     | mA   |
|                                |  | V <sub>DD</sub> = 2.625 V, CLK = 150 MHz, output terminated                           | -                      | -   | 145                     | mA   |
| V <sub>OH</sub>                | LVPECL High Output Voltage   | V <sub>DD</sub> = 3.3 V or 2.5 V, R <sub>TERM</sub> = 50 Ω to V <sub>DD</sub> - 2.0 V | V <sub>DD</sub> - 1.15 | -   | V <sub>DD</sub> - 0.75  | V    |
| V <sub>OL</sub>                | LVPECL Low Output Voltage  | V <sub>DD</sub> = 3.3 V or 2.5 V, R <sub>TERM</sub> = 50 Ω to V <sub>DD</sub> - 2.0 V | V <sub>DD</sub> - 2.0  | -   | V <sub>DD</sub> - 1.625 | V    |
| V <sub>OD1</sub>               | LVPECL Output Voltage Swing (V <sub>OH</sub> - V <sub>OL</sub> )           | V <sub>DD</sub> = 3.3 V or 2.5 V, R <sub>TERM</sub> = 50 Ω to V <sub>DD</sub> - 2.0 V | 600                    | -   | 1000                    | mV   |
| V <sub>OD2</sub>               | LVPECL Output Voltage Swing (V <sub>OH</sub> - V <sub>OL</sub> )           | V <sub>DD</sub> = 2.5 V, R <sub>TERM</sub> = 50 Ω to V <sub>DD</sub> - 1.5 V          | 500                    | -   | 1000                    | mV   |
| V <sub>OCM</sub>               | LVPECL Output Common Mode Voltage ((V <sub>OH</sub> + V <sub>OL</sub> )/2) | V <sub>DD</sub> = 2.5 V, R <sub>TERM</sub> = 50 Ω to V <sub>DD</sub> - 1.5 V          | 1.2                    | -   | -                       | V    |
| V <sub>IH</sub>                | Input High Voltage   |   | 0.7 × V <sub>DD</sub>  | -   | -                       | V    |
| V <sub>IL</sub>                | Input Low Voltage  |   | -                      | -   | 0.3 × V <sub>DD</sub>   | V    |
| I <sub>IH0</sub>               | Input High Current, FS0 pin  | Input = V <sub>DD</sub>   | -                      | -   | 115                     | μA   |
| I <sub>IH1</sub>               | Input High Current, FS1 pin  | Input = V <sub>DD</sub>   | -                      | -   | 10                      | μA   |
| I <sub>IL0</sub>               | Input Low Current, FS0 pin   | Input = V <sub>SS</sub>   | -50                    | -   | -                       | μA   |
| I <sub>IL1</sub>               | Input Low Current, FS1 pin   | Input = V <sub>SS</sub>   | -20                    | -   | -                       | μA   |

### Notes

- The voltage on any input or IO pin cannot exceed the power pin during power up.
- Simulated. The board is derived from the JEDEC multilayer standard. It measures 76 × 114 × 1.6 mm and has 4-layers of copper (2/1/1/2 oz.). The internal layers are 100% copper planes, while the top and bottom layers have 50% metalization. No vias are included in the model.
- I<sub>DD</sub> includes ~24 mA of current that is dissipated externally in the output termination resistors.

**DC Electrical Characteristics** (continued)

| Parameter                       | Description                | Condition | Min | Typ | Max | Unit |
|---------------------------------|----------------------------|-----------|-----|-----|-----|------|
| C <sub>IN0</sub> <sup>[4]</sup> | Input Capacitance, FS0 pin |           | –   | 15  | –   | pF   |
| C <sub>IN1</sub> <sup>[4]</sup> | Input Capacitance, FS1 pin |           | –   | 4   | –   | pF   |

**AC Electrical Characteristics**

The AC Electrical Characteristics for part CY2XF34 are as follows <sup>[4]</sup>

| Parameter                       | Description  | Condition   | Min | Typ | Max | Unit |
|---------------------------------|--|---|-----|-----|-----|------|
| F <sub>OUT</sub>                | Output Frequency <sup>[5]</sup>                        |   | 50  | –   | 690 | MHz  |
| FSC                             | Frequency Stability, commercial devices <sup>[6]</sup> | T <sub>A</sub> = 0 °C to 70 °C  | –   | –   | ±35 | ppm  |
| FSI                             | Frequency Stability, industrial devices <sup>[6]</sup> | T <sub>A</sub> = –40 °C to 85 °C  | –   | –   | ±55 | ppm  |
| AG                              | Aging, 10 years  |   | –   | –   | ±15 | ppm  |
| T <sub>DC</sub>                 | Output Duty Cycle                                      | F ≤ 450 MHz, measured at zero crossing  | 45  | 50  | 55  | %    |
|                                 |  | F > 450 MHz, measured at zero crossing  | 40  | 50  | 60  | %    |
| T <sub>R</sub> , T <sub>F</sub> | Output Rise and Fall Time                              | 20% and 80% of full output swing  | 0.2 | 0.4 | 1.0 | ns   |
| T <sub>LOCK</sub>               | Startup Time   | Time for CLK to reach valid frequency measured from the time V <sub>DD</sub> = V <sub>DD(min)</sub> | –   | –   | 10  | ms   |
| T <sub>LFS</sub>                | Re-lock Time   | Time for CLK to reach valid frequency from FS0 or FS1 pin change                                    | –   | –   | 10  | ms   |
| T <sub>Jitter(φ)</sub>          | RMS Phase Jitter (Random)                              | f <sub>OUT</sub> = 106.25 MHz (12 kHz–20 MHz)   | –   | 1   | –   | ps   |

**Typical Output Characteristics**

Figure 2. 2.5V Supply and Termination to V<sub>DD</sub>–1.5 V, minimum V<sub>DD</sub> and maximum T<sub>A</sub>

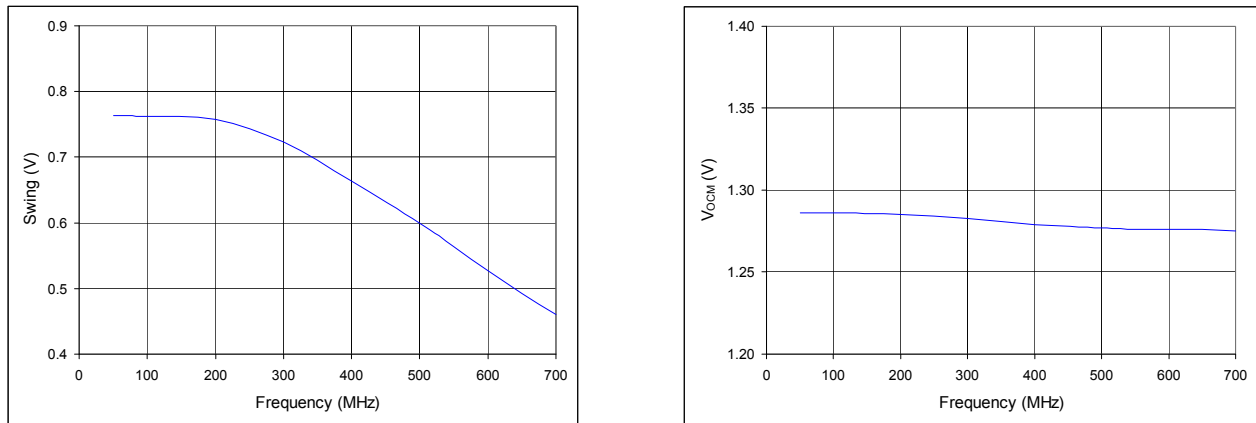

**Notes**

- 4. Not 100% tested, guaranteed by design and characterization.
- 5. This parameter is specified in CyberClocks Online software.
- 6. Frequency stability is the maximum variation in frequency from F<sub>0</sub>. It includes initial accuracy, plus variation from temperature and supply voltage.

**Figure 3. 2.5 V Supply and Termination to  $V_{DD}$ -2 V, minimum  $V_{DD}$  and maximum  $T_A$**

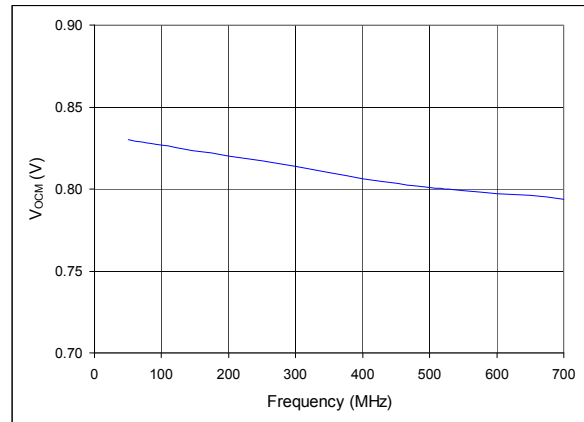
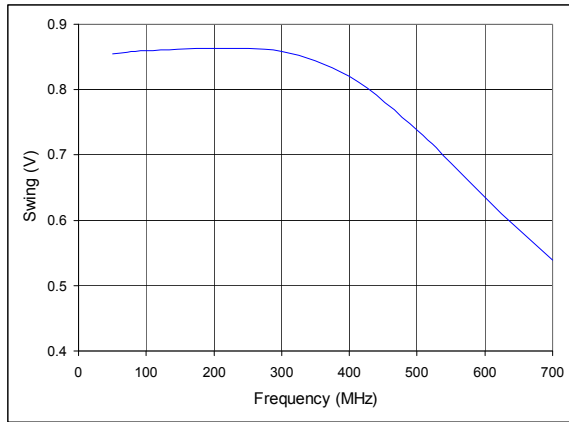

**Figure 4. 3.3 V Supply and Termination to  $V_{DD}$ -2 V, minimum  $V_{DD}$  and maximum  $T_A$**

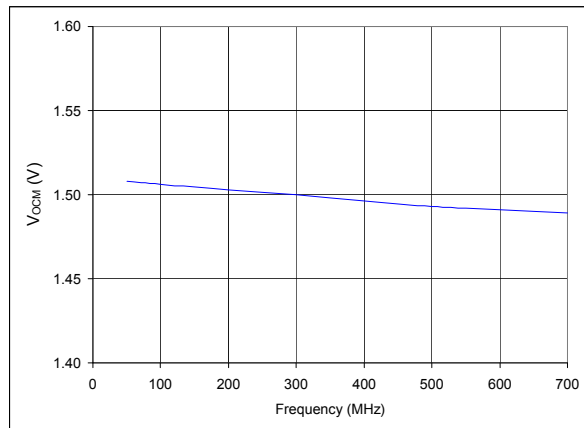
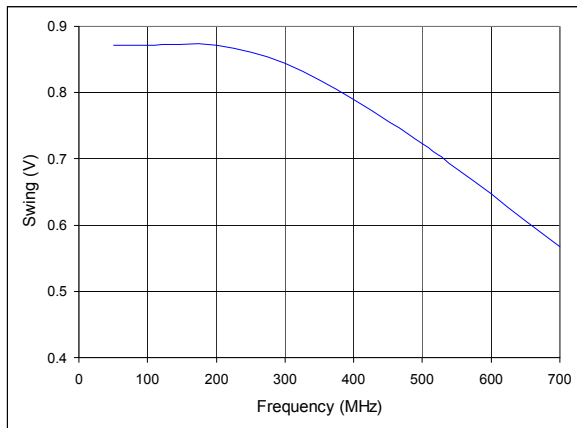

## Switching Waveforms

Figure 5. Output DC Parameters

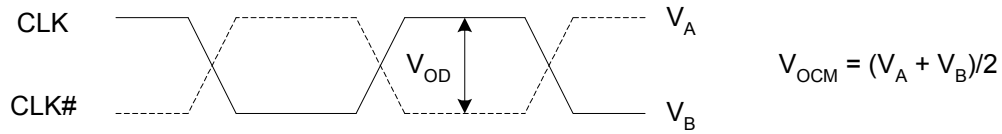

Figure 6. Duty Cycle Timing

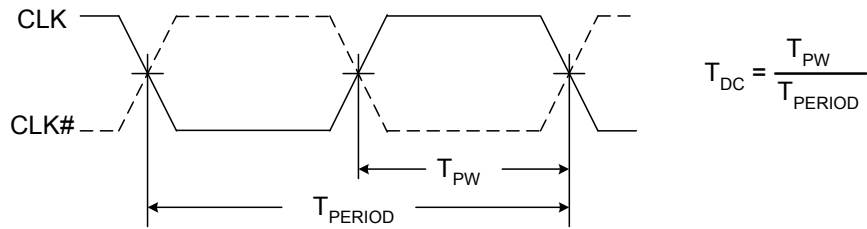
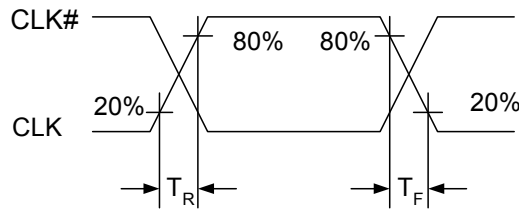
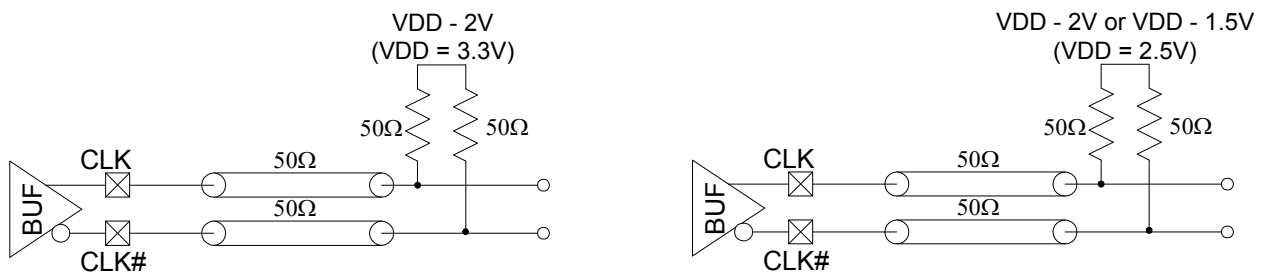

Figure 7. Output Rise and Fall Time



## Termination Circuits

Figure 8. LVPECL Termination



## Ordering Information

| Part Number    | Configuration      | Package Description                   | Product Flow                |
|----------------|--------------------|---------------------------------------|-----------------------------|
| <b>Pb-Free</b> |                    |                                       |                             |
| CY2XF34FLXCT   | Field Programmable | 6-pin Ceramic LCC SMD - Tape and Reel | Commercial, 0 °C to 70 °C   |
| CY2XF34FLXIT   | Field Programmable | 6-pin Ceramic LCC SMD - Tape and Reel | Industrial, -40 °C to 85 °C |

## Possible Configurations

Some product offerings are factory programmed customer specific devices with customized part numbers. The Possible Configurations table shows the available device types, but not complete part numbers. Contact your local Cypress FAE or Sales Representative for more information.

| Part Number <sup>[7]</sup> | Configuration      | Package Description                   | Product Flow                |
|----------------------------|--------------------|---------------------------------------|-----------------------------|
| <b>Pb-Free</b>             |                    |                                       |                             |
| CY2XF34LXCxxxT             | Factory Configured | 6-pin Ceramic LCC SMD - Tape and Reel | Commercial, 0 °C to 70 °C   |
| CY2XF34LXIxxxT             | Factory Configured | 6-pin Ceramic LCC SMD - Tape and Reel | Industrial, -40 °C to 85 °C |

## Ordering Code Definitions

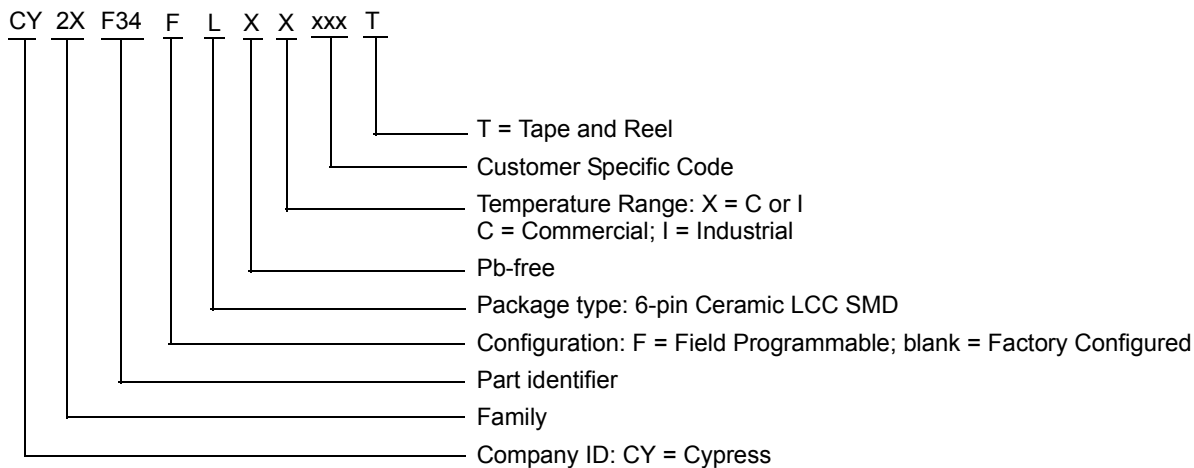

### Note

7. "xxx" is a factory assigned code that identifies the programming option. For more details, contact your local Cypress FAE or Sales Representative.

Package Drawings and Dimensions

Figure 9. 6-pin 3.2 × 5.0 mm Ceramic LCC LZ06A

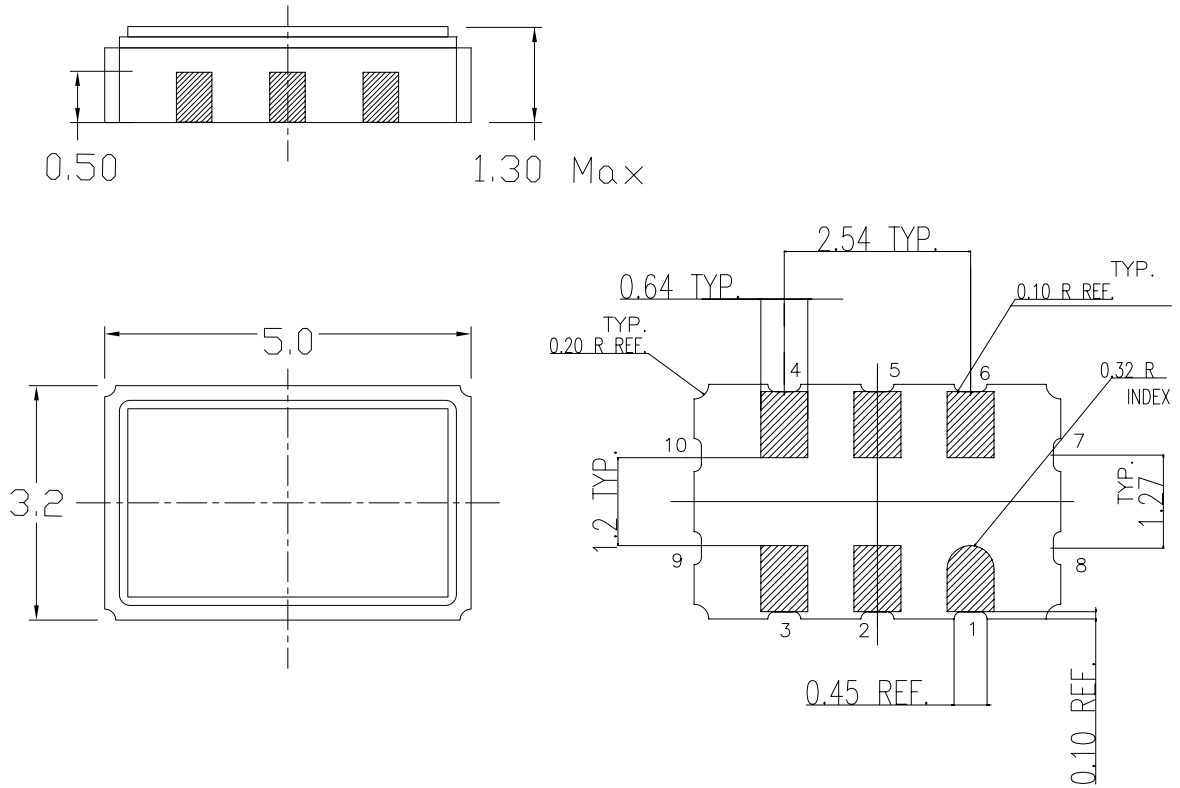

Dimensions in mm  
 General Tolerance: ± 0.15MM  
 Kyocera dwg ref KD-VA6432-A  
 Package Weight ~ 0.12 grams

001-10044 \*A



## Acronyms

| Acronym | Description                             |
|---------|---|
| CMOS    | complementary metal oxide semiconductor |
| ESD     | electrostatic discharge                 |
| FAE     | Field Application Engineer              |
| I/O     | input/output                            |
| OTP     | One Time Programmable                   |
| PCB     | printed circuit board                   |
| PLL     | phase-locked loop                       |
| SMD     | Surface Mounted Devices                 |

## Document Conventions

### Units of Measure

| Symbol | Unit of Measure   |
|--------|-------------------|
| °C     | degree Celsius    |
| μA     | micro Amperes     |
| mA     | milli Amperes     |
| mm     | milli meter       |
| ms     | milli seconds     |
| mV     | milli Volts       |
| MHz    | Mega Hertz        |
| ns     | nano seconds      |
| pF     | pico Farad        |
| ps     | pico seconds      |
| ppm    | parts per million |
| V      | Volts             |
| W      | Watts             |
| %      | percent           |
| Ω      | ohms              |

## Document History Page

| Document Title: CY2XF34 High Performance LVPECL Oscillator with Frequency Margining - Pin Control |         |                 |                 |   |
|---|---------|-----------------|-----------------|---|
| Document Number: 001-53149  |         |                 |                 |   |
| Revision  | ECN     | Orig. of Change | Submission Date | Description of Change   |
| **  | 2704379 | KVM/PYRS        | 05/11/09        | New datasheet   |
| *A  | 2734005 | WWZ             | 07/09/09        | Post to external web  |
| *B  | 2761926 | KVM             | 09/10/09        | Revised maximum output rise and fall times<br>Added Absolute Maximum Conditions table   |
| *C  | 2898472 | KVM             | 03/24/2010      | Moved 'xxx' parts to Possible Configurations table.<br>Updated package diagram.   |
| *D  | 3199911 | BASH            | 03/18/2011      | Changed status from Preliminary to Final.<br>Added <a href="#">Ordering Code Definitions</a> .<br>Added <a href="#">Acronyms</a> and <a href="#">Units of Measure</a> .<br>Updated in new template. |

## Sales, Solutions, and Legal Information

### Worldwide Sales and Design Support

Cypress maintains a worldwide network of offices, solution centers, manufacturer’s representatives, and distributors. To find the office closest to you, visit us at [cypress.com/sales](http://cypress.com/sales).

### Products

- Automotive [cypress.com/go/automotive](http://cypress.com/go/automotive)
- Clocks & Buffers [cypress.com/go/clocks](http://cypress.com/go/clocks)
- Interface [cypress.com/go/interface](http://cypress.com/go/interface)
- Lighting & Power Control [cypress.com/go/powerpsoc](http://cypress.com/go/powerpsoc)  
[cypress.com/go/plc](http://cypress.com/go/plc)
- Memory [cypress.com/go/memory](http://cypress.com/go/memory)
- Optical & Image Sensing [cypress.com/go/image](http://cypress.com/go/image)
- PSoC [cypress.com/go/psoc](http://cypress.com/go/psoc)
- Touch Sensing [cypress.com/go/touch](http://cypress.com/go/touch)
- USB Controllers [cypress.com/go/USB](http://cypress.com/go/USB)
- Wireless/RF [cypress.com/go/wireless](http://cypress.com/go/wireless)

### PSoC Solutions

- [psoc.cypress.com/solutions](http://psoc.cypress.com/solutions)
- PSoC 1 | PSoC 3 | PSoC 5

© Cypress Semiconductor Corporation, 2009-2011. The information contained herein is subject to change without notice. Cypress Semiconductor Corporation assumes no responsibility for the use of any circuitry other than circuitry embodied in a Cypress product. Nor does it convey or imply any license under patent or other rights. Cypress products are not warranted nor intended to be used for medical, life support, life saving, critical control or safety applications, unless pursuant to an express written agreement with Cypress. Furthermore, Cypress does not authorize its products for use as critical components in life-support systems where a malfunction or failure may reasonably be expected to result in significant injury to the user. The inclusion of Cypress products in life-support systems application implies that the manufacturer assumes all risk of such use and in doing so indemnifies Cypress against all charges.

Any Source Code (software and/or firmware) is owned by Cypress Semiconductor Corporation (Cypress) and is protected by and subject to worldwide patent protection (United States and foreign), United States copyright laws and international treaty provisions. Cypress hereby grants to licensee a personal, non-exclusive, non-transferable license to copy, use, modify, create derivative works of, and compile the Cypress Source Code and derivative works for the sole purpose of creating custom software and or firmware in support of licensee product to be used only in conjunction with a Cypress integrated circuit as specified in the applicable agreement. Any reproduction, modification, translation, compilation, or representation of this Source Code except as specified above is prohibited without the express written permission of Cypress.

Disclaimer: CYPRESS MAKES NO WARRANTY OF ANY KIND, EXPRESS OR IMPLIED, WITH REGARD TO THIS MATERIAL, INCLUDING, BUT NOT LIMITED TO, THE IMPLIED WARRANTIES OF MERCHANTABILITY AND FITNESS FOR A PARTICULAR PURPOSE. Cypress reserves the right to make changes without further notice to the materials described herein. Cypress does not assume any liability arising out of the application or use of any product or circuit described herein. Cypress does not authorize its products for use as critical components in life-support systems where a malfunction or failure may reasonably be expected to result in significant injury to the user. The inclusion of Cypress’ product in a life-support systems application implies that the manufacturer assumes all risk of such use and in doing so indemnifies Cypress against all charges.

Use may be limited by and subject to the applicable Cypress software license agreement.