

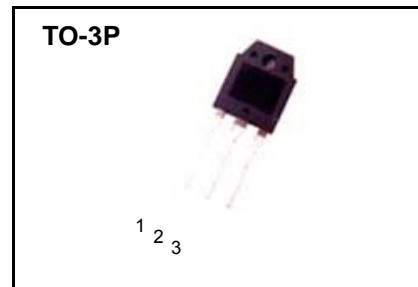
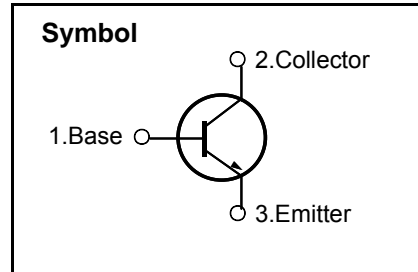
## High Voltage Fast-Switching NPN Power Transistor

### Features

- Very High Switching Speed
- Minimum Lot-to-Lot hFE Variation
- Wide Reverse Bias S.O.A

### General Description

This device is designed for high voltage, high speed switching characteristic required such as lighting system, switching mode power supply.



### Absolute Maximum Ratings

Symbol	Parameter	Value	Units
$V_{CES}$	Collector-Emitter Voltage ( $V_{BE} = 0$ )	700	V
$V_{CEO}$	Collector-Emitter Voltage ( $I_B = 0$ )	400	V
$V_{EBO}$	Emitter-Base Voltage ( $I_C = 0$ )	9.0	V
$I_C$	Collector Current	12.0	A
$I_{CP}$	Collector Pulse Current	24.0	A
$I_B$	Base Current	6.0	A
$I_{BM}$	Base Peak Current ( $t_p < 5$ ms )	12.0	A
$P_C$	Total Dissipation at $T_C = 25$ °C	130	W
$T_{STG}$	Storage Temperature	- 65 ~ 150	°C
$T_J$	Max. Operating Junction Temperature	150	°C

### Thermal Characteristics

Symbol	Parameter	Value	Units
$R_{\theta JC}$	Thermal Resistance, Junction-to-Case	1.67	°C/W
$R_{\theta JA}$	Thermal Resistance, Junction-to-Ambient	62.5	°C/W

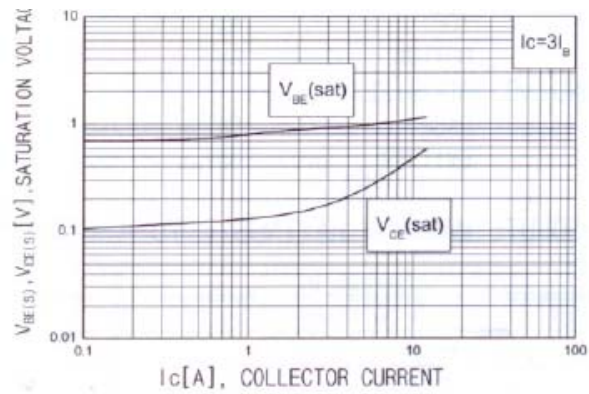
# SBW13009-O

## Electrical Characteristics ( $T_C = 25\text{ }^\circ\text{C}$ unless otherwise noted )

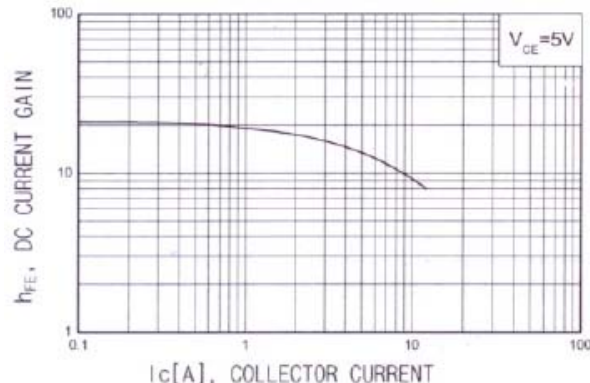
Symbol	Parameter	Condition	Min	Typ	Max	Units
$I_{CEV}$	Collector Cut-off Current ( $V_{BE} = -1.5V$ )	$V_{CE} = 700V$ $V_{CE} = 700V$ $T_C = 100\text{ }^\circ\text{C}$	-	-	1.0 5.0	mA
$V_{CEO(sus)}$	Collector-Emitter Sustaining Voltage ( $I_B = 0$ )	$I_C = 10\text{ mA}$	400	-	-	V
$V_{CE(sat)}$	Collector-Emitter Saturation Voltage	$I_C = 5.0A$ $I_B = 1.0A$ $I_C = 8.0A$ $I_B = 1.6A$ $I_C = 12.0A$ $I_B = 3.0A$	-	-	0.5 0.6 1.0	V
$V_{BE(sat)}$	Base-Emitter Saturation Voltage	$I_C = 5.0A$ $I_B = 1.0A$ $I_C = 8.0A$ $I_B = 1.6A$	-	-	1.2 1.6	V
$h_{FE}^*$	DC Current Gain	$I_C = 5.0A$ $V_{CE} = 5V$ $I_C = 8.0A$ $V_{CE} = 5V$	15 5	-	30 30	
$t_s$ $t_f$	Storage Time Fall Time	$I_C = 8.0A$ $V_{CC} = 125V$ $I_{B1} = 1.6A$ $I_{B2} = -1.6A$ $T_P = 25\mu s$	-		3.0 0.7	$\mu s$



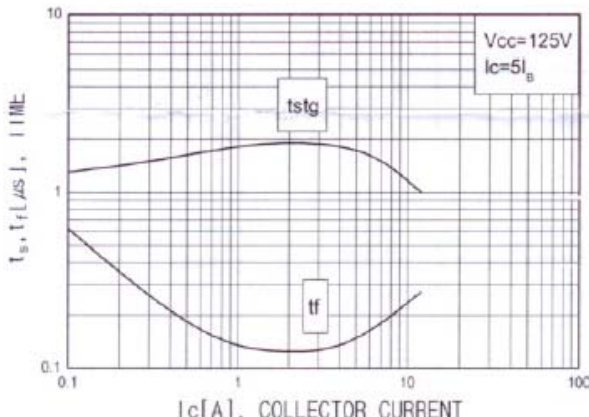
**Fig 1. Saturation voltage**



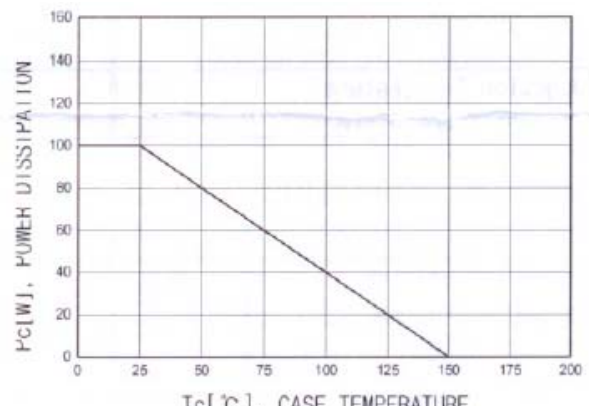
**Fig 2. DC Current Gain**



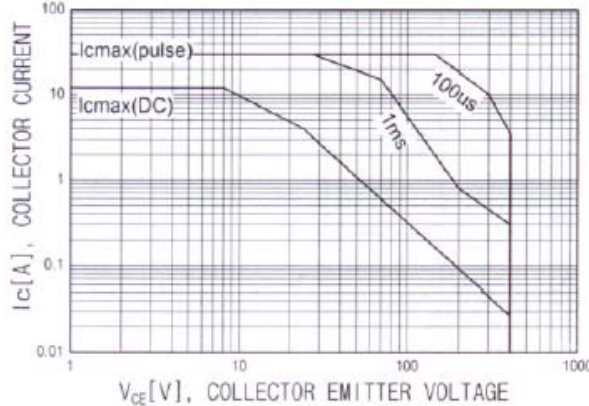
**Fig 3. Switching Time**



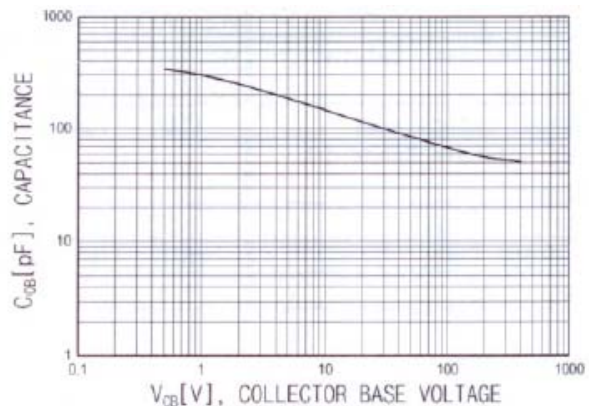
**Fig 4. Power Derating**



**Fig 5. Safe operation area**

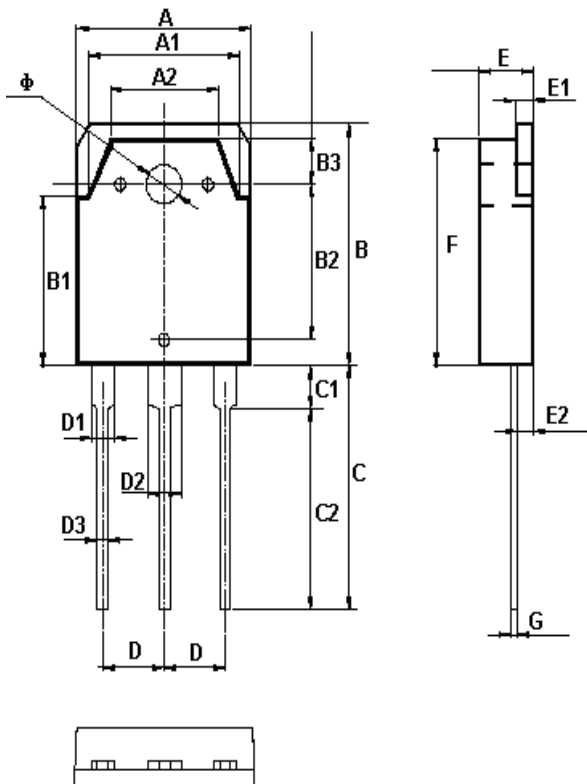


**Fig 6. Collect output capacitance**



# SBW13009-O

## TO-3P Dimension



corresponding symbol	measurement	
A(mm)	15.60±0.20	
A1(mm)	13.60±0.20	
A2(mm)dia.	9.60±0.20	
B(mm)	19.90±0.20	
B1(mm)	13.90±0.20	
B2(mm)	12.76±0.20	
B3(mm)	3.80±0.20	
C(mm)	20.00±0.30	
C1(mm)	3.50±0.20	
C2(mm)	16.50±0.30	
D(mm)	5.45(TYP)	
D1	2.0 ±0.20	
D2	3.0±0.20	
D3	1.00±0.20	
E(mm)	4.80±0.20	
E1(mm)	1.50±	+0.15 -0.05
E2(mm)	1.40±0.20	
F(mm)	18.70±0.20	
G(mm)	0.60	+0.15 -0.05
$\phi$ (mm)	3.20±0.10	

