

# NTHS5441T1

## Power MOSFET P-Channel ChipFET™

3.9 Amps, 20 Volts

### Features

- Low  $R_{DS(on)}$
- Higher Efficiency Extending Battery Life
- Logic Level Gate Drive
- Miniature ChipFET Surface Mount Package

### Applications

- Power Management in Portable and Battery-Powered Products; i.e., Cellular and Cordless Telephones and PCMCIA Cards

### MAXIMUM RATINGS ( $T_A = 25^\circ\text{C}$ unless otherwise noted)

Rating	Symbol	5 Secs	Steady State	Unit
Drain-Source Voltage	$V_{DS}$	-20		V
Gate-Source Voltage	$V_{GS}$	$\pm 12$		V
Continuous Drain Current ( $T_J = 150^\circ\text{C}$ ) (Note 1) $T_A = 25^\circ\text{C}$ $T_A = 85^\circ\text{C}$	$I_D$	$\pm 5.3$ $\pm 3.8$	$\pm 3.9$ $\pm 2.8$	A
Pulsed Drain Current	$I_{DM}$	$\pm 20$		A
Continuous Source Current (Note 1)	$I_S$	-2.1	-1.1	A
Maximum Power Dissipation (Note 1) $T_A = 25^\circ\text{C}$ $T_A = 85^\circ\text{C}$	$P_D$	2.5 1.3	1.3 0.7	W
Operating Junction and Storage Temperature Range	$T_J, T_{stg}$	-55 to +150		$^\circ\text{C}$

1. Surface Mounted on 1" x 1" FR4 Board.



ON Semiconductor®

<http://onsemi.com>

**3.9 AMPS**  
**20 VOLTS**  
 $R_{DS(on)} = 60 \text{ m}\Omega$

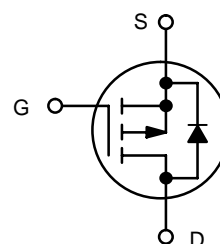

P-Channel MOSFET

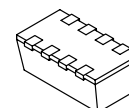

ChipFET  
CASE 1206A  
STYLE 1

### PIN CONNECTIONS

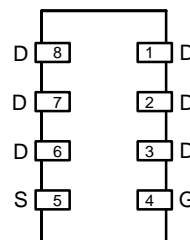

### MARKING DIAGRAM

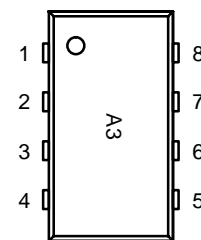

A3 = Specific Device Code

### ORDERING INFORMATION

Device	Package	Shipping
NTHS5441T1	ChipFET	3000/Tape & Reel

# NTHS5441T1

## THERMAL CHARACTERISTICS

Characteristic	Symbol	Typ	Max	Unit
Maximum Junction-to-Ambient (Note 2) $t \leq 5$ sec Steady State	$R_{thJA}$	40 80	50 95	$^{\circ}C/W$
Maximum Junction-to-Foot (Drain) Steady State	$R_{thJF}$	15	20	$^{\circ}C/W$

## ELECTRICAL CHARACTERISTICS ( $T_J = 25^{\circ}C$ unless otherwise noted)

Characteristic	Symbol	Test Condition	Min	Typ	Max	Unit
----------------	--------	----------------	-----	-----	-----	------

### Static

Gate Threshold Voltage	$V_{GS(th)}$	$V_{DS} = V_{GS}, I_D = -250 \mu A$	-0.6	-	1.2	V
Gate-Body Leakage	$I_{GSS}$	$V_{DS} = 0 V, V_{GS} = \pm 12 V$	-	-	$\pm 100$	nA
Zero Gate Voltage Drain Current	$I_{DSS}$	$V_{DS} = -16 V, V_{GS} = 0 V$	-	-	-1.0	$\mu A$
		$V_{DS} = -16 V, V_{GS} = 0 V,$ $T_J = 85^{\circ}C$	-	-	-5.0	
On-State Drain Current (Note 3)	$I_{D(on)}$	$V_{DS} \leq -5.0 V, V_{GS} = -4.5 V$	-20	-	-	A
Drain-Source On-State Resistance (Note 3)	$r_{DS(on)}$	$V_{GS} = -3.6 V, I_D = -3.7 A$ $V_{GS} = -4.5 V, I_D = -3.9 A$	-	0.050 0.046	0.06 -	$\Omega$
		$V_{GS} = -2.5 V, I_D = -3.1 A$	-	0.070	0.083	
Forward Transconductance (Note 3)	$g_{fs}$	$V_{DS} = -10 V, I_D = -3.9 A$	-	12	-	mhos
Diode Forward Voltage (Note 3)	$V_{SD}$	$I_S = -1.1 A, V_{GS} = 0 V$	-	-0.8	-1.2	V

### Dynamic (Note 4)

Total Gate Charge	$Q_g$	$V_{DS} = -10 V, V_{GS} = -4.5 V,$ $I_D = -3.9 A$	-	11	22	nC
Gate-Source Charge	$Q_{gs}$		-	3.0	-	
Gate-Drain Charge	$Q_{gd}$		-	2.5	-	
Input Capacitance	$C_{iss}$	$V_{DS} = -5.0 V_{dc}, V_{GS} = 0 V_{dc},$ $f = 1.0 MHz$	-	710	-	pF
Output Capacitance	$C_{oss}$		-	400	-	
Reverse Transfer Capacitance	$C_{rss}$		-	140	-	
Turn-On Delay Time	$t_{d(on)}$	$V_{DD} = -10 V, R_L = 10 \Omega$ $I_D \cong -1.0 A, V_{GEN} = -4.5 V,$ $R_G = 6 \Omega$	-	14	30	ns
Rise Time	$t_r$		-	22	55	
Turn-Off Delay Time	$t_{d(off)}$		-	42	100	
Fall Time	$t_f$		-	35	70	
Source-Drain Reverse Recovery Time	$t_{rr}$	$I_F = -1.1 A, di/dt = 100 A/\mu s$	-	30	60	

2. Surface Mounted on 1" x 1" FR4 Board.
3. Pulse Test: Pulse Width  $\leq 300 \mu s$ , Duty Cycle  $\leq 2\%$ .
4. Guaranteed by design, not subject to production testing.

TYPICAL ELECTRICAL CHARACTERISTICS

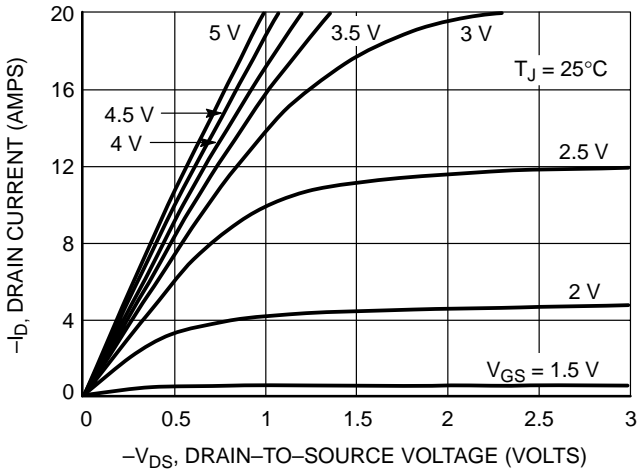

Figure 1. On-Region Characteristics

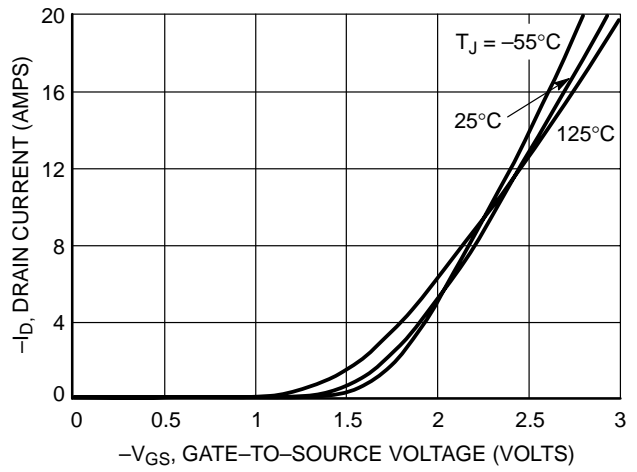

Figure 2. Transfer Characteristics

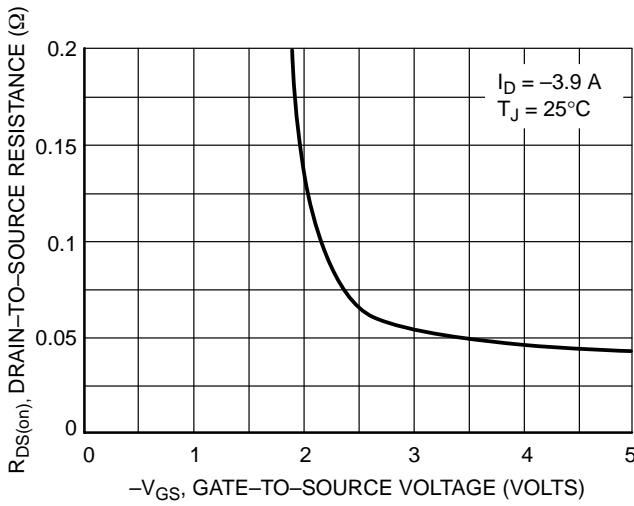

Figure 3. On-Resistance versus Gate-to-Source Voltage

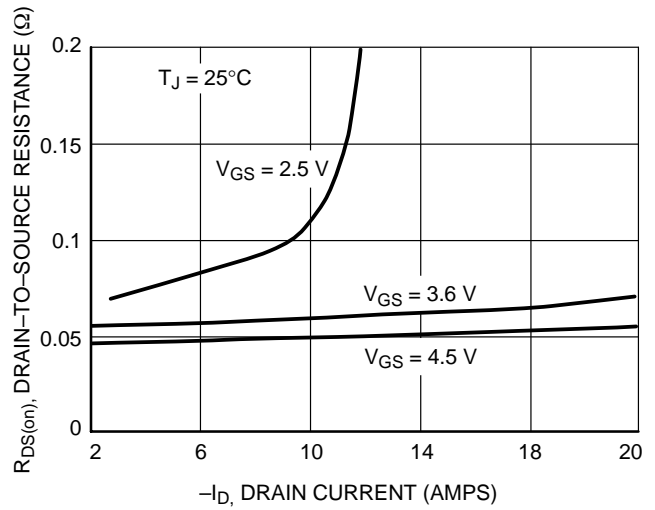

Figure 4. On-Resistance versus Drain Current and Gate Voltage

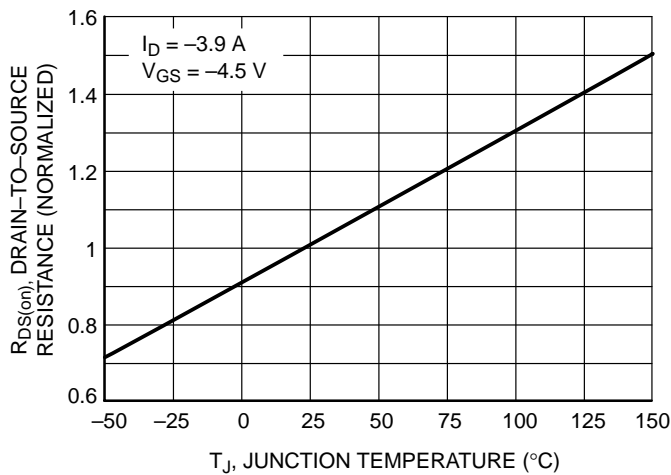

Figure 5. On-Resistance Variation with Temperature

# NTHS5441T1

## TYPICAL ELECTRICAL CHARACTERISTICS

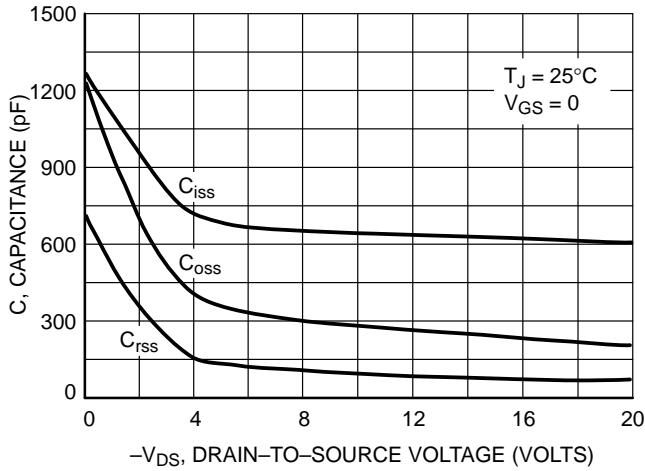

Figure 6. Capacitance Variation

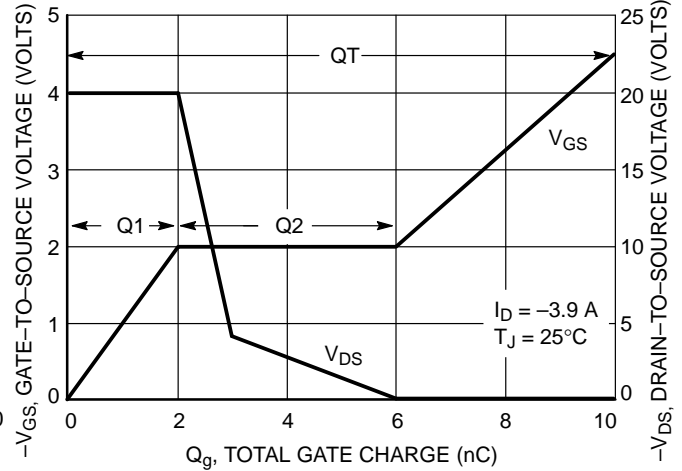

Figure 7. Gate-to-Source and Drain-to-Source Voltage versus Total Charge

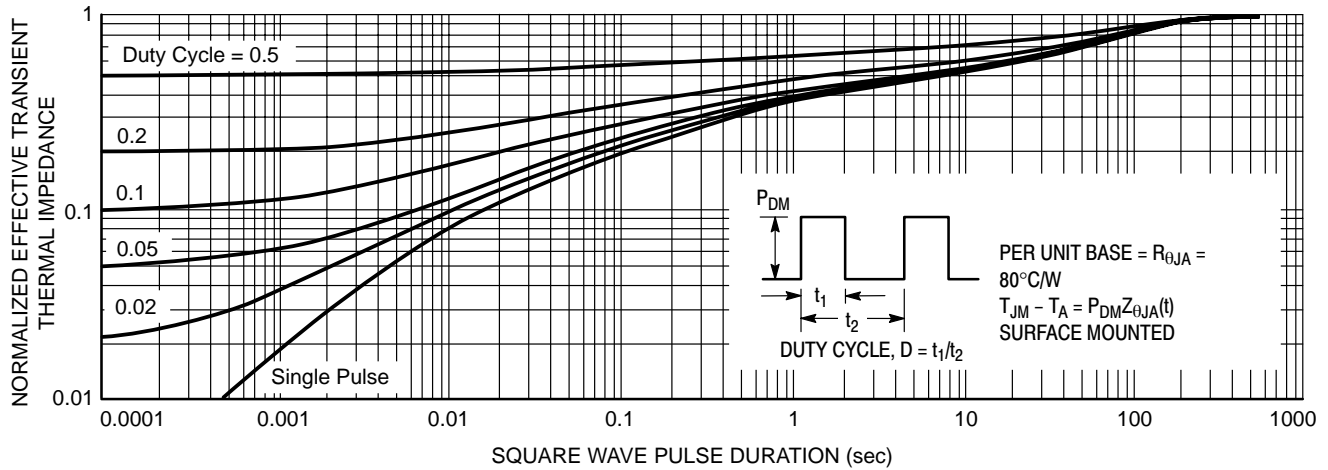

Figure 8. Normalized Thermal Transient Impedance, Junction-to-Ambient

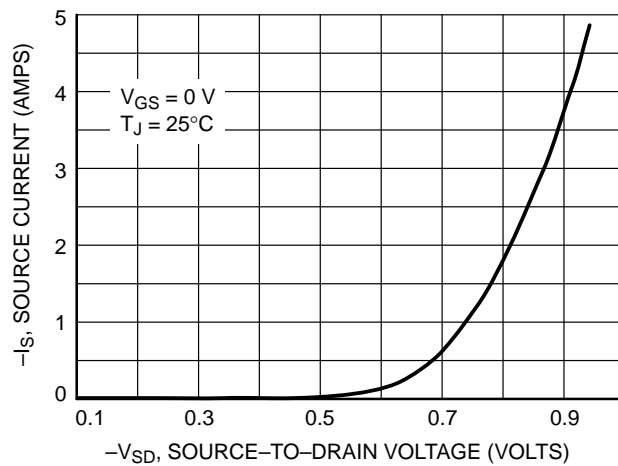

Figure 9. Diode Forward Voltage versus Current

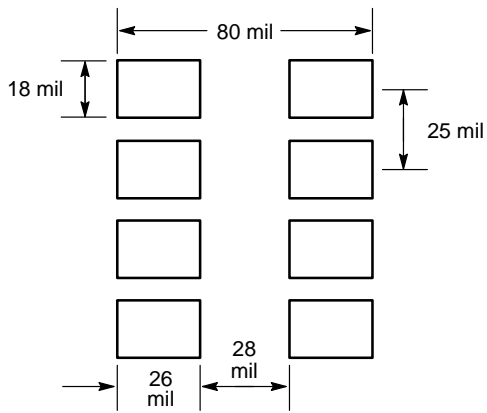

Figure 10.

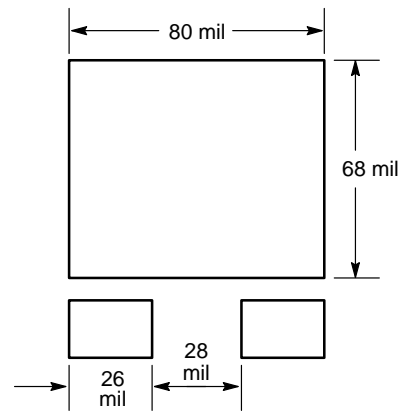

Figure 11.

**BASIC PAD PATTERNS**

The basic pad layout with dimensions is shown in Figure 11. This is sufficient for low power dissipation MOSFET applications, but power semiconductor performance requires a greater copper pad area, particularly for the drain leads.

The minimum recommended pad pattern shown in Figure 10 improves the thermal area of the drain connections (pins 1, 2, 3, 6, 7, 8) while remaining within the

confines of the basic footprint. The drain copper area is 0.0054 sq. in. (or 3.51 sq. mm). This will assist the power dissipation path away from the device (through the copper leadframe) and into the board and exterior chassis (if applicable) for the single device. The addition of a further copper area and/or the addition of vias to other board layers will enhance the performance still further.

# NTHS5441T1

## PACKAGE DIMENSIONS

ChipFET™  
CASE 1206A-03  
ISSUE D

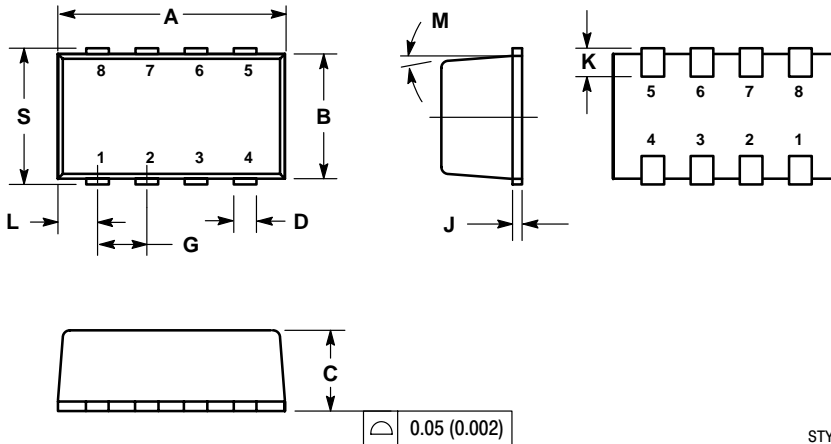

### NOTES:

1. DIMENSIONING AND TOLERANCING PER ANSI Y14.5M, 1982.
2. CONTROLLING DIMENSION: MILLIMETER.
3. MOLD GATE BURRS SHALL NOT EXCEED 0.13 MM PER SIDE.
4. LEADFRAME TO MOLDED BODY OFFSET IN HORIZONTAL AND VERTICAL SHALL NOT EXCEED 0.08 MM.
5. DIMENSIONS A AND B EXCLUSIVE OF MOLD GATE BURRS.
6. NO MOLD FLASH ALLOWED ON THE TOP AND BOTTOM LEAD SURFACE.
7. 1206A-01 AND 1206A-02 OBSOLETE. NEW STANDARD IS 1206A-03.

DIM	MILLIMETERS		INCHES	
	MIN	MAX	MIN	MAX
A	2.95	3.10	0.116	0.122
B	1.55	1.70	0.061	0.067
C	1.00	1.10	0.039	0.043
D	0.25	0.35	0.010	0.014
G	0.65 BSC		0.025 BSC	
J	0.10	0.20	0.004	0.008
K	0.28	0.42	0.011	0.017
L	0.55 BSC		0.022 BSC	
M	5° NOM		5° NOM	
S	1.80	2.00	0.072	0.080

STYLE 1:  
PIN 1. DRAIN  
2. DRAIN  
3. DRAIN  
4. GATE  
5. SOURCE  
6. DRAIN  
7. DRAIN  
8. DRAIN

**Notes**

ChipFET is a trademark of Vishay Siliconix

**ON Semiconductor** and  are registered trademarks of Semiconductor Components Industries, LLC (SCILLC). SCILLC reserves the right to make changes without further notice to any products herein. SCILLC makes no warranty, representation or guarantee regarding the suitability of its products for any particular purpose, nor does SCILLC assume any liability arising out of the application or use of any product or circuit, and specifically disclaims any and all liability, including without limitation special, consequential or incidental damages. "Typical" parameters which may be provided in SCILLC data sheets and/or specifications can and do vary in different applications and actual performance may vary over time. All operating parameters, including "Typicals" must be validated for each customer application by customer's technical experts. SCILLC does not convey any license under its patent rights nor the rights of others. SCILLC products are not designed, intended, or authorized for use as components in systems intended for surgical implant into the body, or other applications intended to support or sustain life, or for any other application in which the failure of the SCILLC product could create a situation where personal injury or death may occur. Should Buyer purchase or use SCILLC products for any such unintended or unauthorized application, Buyer shall indemnify and hold SCILLC and its officers, employees, subsidiaries, affiliates, and distributors harmless against all claims, costs, damages, and expenses, and reasonable attorney fees arising out of, directly or indirectly, any claim of personal injury or death associated with such unintended or unauthorized use, even if such claim alleges that SCILLC was negligent regarding the design or manufacture of the part. SCILLC is an Equal Opportunity/Affirmative Action Employer.

## PUBLICATION ORDERING INFORMATION

### Literature Fulfillment:

Literature Distribution Center for ON Semiconductor  
P.O. Box 5163, Denver, Colorado 80217 USA  
**Phone:** 303-675-2175 or 800-344-3860 Toll Free USA/Canada  
**Fax:** 303-675-2176 or 800-344-3867 Toll Free USA/Canada  
**Email:** ONlit@hibbertco.com

**N. American Technical Support:** 800-282-9855 Toll Free USA/Canada

**JAPAN:** ON Semiconductor, Japan Customer Focus Center  
2-9-1 Kamimeguro, Meguro-ku, Tokyo, Japan 153-0051  
**Phone:** 81-3-5773-3850  
**Email:** r14525@onsemi.com

**ON Semiconductor Website:** <http://onsemi.com>

For additional information, please contact your local Sales Representative.