

Preliminary



SF1218D

**453.5 MHz
SAW Filter**

- Low Insertion Loss
- 3.8 X 3.8 X 1.0 mm Surface Mount Case
- Single-ended Input and Output
- Complies with Directive 2002/95/EC (RoHS)



Absolute Maximum Ratings

Rating	Value	Units
Maximum Input Power	+27	dBm
Maximum DC Voltage Between any Two Terminals	3	VDC
Storage Temperature Range in Tape and Reel	-40 to +85	°C
Suitable for Lead-free Soldering - Maximum Soldering Profile	260 °C for 30 s	

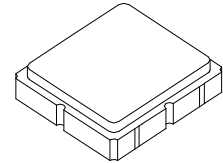

SM3838-6

Electrical Characteristics

Characteristic	Sym	Notes	Min	Typ	Max	Units
Center Frequency	f_c	1		453.5		MHz
Source Impedance, Single Ended				50		Ω
Load Impedance, Single Ended				50		Ω
Attenuation Referenced to 0 dB						dB
300 kHz to 350 MHz			30	33		
350 MHz to 445 MHz			25	30		
460 MHz to 462 MHz			6	20		
462 MHz to 467 MHz			25	35		
467 MHz to 2000 MHz			25	33		
Maximum Insertion Loss, 450 to 455 MHz	IL_{MAX}			1.7	3.0	dB
Amplitude Variation, 450 to 457 MHz				0.9	1.5	dB
Input Return Loss, 450 to 457 MHz			9	11		dB
Output Return Loss, 450 to 457 MHz			9	11		dB
Operating Temperature			-40		+85	°C

Case Style	SM3838-6 3.8 x 3.8 mm Nominal Footprint		
Lid Symbolization (Y=year, WW=week, S=shift) dot=pin 1 indicator	TBD, YWWS		
Standard Reel Quantity	Reel Size 7 Inch	1000 Pieces/Reel	
	Reel Size 13 Inch	3000 Pieces/Reel	



CAUTION: Electrostatic Sensitive Device. Observe precautions for handling.

Notes:

1. Unless noted otherwise, all specifications apply over the operating temperature range with filter soldered to the specified demonstration board with impedance matching to 50 Ω and measured with 50 Ω network analyzer.
2. Unless noted otherwise, all frequency specifications are referenced to the nominal center frequency, f_c .
3. Rejection is measured as attenuation below the minimum IL point in the passband. Rejection in final user application is dependent on PCB layout and external impedance matching design. See Application Note No. 42 for details.
4. The design, manufacturing process, and specifications of this filter are subject to change.
5. Either Port 1 or Port 2 may be used for either input or output in the design. However, impedances and impedance matching may vary between Port 1 and Port 2, so that the filter must always be installed in one direction per the circuit design.
6. US and international patents may apply.
7. RFM, stylized RFM logo, and RF Monolithics, Inc. are registered trademarks of RF Monolithics, Inc.

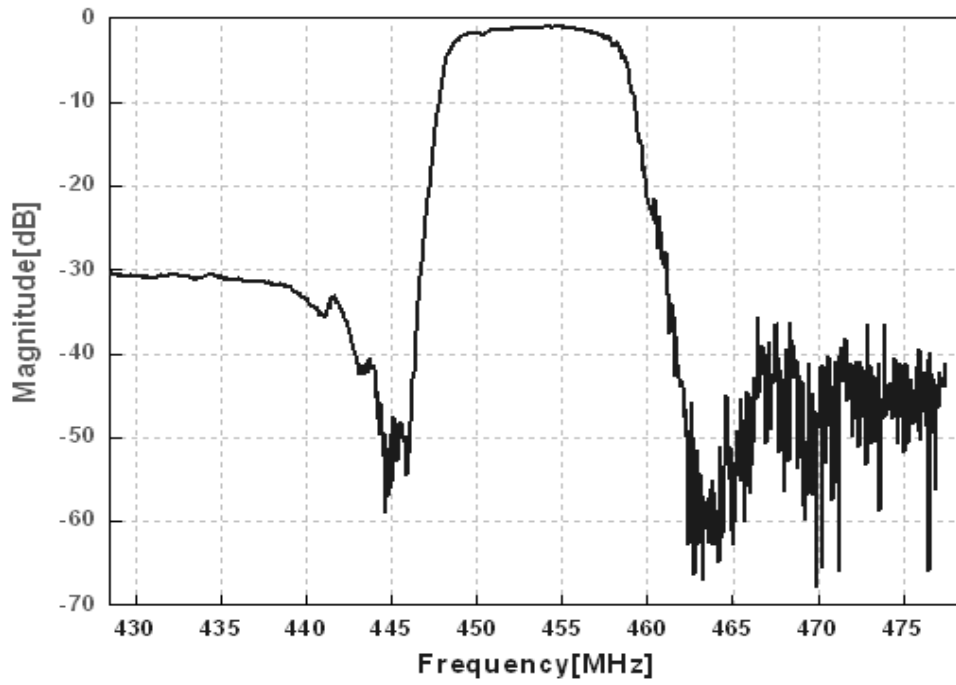

Filter Broadband Response

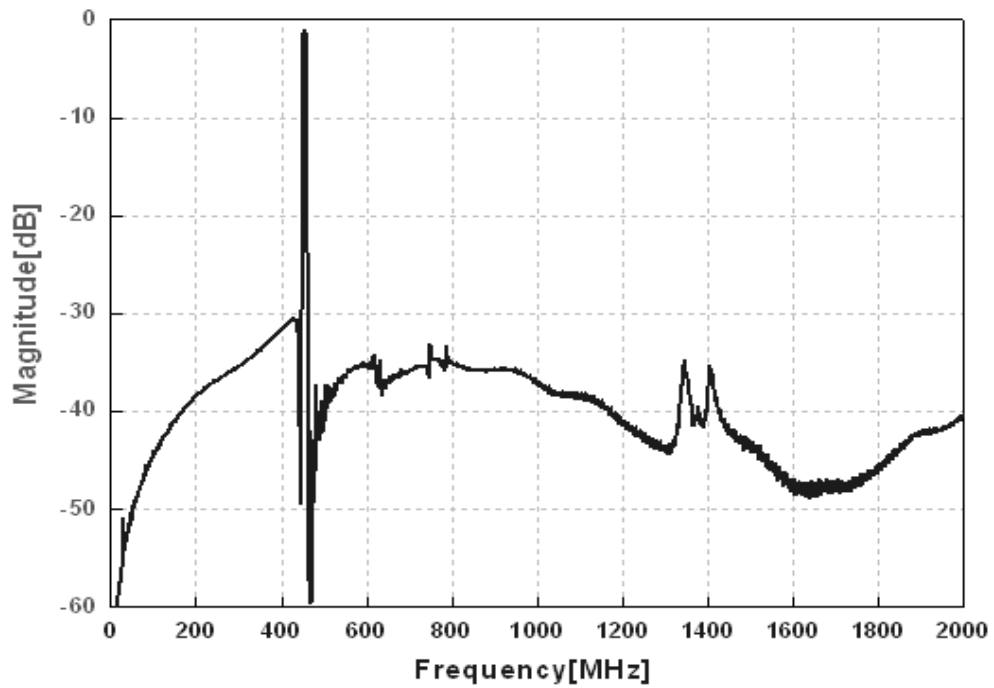

Filter Input Impedance

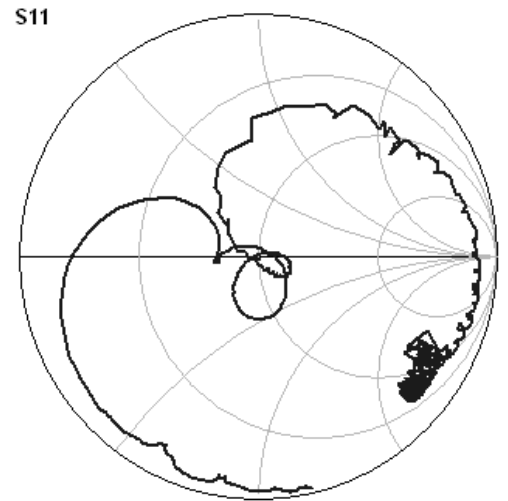
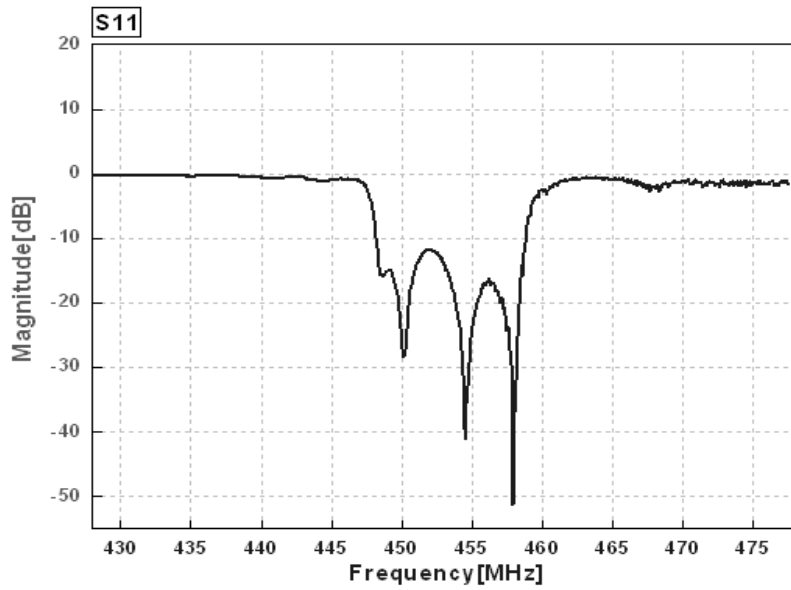

Filter Output Impedance

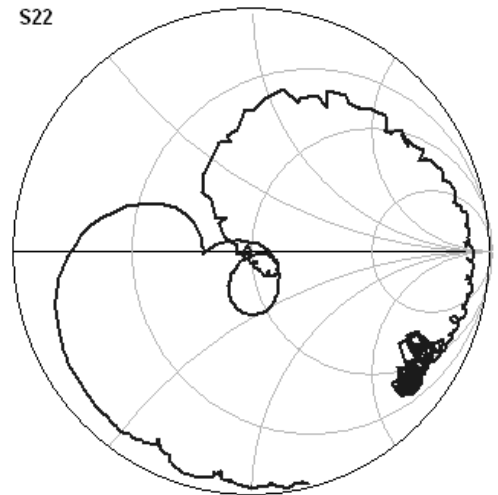
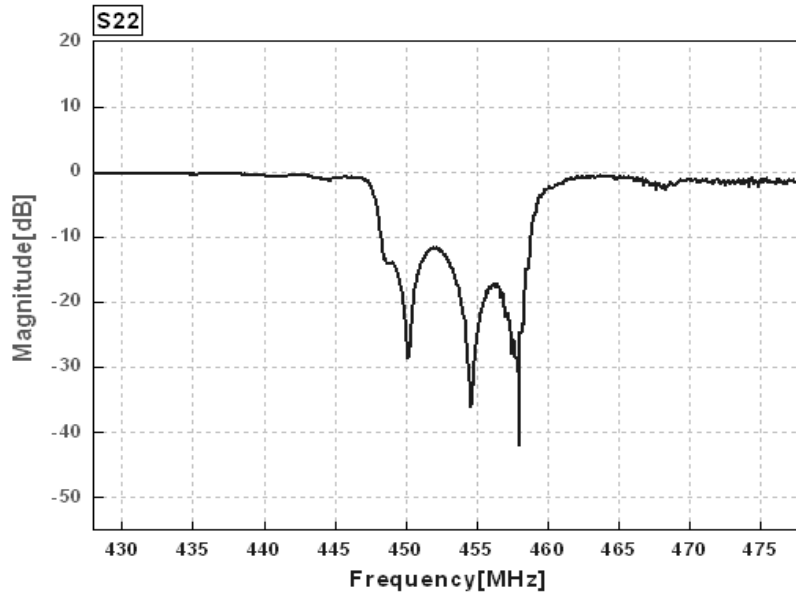

SM3838-6 Case

6-Terminal Ceramic Surface-Mount Case

3.8 X 3.8 mm Nominal Footprint

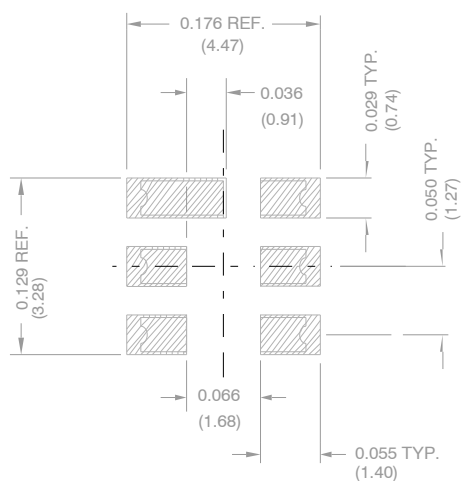
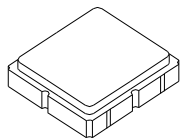

PCB Footprint

Case Dimensions

Dimension	mm			Inches		
	Min	Nom	Max	Min	Nom	Max
A	3.60	3.80	4.0	0.14	0.15	0.16
B	3.60	3.80	4.0	0.14	0.15	0.16
C	1.30	1.50	1.70	0.05	0.06	0.067
D	0.95	1.10	1.25	0.037	0.043	0.05
E	2.39	2.54	2.69	0.090	0.10	0.110
G	0.90	1.0	1.10	0.035	0.04	0.043
H	1.90	2.0	2.10	0.75	0.08	0.83
I	0.50	0.6	0.70	0.020	0.024	0.028
J	1.70	1.8	1.90	0.067	0.07	0.075

Electrical Connections

Connection	Terminals	
Port 1	Single-ended Input	2
Port 2	Single-ended Output	5
	Ground	All others
Single-ended Operation Only		
Dot indicates Pin 1		

Materials

Solder Pad Plating	0.3 to 1.0 μm Gold over 1.27 to 8.89 μm Nickel
Lid Plating	2.0 to 3.0 μm Nickel
Body	Al_2O_3 Ceramic
Pb Free	

TOP VIEW

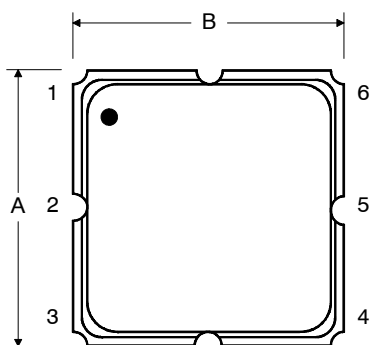

BOTTOM VIEW

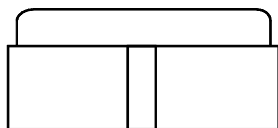
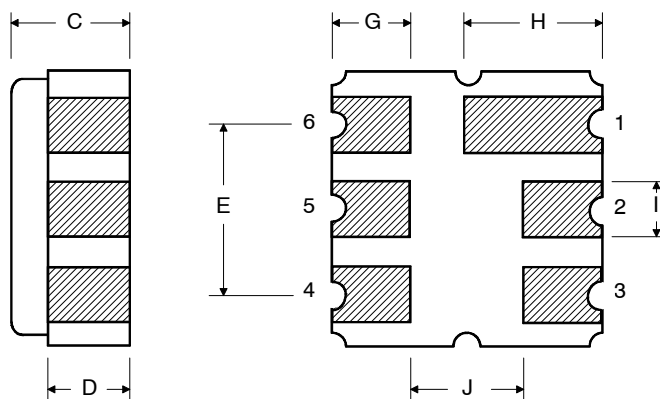

Tape and Reel Specifications

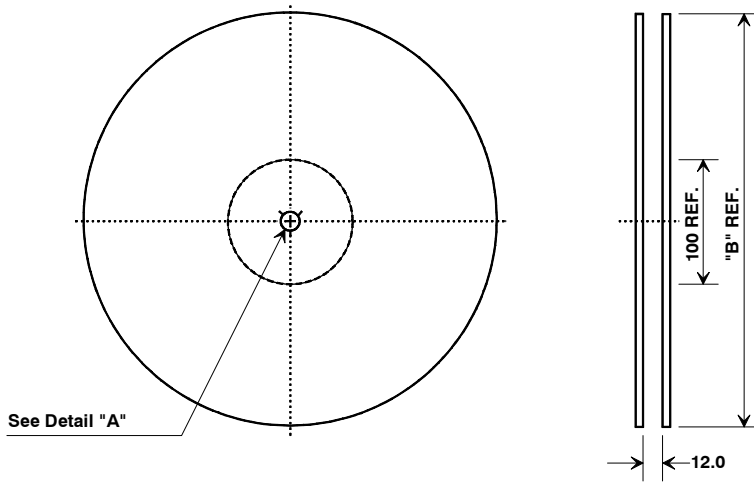

"B"		Quantity Per Reel
Inches	millimeters	
7	178	1000
13	330	3000

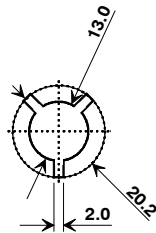

COMPONENT ORIENTATION and DIMENSIONS

Carrier Tape Dimensions	
Ao	4.25 mm
Bo	4.25 mm
Ko	1.30 mm
Pitch	8.0 mm
W	12.0 mm

