

GJ1386

PNP EPITAXIAL SILICON TRANSISTOR

Description

The GJ1386 is designed for low frequency applications.

Features

- Low $V_{CE(sat)} = -0.55V$ (Typ.) ($I_C/I_B = -4A/-0.1A$)
- Excellent DC current gain characteristics

Package Dimensions

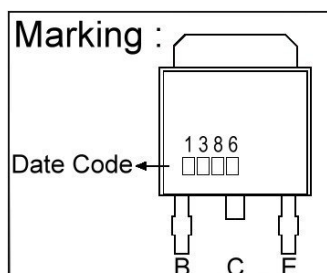
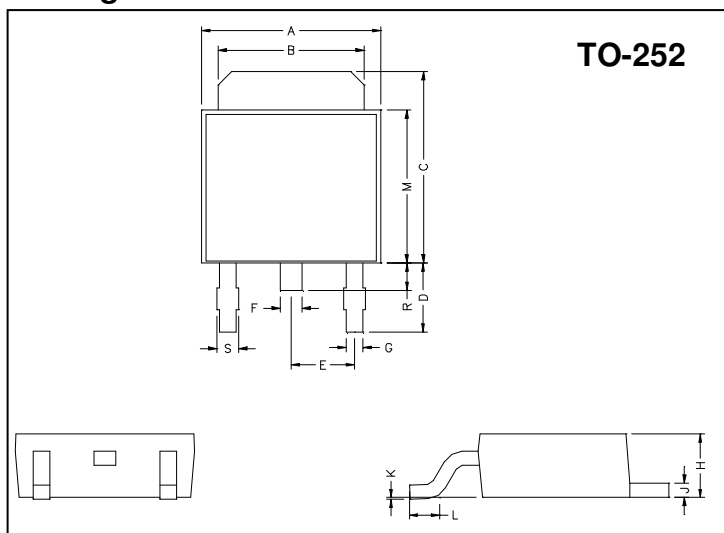

REF.	Millimeter		REF.	Millimeter	
	Min.	Max.		Min.	Max.
A	6.40	6.80	G	0.50	0.70
B	5.20	5.50	H	2.20	2.40
C	6.80	7.20	J	0.45	0.55
D	2.40	3.00	K	0	0.15
E	2.30 REF.		L	0.90	1.50
F	0.70	0.90	M	5.40	5.80
S	0.60	0.90	R	0.80	1.20

Absolute Maximum Ratings at $T_a = 25^\circ C$

Parameter	Symbol	Ratings	Unit
Junction Temperature	T_j	+150	$^\circ C$
Storage Temperature	T_{stg}	-55~+150	$^\circ C$
Collector to Base Voltage	V_{CB0}	-30	V
Collector to Emitter Voltage	V_{CE0}	-20	V
Emitter to Base Voltage	V_{EB0}	-6	V
Collector Current	I_C	-5	A
*Collector Current (Pulse)	I_C	-10	A
Total Power Dissipation ($T_C=25^\circ C$)	P_D	20	W

Electrical Characteristics ($T_a = 25^\circ C$)

Symbol	Min.	Typ.	Max.	Unit	Test Conditions
BV_{CB0}	-30	-	-	V	$I_C = -50\mu A, I_E = 0$
BV_{CE0}	-20	-	-	V	$I_C = -1mA, I_B = 0$
BV_{EB0}	-6	-	-	V	$I_E = -50\mu A, I_C = 0$
I_{CB0}	-	-	-500	nA	$V_{CB} = -20V, I_E = 0$
I_{EB0}	-	-	-500	nA	$V_{EB} = -5V, I_C = 0$
* $V_{CE(sat)}$	-	-	-1	V	$I_C = -4A, I_B = -0.1A$
* h_{FE}	82	-	580		$V_{CE} = -2V, I_C = -0.5A$
fT	-	120	-	MHz	$V_{CE} = -6V, I_E = 50mA, f = 30MHz$
Cob	-	60	-	pF	$V_{CB} = -20V, I_E = 0, f = 1MHz$

* Pulse Test: Pulse Width $\leq 380\mu s$, Duty Cycle $\leq 2\%$

Classification Of h_{FE}

Rank	P	Q	R	E
Range	82 - 180	120 - 270	180 - 390	370 - 580

Characteristics Curve

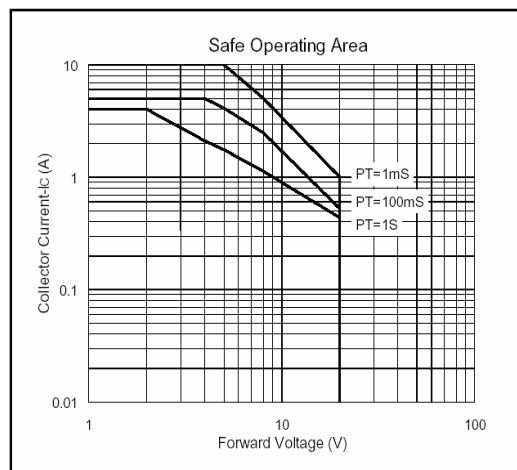
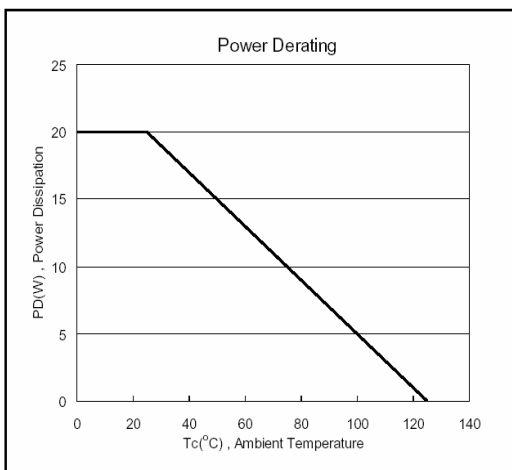
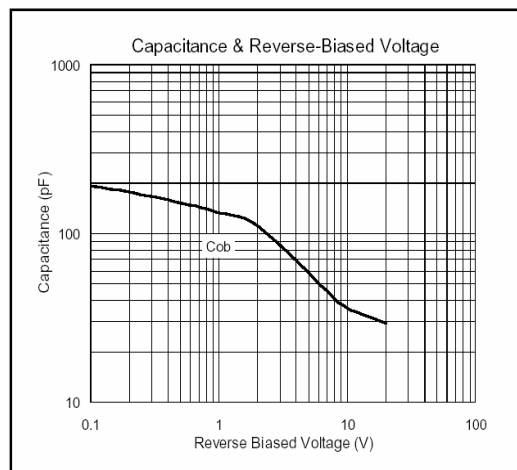
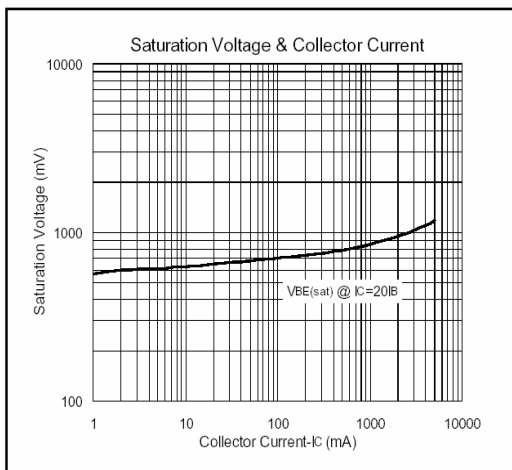
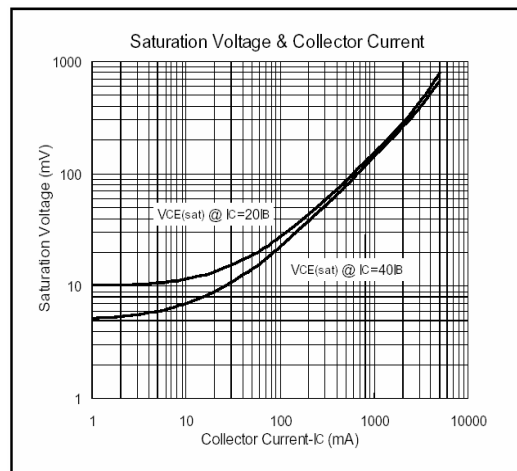
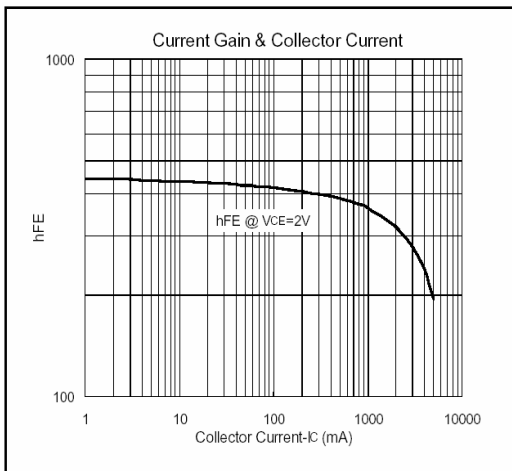

Important Notice:

- All rights are reserved. Reproduction in whole or in part is prohibited without the prior written approval of GTM.
- GTM reserves the right to make changes to its products without notice.
- GTM semiconductor products are not warranted to be suitable for use in life-support Applications, or systems.
- GTM assumes no liability for any consequence of customer product design, infringement of patents, or application assistance.

Head Office And Factory:

- **Taiwan:** No. 17-1 Tatung Rd. Fu Kou Hsin-Chu Industrial Park, Hsin-Chu, Taiwan, R. O. C.
- TEL : 886-3-597-7061 FAX : 886-3-597-9220, 597-0785
- **China:** (201203) No.255, Jang-Jiang Tsai-Lueng RD. , Pu-Dung-Hsin District, Shang-Hai City, China
- TEL : 86-21-5895-7671 ~ 4 FAX : 86-21-38950165