

Double Balanced Mixer

Model MO4xxG

Octave Band

RF 4.0 to 8.0 GHz

Electrical Specifications:⁽¹⁾

Parameter	Conditions			Specifications		
	RF (GHz)	LO (GHz)	IF (MHz)	Min	Typical	Max
SSB Conversion loss: ^{(2) (3)}	4.0-8.0	3.5-8.5	DC-500		5.5 dB	7.0 dB
	4.0-8.0	3.5-8.5	DC-1500		7.0 dB	8.5 dB
	4.0-8.0	3.5-8.5	DC-2000		8.5 dB	10.5 dB
Isolation LO to RF: LO to IF: RF to IF:		3.5-8.5		25 dB	38 dB	
	4.0-8.0	3.5-8.5		20 dB	30 dB	30 dB
Input 1 dB Compression Point:	4.0-8.0	3.5-8.5	DC-2000		+1 dBm +4 dBm +8 dBm +12 dBm	MO43 MO44 MO46 MO47
Input Third Order Intercept Point:	4.0-8.0	3.5-8.5	DC-2000		+11 dBm +14 dBm +18 dBm +22 dBm	MO43 MO44 MO46 MO47
LO Power: ⁽⁴⁾	4.0-8.0	3.5-8.5	DC-2000		+7 dBm +10 dBm +14 dBm +19 dBm	MO43 MO44 MO46 MO47

Model MO4xxG

LO Power

3 = +7 dBm
4 = +10 dBm
6 = +14 dBm
7 = +19 dBm

Drop-In Module or With SMA(F) Connectors
M = Module
P = With Connectors

Notes:

- Specifications are guaranteed when tested as a downconverter in a 50 Ohm system from -55°C to +100°C with the nominal LO power. Specifications indicated as typical are not guaranteed.
- Noise figure is typically within ±0.5 dB of conversion loss for IF frequencies greater than 10 MHz.
- Conversion loss typically degrades less than 0.5 dB at +100°C and improves less than 0.5 dB at -55°C.
- Usable LO drives are up to 2 dB below and 3 dB above nominal.

Typical Performance at 25°C

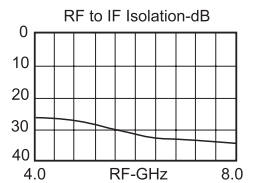

Conversion Loss (100MHz IF)-dB

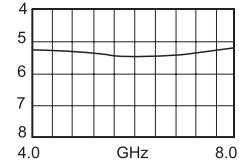

LO to RF, LO to IF Isoaltion-dB

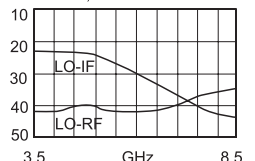

LO VSWR

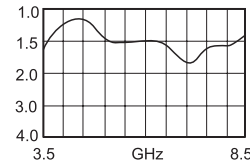

RF VSWR

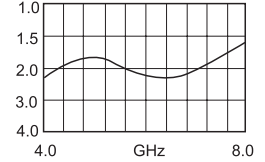

IF VSWR

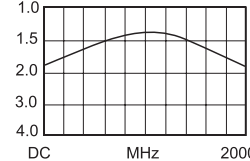

Relative Conv. Loss vs. IF Freq-dB

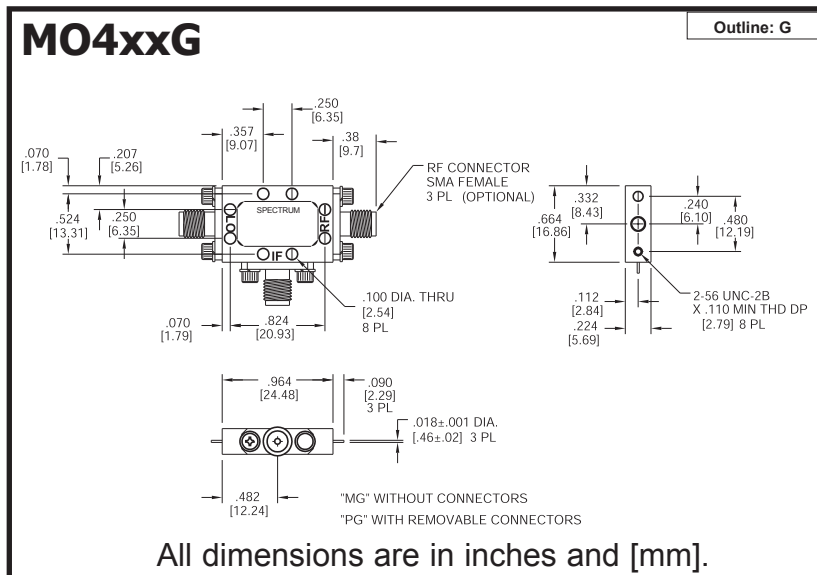
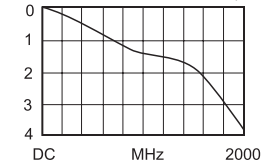

Spectrum Microwave · 2144 Franklin Drive N.E. · Palm Bay, FL 32905 · PH (888) 553-7531 · Fax (888) 553-7532

www.SpectrumMicrowave.com Spectrum Microwave (Europe) · 2707 Black Lake Place · Philadelphia, PA 19154 · PH (215) 464-4000 · Fax (215) 464-4001