

Encoder Line Drivers

Technical Data

HEDL-550X/554X
HEDL-556X/557X
HEDL-560X/564X
HEDL-9000/9100/9200
HEDL-9040/9140
HEDL-9060/9160/9260
HEDL-9061/9161

Features

- Available on Both Encoder Modules (HEDS-9000 Series) and Encoder Kit Housings (HEDS-5500 Series)
- Complementary Outputs
- Industry Standard Line Driver IC
- Single 5 V Supply
- Onboard Bypass Capacitor
- 70°C and 100°C Versions Available

Description

Line Drivers are available for the HEDS-55XX/56XX series and the HEDS-9000/9100/9200/9040/

9140 series encoders. The line driver offers enhanced performance when the encoder is used in noisy environments, or when it is required to drive long distances.

The 70°C version utilizes an industry standard line driver IC (26LS31) which provides complementary outputs for each encoder channel. The 100°C version utilizes an industry standard line driver IC, 26C31, which provides complementary outputs for each encoder channel. Thus, the output of the line driver encoder is A, \bar{A} , B, \bar{B} and I, \bar{I} for three channel versions. Suggested line receivers are 26LS32 and 26LS33.

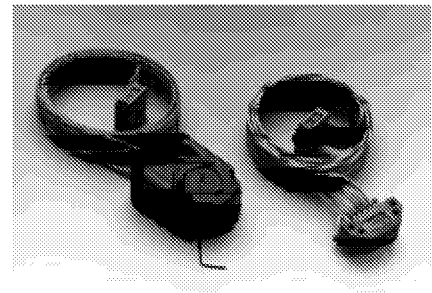

For additional information, please refer to:
HEDS-5500/5540/5600/5640 data sheet,
HEDS-90X0/91X0/92X0 data sheets,
HEDS-9000 series extended resolution data sheet, and
26LS31 data sheet.

Device Characteristics

Parameter	Characteristic	Notes
Termination	10 conductor ribbon cable with 10 position IDC Berg connector	See pinout
Electrical Outputs	Complementary outputs: A, \bar{A} , B, \bar{B} , I, \bar{I}	I and \bar{I} available only on three channel encoders
Line Driver Components	26LS31 line driver IC, decoupling capacitor on PC board.	
Operating Temperature Range	0°C to 70°C	70°C Series
	0°C to 100°C	100°C Series
Storage Temperature	-40°C to 70°C	70°C Series
	-40°C to 100°C	100°C Series

ESD WARNING: NORMAL HANDLING PRECAUTIONS SHOULD BE TAKEN TO AVOID STATIC DISCHARGE.

Line Driver Package Dimensions

For Detailed Dimensions on encoder packages, please refer to the respective data sheets.

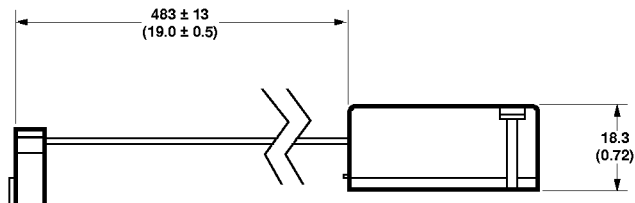
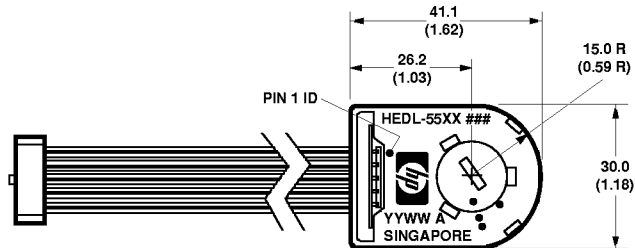

HEDL-550X/554X/560X/564X
HEDL-556X/557X

NOTE: DIMENSIONS IN MILLIMETERS (INCHES)

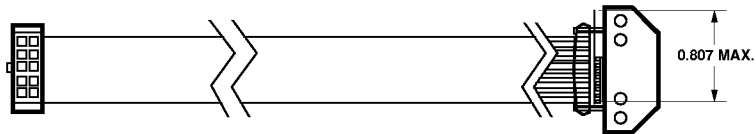
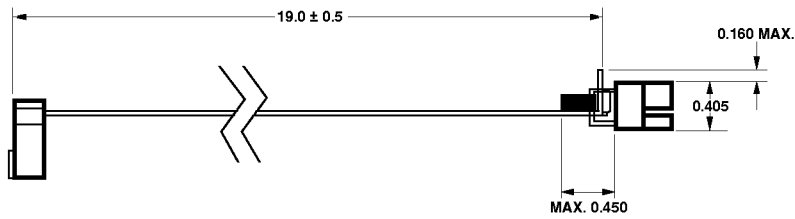

HEDL-9000/9100/9200/9040/9140
HEDL-9060/9160/9260/9061/9161

Waveforms

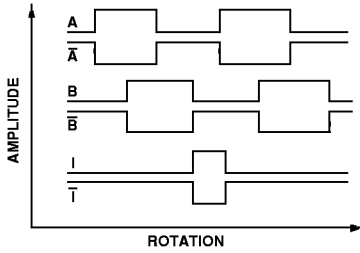

Block Diagram

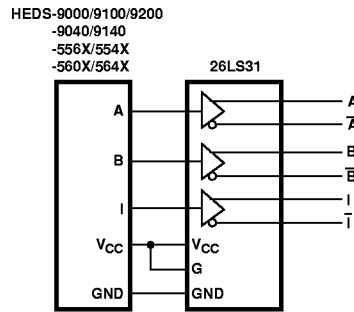

Pinouts

10-PIN CONNECTOR		
NO.	COLOR	PARAMETER
1	BROWN	NC
2	RED	V _{CC} (+5 V)
3	ORANGE	GND
4	YELLOW	NC
5	GREEN	A
6	BLUE	A-bar
7	VIOLET	B
8	GREY	B-bar
9	WHITE	I
		I-bar (INDEX)

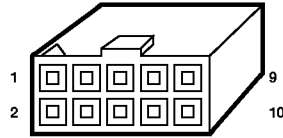

10 POSITION IDC CONNECTOR
CENTER POLARIZED.

Note: I/I-bar only available on three channel encoders.

Line Driver Base Parts Available:

70°C Line Driver Base Part	100°C Line Driver Base Part	Channels	Refer to the following encoder data sheet for additional information and option codes (XXX = resolution and/or shaft size)
HEDL-5500#XXX	HEDL-5568#XXX	A, B	HEDS-5500#XXX
HEDL-5505#XXX	HEDL-5569#XXX	A, B	HEDS-5505#XXX
HEDL-5540#XXX	HEDL-5570#XXX	A, B, I	HEDS-5540#XXX
HEDL-5545#XXX	HEDL-5571#XXX	A, B, I	HEDS-5545#XXX
HEDL-5600#XXX	HEDL-5572#XXX	A, B	HEDS-5600#XXX
HEDL-5605#XXX	HEDL-5573#XXX	A, B	HEDS-5605#XXX
HEDL-5640#XXX	HEDL-5574#XXX	A, B, I	HEDS-5640#XXX
HEDL-5645#XXX	HEDL-5575#XXX	A, B, I	HEDS-5645#XXX
HEDL-9000#XXX	HEDL-9060#XXX	A, B	HEDS-9000#XXX
HEDL-9040#XXX	HEDL-9061#XXX	A, B, I	HEDS-9040#XXX
HEDL-9100#XXX	HEDL-9160#XXX	A, B	HEDS-9100#XXX
HEDL-9140#XXX	HEDL-9161#XXX	A, B, I	HEDS-9140#XXX
HEDL-9200#XXX	HEDL-9260#XXX	A, B	HEDS-9200#XXX

Ordering Information:

For option code selection, refer to the data sheet for the corresponding "HEDS" part number (see right column).