

HEXFRED™

Ultrafast, Soft Recovery Diode

Features

- Reduced RFI and EMI
- Reduced Snubbing
- Extensive Characterization of Recovery Parameters
- Hermetic
- Electrically Isolated
- Ceramic Eyelets

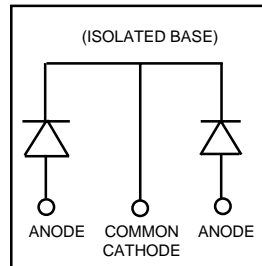

$V_R = 600V$
$V_F = 1.56V$
$Q_{rr} = 270nC$
$di_{(rec)}/dt = 345A/\mu s$

Description

HEXFRED™ diodes are optimized to reduce losses and EMI/RFI in high frequency power conditioning systems. An extensive characterization of the recovery behavior for different values of current, temperature and di/dt simplifies the calculations of losses in the operating conditions. The softness of the recovery eliminates the need for a snubber in most applications. These devices are ideally suited for power converters, motors drives and other applications where switching losses are significant portion of the total losses.

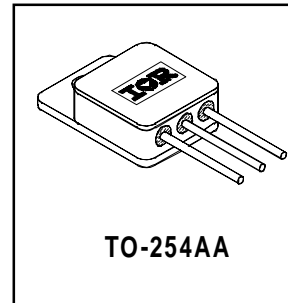

Absolute Maximum Ratings (per Leg)

	Parameter	Max.	Units
V_R	D.C. Reverse Voltage	600	V
$I_F @ T_C = 100^\circ C$	Continuous Forward Current ①	30	A
$I_{FSM} @ T_C = 25^\circ C$	Single Pulse Forward Current ②	150	
$P_D @ T_C = 25^\circ C$	Maximum Power Dissipation	63	W
T_J	Operating Junction and	-55 to +150	°C
T_{STG}	Storage Temperature Range		

Thermal - Mechanical Characteristics

	Parameter	Typ.	Max.	Units
$R_{\theta JC}$	Junction-to-Case, Single Leg Conducting	—	2.0	°C/W
	Weight	9.3	—	g

Note: ① D.C. = 50% rect. wave

② 1/2 sine wave, 60 Hz, P.W. = 8.33 ms

www.irf.com

HFA35HB60C

International
IRF Rectifier

Electrical Characteristics (per Leg) @ T_J = 25°C (unless otherwise specified)

	Parameter	Min.	Typ.	Max.	Units	Test Conditions
V _{BR}	Cathode Anode Breakdown Voltage	600	—	—	V	I _R = 250μA
V _{FM}	Max Forward Voltage	—	—	1.56	V	I _F = 15A
		—	—	1.92		I _F = 30A
		—	—	1.51		I _F = 15A, T _J = 125°C
I _{RM}	Max Reverse Leakage Current	—	—	10	μA	V _R = V _R Rated
		—	—	1.0	mA	T _J = 125°C, V _R = 480V
C _T	Junction Capacitance	—	24	36	pF	V _R = 200V
L _S	Series Inductance	—	8.7	—	nH	Measured from center of bond pad to end of anode bonding wire

Dynamic Recovery Characteristics (per Leg) @ T_J = 25°C (unless otherwise specified)

	Parameter	Min.	Typ.	Max.	Units	Test Conditions
t _{rr1}	Reverse Recovery Time	—	54	88	ns	T _J = 25°C
t _{rr2}		T _J = 125°C				
I _{RRM1}	Peak Recovery Current	—	5.6	7.8	A	T _J = 25°C
I _{RRM2}		T _J = 125°C				
Q _{rr1}	Reverse Recovery Charge	—	180	270	nC	T _J = 25°C
Q _{rr2}		T _J = 125°C				
di _(rec) M/dt1	Peak Rate of Fall of Recovery Current	—	300	345	A/μs	T _J = 25°C
di _(rec) M/dt2		During t _b	—	190		285

Case Outline and Dimensions — TO-254AA

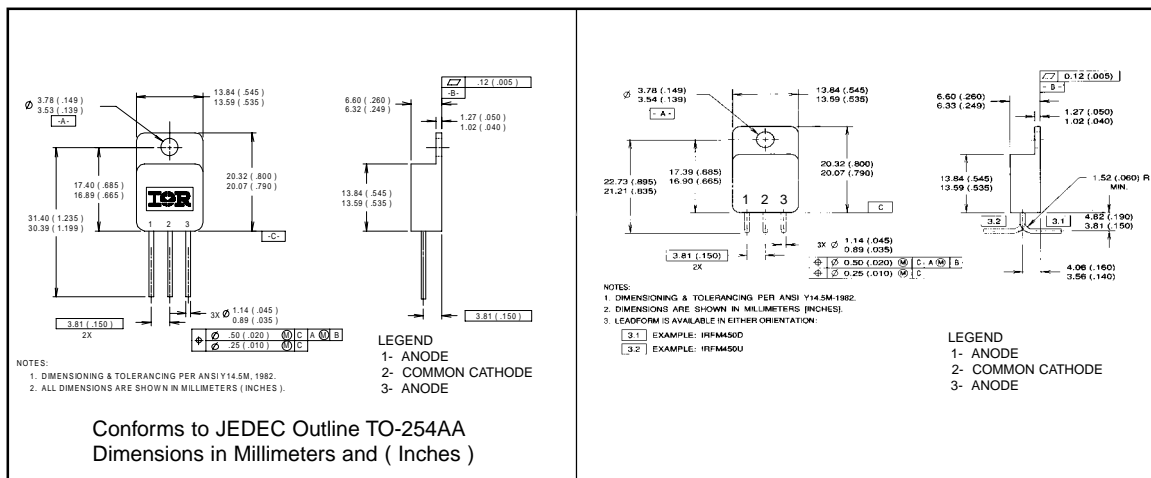

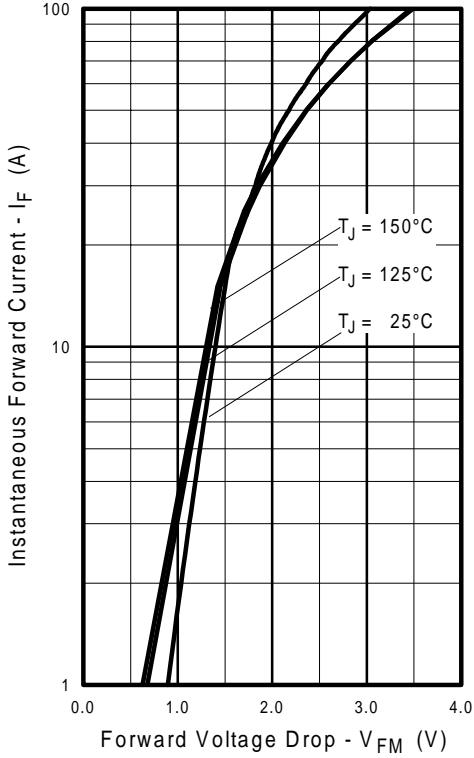

Fig. 1 - Maximum Forward Voltage Drop vs. Instantaneous Forward Current

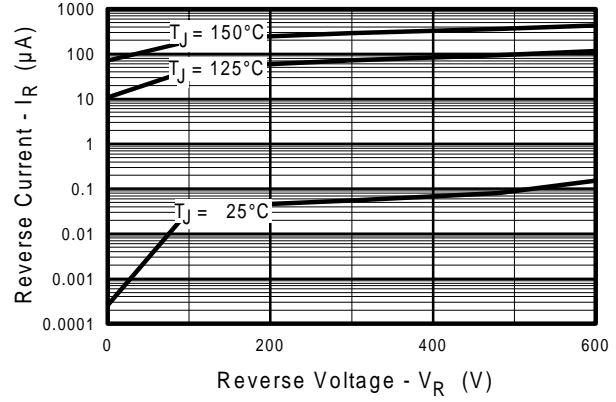

Fig. 2 - Typical Reverse Current vs. Reverse Voltage

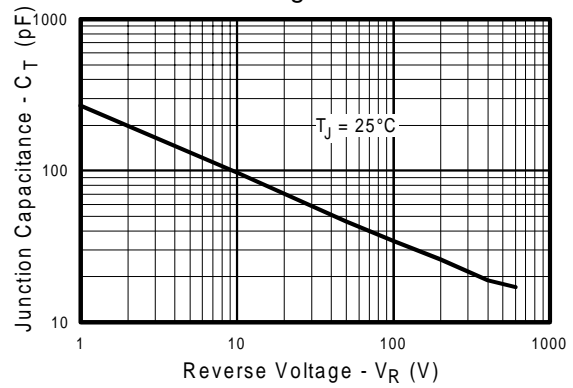

Fig. 3 - Typical Junction Capacitance vs. Reverse Voltage

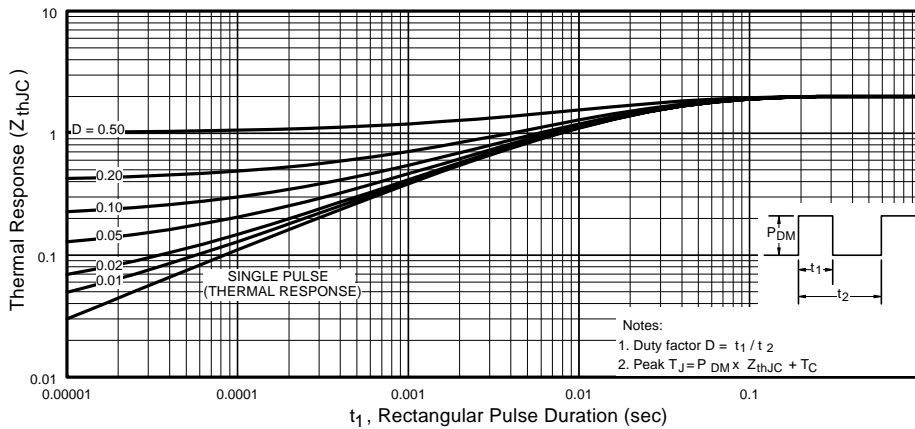

Fig. 4 - Maximum Thermal Impedance Z_{thJC} Characteristics

HFA35HB60C

International
IR Rectifier

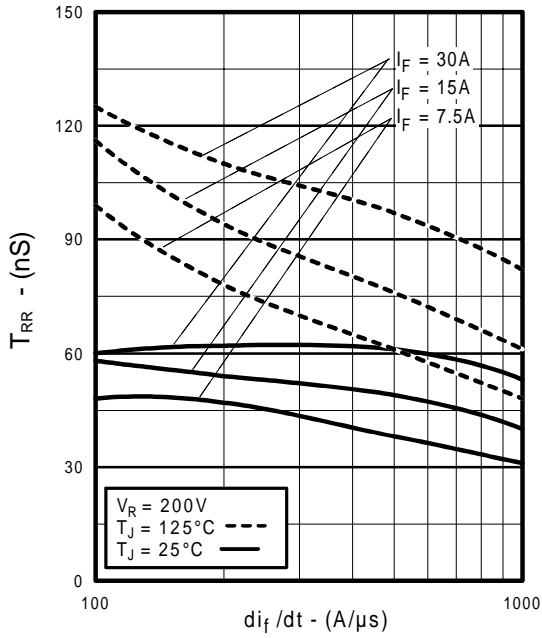

Fig. 5 - Typical Reverse Recovery vs. di_f/dt

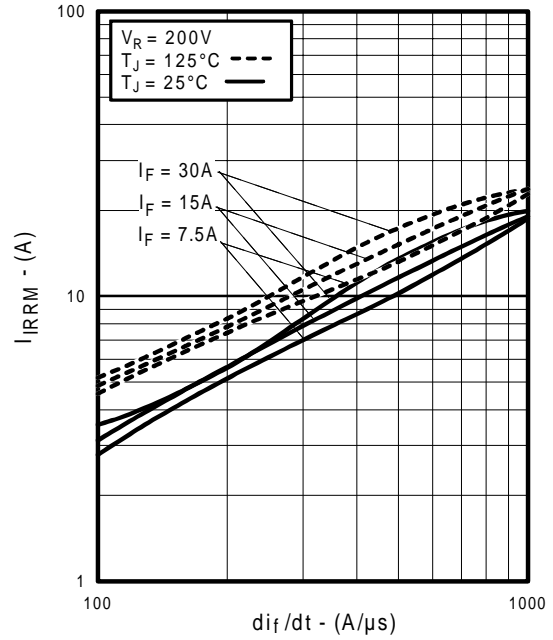

Fig. 6 - Typical Recovery Current vs. di_f/dt

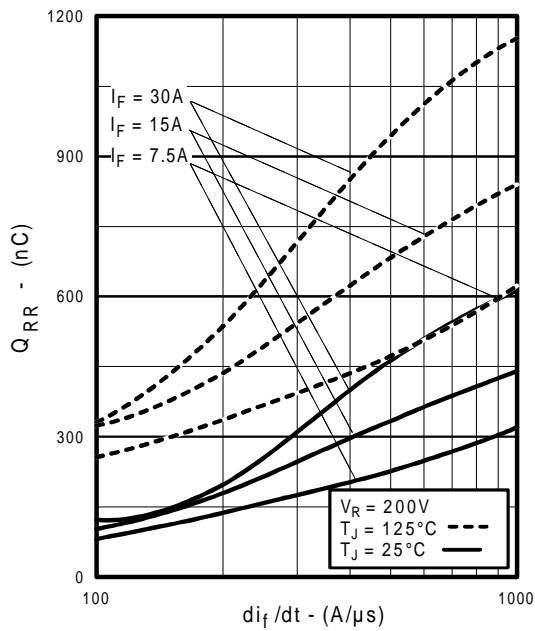

Fig. 7 - Typical Stored Charge vs. di_f/dt

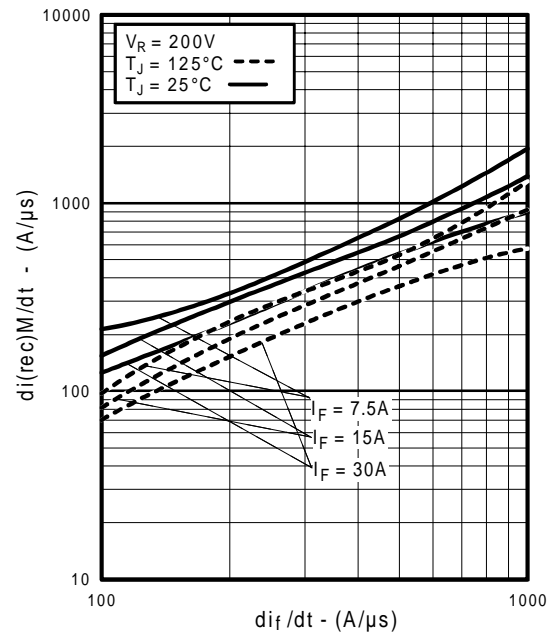

Fig. 8 - Typical $di_{(rec)M}/dt$ vs. di_f/dt

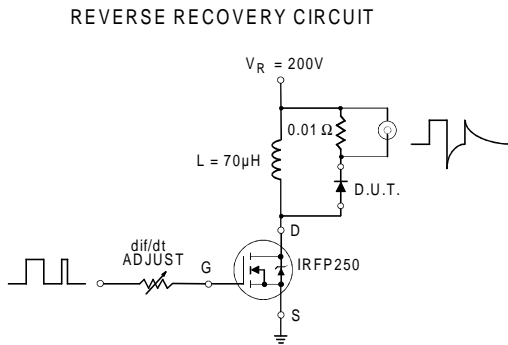

Fig. 9 - Reverse Recovery Parameter Test Circuit

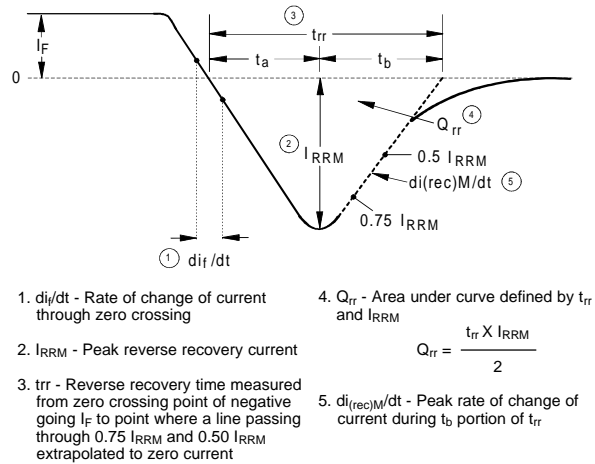

Fig. 10 - Reverse Recovery Waveform and Definitions