

SERIES

Serie

SnapN



SnapN Connectors - Compatible to N Connectors

Rosenberger introduces the first quick-lock connector which is compatible with N connectors. Due to the quick-lock coupling mechanism engagement force is approximately 30 N, the mating process of SnapN connectors is 10 times faster than installing standard N connectors. The outer diameter of 16 mm - smaller compared to standard N interface - leads to higher packing densities. SnapN connectors from Rosenberger - tools are not necessary - can be mated even in the tightest places.

SnapN right angle 360° turnable plugs can be turned to the required position after being mated. The innovative design of the quick-lock coupling mechanism virtually eliminates non-desired disengagement of the connection, e.g. by vibrations.

Rosenberger SnapN jacks (female) can be mated with N plugs (male) with standard interface.

Please always use the latching sleeve for locking and unlocking units.

Product Features

- Interface male compatible with: IEC 60169-16, CECC 22 210, MIL-PRF-39012
- Interface female according to: IEC 60169-16, CECC 22 210, MIL-PRF-39012
- Quality tested according to US MIL-STD 202
- Frequency range up to 11 GHz
- Return loss (straight connector): ≥ 25 dB 3-6 GHz (typ.)
- Quick locking system compatible to N
- Excellent Intermodulation
- High packing density
- 360° rotatable
- toolless mounting.

Product Range

- Cable connectors (straight and right angle) for flexible, semi-flex and semi-rigid cables
- Panel connectors.

The product range of SnapN connectors will be complemented by additional male and female types.

Further connectors are available on request.

Application Examples

- Filters for mobile base stations
- Cable connections for mobile base stations
- Test and measurement equipment
- Wireless LAN.

SnapN-Steckverbinder - rückwärtskompatibel zu Serie N

SnapN-Steckverbinder sind die ersten rückwärtskompatiblen Quick-Lock-Systeme für Standard-N-Verbinder. Der Quick-Lock-Einrastmechanismus erfordert eine sehr geringe Steckkraft von etwa 30 N, der Steckvorgang erfolgt ca. 10 mal schneller als bei Standard-Steckverbindern der Serie N. Durch den im Vergleich zum Standard-N-Interface kleineren Außendurchmesser von 16 mm wird eine deutlich höhere Packungsdichte erreicht, zudem sind SnapN-Steckverbinder von Rosenberger - da kein Werkzeug erforderlich ist - selbst an schwer zugänglichen Stellen montierbar.

Der SnapN-Winkelstecker ist um 360° drehbar - eine genaue Ausrichtung ist auch nach der Montage noch möglich. Durch das Design des Quick-Lock-Einrastmechanismus ist ein Lösen der Steckverbindung durch Stoß, Vibration usw. nahezu ausgeschlossen.

Rosenberger SnapN-Kuppler können mit Standard-N-Steckern verbunden werden.

Beim Ver- und Entriegeln des Steckers unbedingt Hülse betätigen.

Produkteigenschaften

- Interface Stecker kompatibel mit: IEC 60169-16, CECC 22 210, MIL-PRF-39012
- Interface Kuppler gemäß: IEC 60169-16, CECC 22 210, MIL-PRF-39012
- Qualitätsprüfung gemäß US MIL-STD 202
- Frequenzbereich bis 11 GHz
- Return Loss (gerader Steckverbinder): ≥ 25 dB 3-6 GHz (typ.)
- Rückwärtskompatibler Quick-Lock-Verschluss
- Ausgezeichnete Intermodulation
- Höhere Packungsdichte
- 10 mal schnellerer Steckvorgang
- 360° drehbar
- Montierbar ohne Werkzeug.

Produktspektrum

- Kabelsteckverbinder (gerade und gewinkelt) für flexible, Semi-Flex- und Semi-Rigid-Kabel
- Gehäuse-Steckverbinder.

Das Produktspektrum wird kontinuierlich um weitere SnapN-Typen ergänzt.

Weitere Steckverbinder auf Anfrage erhältlich.

Anwendungsbeispiele

- Filter für Mobilfunk-Basisstationen
- Mobilfunk-Verkabelungen
- Messtechnik
- Wireless LAN.

Interface Dimensions

Anschlussmaße

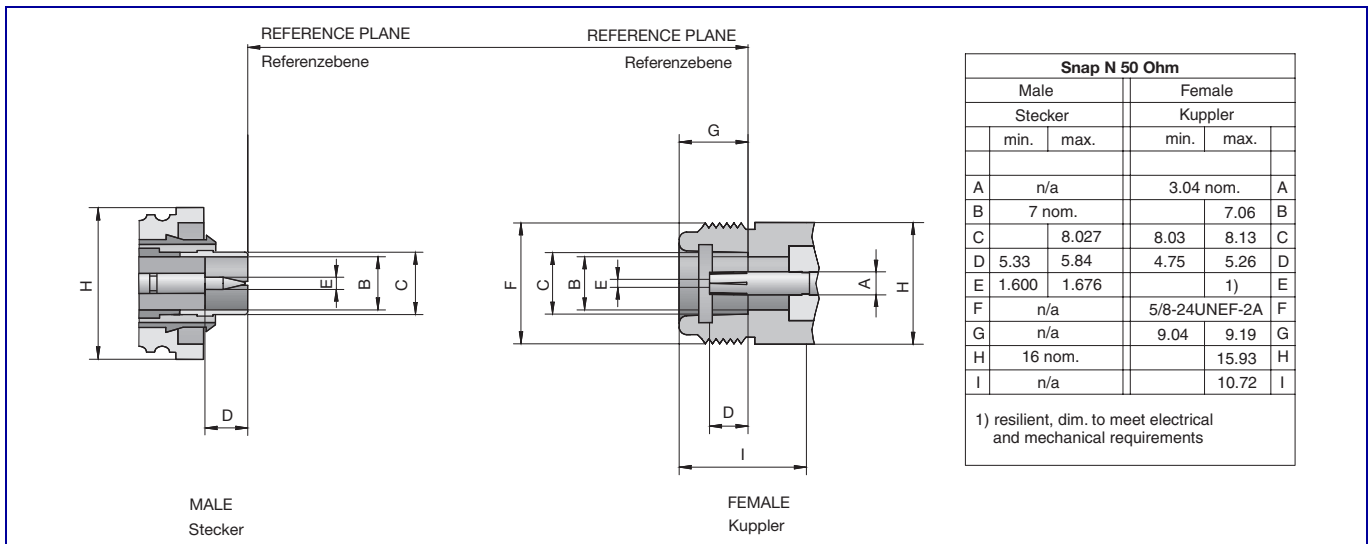

Technical Data

Technische Daten

Applicable standards		Anwendbare Standards
Interface male compatible with	IEC 60169- 16, CECC 22 210, MIL- PRF- 39012	Interface Stecker kompatibel mit
Interface female according to	IEC 60169- 16, CECC 22 210, MIL- PRF- 39012	Interface Kuppler gemäß
Quality tested according to	US MIL- STD 202	Qualitätsprüfung gemäß

Electrical data		Elektrische Daten
Impedance	50 Ω	Wellenwiderstand
Frequency range	DC...11 GHz	Frequenzbereich
Return loss	DC - 3 GHz ≤ 32 dB (typ.) 3 GHz - 6 GHz ≤ 25 dB (typ.) 6 GHz - 11 GHz ≤ 20 dB (typ.)	Rückflusdämpfung
Insertion loss	≤ 0.05 dB × √ f [GHz]	Einfügedämpfung
RF- leakage	100 MHz- 3GHz ≤ - 90dB (typ.) 3- 6 GHz ≤ - 80dB (typ.)	Schirmdämpfung
Insulation resistance	≥ 5 × 10 ³ MΩ	Isolationswiderstand
Center contact resistance	≤ 1 mΩ	Übergangswiderstand Innenleiter
Outer contact resistance	≤ 1 mΩ	Übergangswiderstand Außenleiter
Test voltage	2500 V rms	Prüfspannung
Working voltage	1400 V rms	Betriebsspannung
Intermodulation (3 rd order @ 2x20 W)	≥ 112 dBm (typ.)	Intermodulation (3. Ordnung bei 2x20 W)
Power handling	300 W @ 2.5 GHz	Leistungsbelastbarkeit

Mechanical data		Mechanische Daten
Mating cycles	> 200	Steckzyklen
Engagement force	30N (typ.)	Steckkraft
Disengagement force	30N (typ.)	Ziehkraft
Center contact captivation	axial: ≥ 28 N radial: ≥ 3 Ncm	Innenleiter Haltekraft

Environmental data		Umweltdaten
Temperature range	- 40°C - +125°C	Temperaturbereich
Thermal shock	IEC 60169- 1, 16.4, - 40 °C / 125 °C	Temperaturwechsel
Climatic sequence	IEC 60169- 1, 16.2, 40 / 125 / 21	Klimafolge
Vibration	US MIL- STD 202, Meth. 204, Cond. A 10- 500 Hz, 5 g	Vibration
Shock	US MIL- STD 202, Meth. 213, Cond. I	Schock
Damp heat	IEC 60169- 1, 16.3	Feuchte Wärme
Mixed flowing gas	DIN EN 60068- 2- 60, meth. 4	Schadgas

Materials		Materialien
Body	CuZn / Ag, White bronze plating	Gehäuse
Center contact	Brass, CuSn / Au, Ag plating	Innenleiter
Outer contact	CuZn / Ag, White bronze plating	Außenleiter
Unlocking sleeve	CuZn / White bronze plating	Entriegelungshülse
Insulator	PTFE	Isolierteil

Please always use the latching sleeve for locking and unlocking units.

Rosenberger- connectors fulfill in principle the indicated data of the Technical Data. Individual values of connectors may deviate depending upon application, design, type of cable, assembly method and execution. Specific data sheets for particular products can be provided on request from your Rosenberger sales partner.

Beim Ver- und Entriegeln des Steckers unbedingt Hülse betätigen.

Rosenberger- Steckverbinder erfüllen grundsätzlich die in den Technischen Daten angegebenen Daten. Je nach Anwendung, Bauart, Kabeltyp, Montageart und -ausführung können einzelne Werte von Steckverbindern hiervon abweichen. Spezifische Datenblätter zu einzelnen Produkten erhalten Sie auf Anfrage von Ihrem Rosenberger- Ansprechpartner.

Cable Connectors - Semi-Rigid Cable

Kabel-Steckverbinder - Semi-Rigid-Kabel

Straight Plug, solder

Stecker gerade, löt

Semi-Rigid

Ordering Number	Remarks	Cable Group	Assembly Instruction	Packing Unit
53 QS 101- 272 B5	a = 26.7 * 6.1 mated	72	53 T14	50
53 QS 101- 273 N5	a = 29.9 * mated	73	53 T17	50

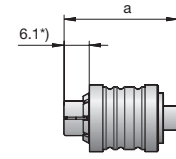

Right Angle Plug, solder

Winkelstecker, löt

Semi-Rigid

Ordering Number	Remarks	Cable Group	Assembly Instruction	Packing Unit
53 QS 205- 272 N1	a = 26.7 * 6.1 mated	72	53 T20	50

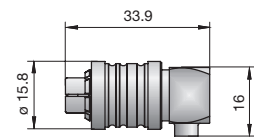

Straight Jack, solder

Kuppler gerade, löt

Semi-Rigid

Ordering Number	Cable Group	Assembly Instruction	Packing Unit
53 QK 101- 272 B5	72	53 T2	50
53 QK 101- 273 N5	73	53 T18	50

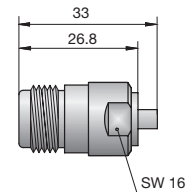

Straight Panel Jack, solder

Gehäusekuppler, gerade, löt

Semi-Rigid

Ordering Number	Version	Cable Group	Assembly Instruction	Panel Piercing / PCB Layout	Packing Unit
53 QK 501- 272 N5	rear mount	72	53 T2	B 13	50
53 QK 501- 273 N5	rear mount	73	53 T18	B 13	50

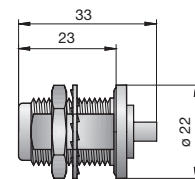

Cable Connectors - Flexible Cables

Kabelsteckverbinder Flexible Kabel

Straight Plug, crimp

Stecker gerade, crimp

Flexible Cables

Ordering Number	Remarks	Cable Group	Assembly Instruction	Crimp Inserts	Packing Unit
53 QS 107-106 N5	a = 37.9, b = 13.5 * mated	06	53 P2	11 W 150-208	100
53 QS 107-108 N5	a = 37.9, b = 13.5 * mated	08	53 P2	11 W 150-208	100
53 QS 107-1Y8 N5	a = 36.4, b = 12 * mated	Y8	53 P2	11 W 150-209	100

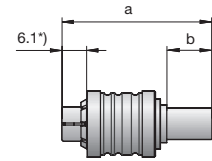

Right Angle Plug, crimp

Winkelstecker, crimp

Flexible Cables

Ordering Number	Remarks	Cable Group	Assembly Instruction	Crimp Inserts	Packing Unit
53 QS 205-306 N5	a = 22.7, b = 13.5 * mated	06	53 S11	11 W 150-208	50
53 QS 205-308 N5	a = 22.7, b = 13.5 * mated	08	53 S11	11 W 150-208	50
53 QS 20C-3Y8 N	a = 21.9, b = 12 * mated	Y8	53 S11	11 W 150-109	100

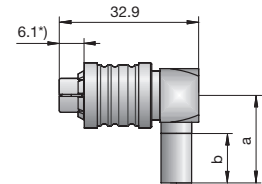

Straight Jack, crimp

Kuppler gerade, crimp

Flexible Cables

Ordering Number	Version	Cable Group	Assembly Instruction	Panel Piercing / PCB Layout	Crimp Inserts	Packing Unit
53 QK 507-106 N5	rear mount	06	53 P	B 13	11 W 150-208	50
53 QK 507-108 N5	rear mount	08	53 P	B 13	11 W 150-208	50
53 QK 507-1Y8 N5	rear mount	Y8	53 P1	B 13	11 W 150-209	50

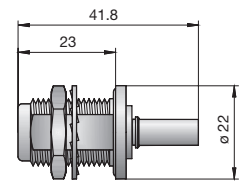

Panel Connectors - Solder End

Gehäuse-Steckverbinder - Lötkelch

Straight Panel Jack, 4-hole flange

Gehäusekuppler, gerade, 4-Loch-Flansch

Solder End

Ordering Number	Remarks	Panel Piercing / PCB Layout	Packing Unit
53 QK 401-200 N5	4 x Ø 3.4	B 12	50
53 QK 413-200 N5	4 x Ø 3.2	B 6	50

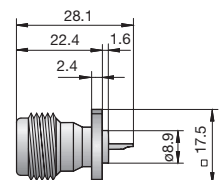
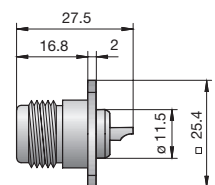

Adaptors (In- Serie)

Adapter (In- Serie)

SnapN

SnapN

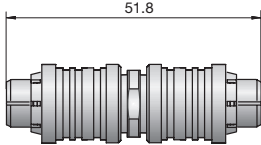
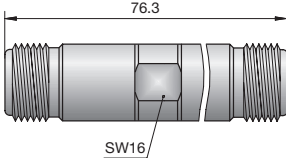
Ordering Number	Version	Remarks	Return Loss	Packing Unit	
53 QS 121- S20 S3	straight	SnapN male - male calibration adaptor	≥ 36 dB @ DC to 4 GHz ≥ 27 dB @ 4 GHz to 11 GHz	1	
53 QK 121- K20 S3	straight	SnapN female - female calibration adaptor	≥ 36 dB @ DC to 4 GHz ≥ 27 dB @ 4 GHz to 11 GHz	1	

Adaptors (Inter Series)

Adapter (serienübergreifend)

SnapN

SnapN

Ordering Number	Version	Remarks	Return Loss	Packing Unit	
53 QS 105- S00 S3	straight	SnapN male - RPC- N 50 Ω male	≥ 26 dB @ DC to 11 GHz	1	
53 QS 105- K00 S3	straight	SnapN male - RPC- N 50 Ω female	≥ 26 dB @ DC to 11 GHz	1	
53 QS 105- K20 S3	straight	SnapN male - RPC- N 50 Ω female calibration adaptor	≥ 36 dB @ DC to 4 GHz ≥ 27 dB @ 4 GHz to 11 GHz	1	
53 QK 105- S00 S3	straight	SnapN female - RPC- N 50 Ω male	≥ 28 dB @ DC to 11 GHz ≥ 26 dB @ 11 GHz to 18 GHz	1	
53 QK 105- S20 S3	straight	SnapN female - RPC- N 50 Ω male calibration adaptor	≥ 36 dB @ DC to 4 GHz ≥ 27 dB @ 4 GHz to 11 GHz	1	
53 QK 105- K00 S3	straight	SnapN female - RPC- N 50 Ω female	≥ 28 dB @ DC to 11 GHz ≥ 26 dB @ 11 GHz to 18 GHz	1	