

OUTLINE

The RN5RT Series are CMOS-based voltage regulator ICs with high output voltage accuracy and low supply current developed. Each of these voltage regulator ICs consists of a voltage reference unit, an error amplifier, output voltage setting resistors and a current limit circuit.

The output voltage of these ICs is fixed with high accuracy.

The built-in Driver Transistor of low ON Resistance permits developing of low dropout CMOS type regulator as RN5RT Series.

Even if V_{OUT} is shorted to GND, the current limit circuit protects the ICs from destruction.

Furthermore, these ICs have a chip enable function, so that the supply current on standby can be minimized.

Since the package for these ICs is the SOT-23-5 (Mini-mold) package, high density mounting of the ICs on boards is possible.

FEATURES

- Ultra-Low Supply Current.....Typ. 4 μ A (except ICEL)
- Standby Mode.....Typ. 0.1 μ A
- Low Dropout Voltage.....Typ. 0.3V ($I_{OUT}=60\text{mA}$, RN5RT30A)
- Low Temperature-Drift Coefficient of Output Voltage.....Typ. $\pm 100\text{ppm}/^{\circ}\text{C}$
- Excellent Line Regulation.....Typ. 0.15%/V
- Output Voltage.....Stepwise setting with a step of 0.1V in the range of 2.0V to 6.0V is possible (refer to Selection Guide).
- High Accuracy Output Voltage..... $\pm 2.0\%$
- Built-in Current Limit Circuit.....Typ. 30mA
- Small Package.....SOT-23-5 (Mini-mold)

APPLICATIONS

- Power source for battery-powered equipment.
- Power source for cellular phones, cameras, VCRs, camcorders, hand-held audio instruments and hand-held communication equipment.
- Power source for domestic appliances.

BLOCK DIAGRAM

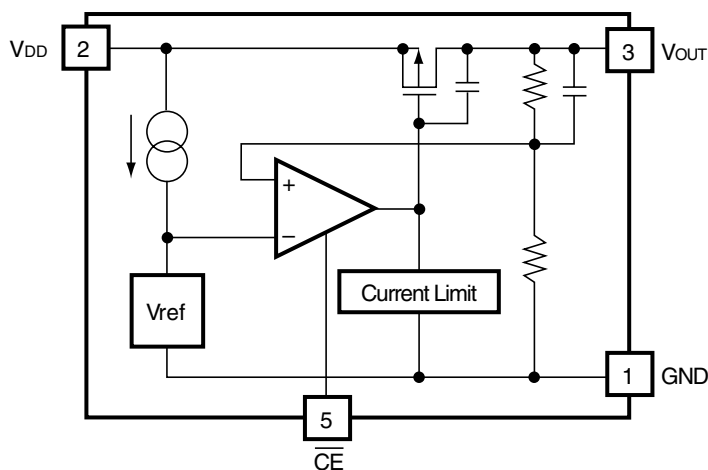

SELECTION GUIDE

The output voltage, the packing type, and the taping type for the ICs can be selected at the user's request. These selections can be made by designating the part number as shown below:

RN5RT xxxx-x ← Part Number
 ↑↑↑ ↑
 a b c d

Code	Contents
a	Setting Output Voltage (V _{OUT}) : Stepwise setting with a step of 0.1V in the range of 2.0V to 6.0V is possible.
b	A
c	Designation of Packing Type : A : Taping C : Antistatic bag (for Samples only)
d	Designation of Taping Type : Ex. TR, TL (refer to Taping Specifications ; TR type is the standard direction.)

PIN CONFIGURATION

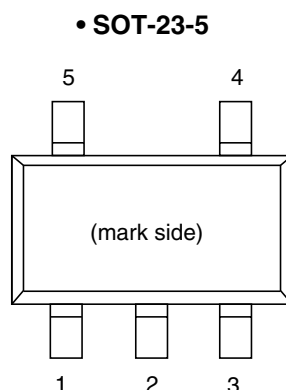

PIN DESCRIPTION

Pin No.	Symbol	Description
1	GND	Ground Pin
2	VDD	Input Pin
3	VOUT	Output Pin
4	NC	No Connection
5	$\overline{\text{CE}}$	Chip Enable Pin

ABSOLUTE MAXIMUM RATINGS

Symbol	Item	Ratings	Unit
V _{IN}	Input Voltage	9	V
V _{CE}	Input Voltage ($\overline{\text{CE}}$ Pin)	-0.3 to V _{IN} +0.3	V
V _{OUT}	Output Voltage	-0.3 to V _{IN} +0.3	V
I _{OUT}	Output Current	150	mA
P _D	Power Dissipation	150	mW
T _{opt}	Operating Temperature	-40 to +85	°C
T _{stg}	Storage Temperature	-55 to +125	°C
T _{solder}	Lead Temperature (Soldering)	260°C, 10s	

ABSOLUTE MAXIMUM RATINGS

Absolute Maximum ratings are threshold limit values that must not be exceeded even for an instant under any conditions. Moreover, such values for any two items must not be reached simultaneously. Operation above these absolute maximum ratings may cause degradation or permanent damage to the device. These are stress ratings only and do not necessarily imply functional operation below these limits.

ELECTRICAL CHARACTERISTICS

• RN5RT30A

T_{opt}=25°C

Symbol	Item	Conditions	Min.	Typ.	Max.	Unit
V _{OUT}	Output Voltage	V _{IN} =4.0V, I _{OUT} =10mA	2.940	3.000	3.060	V
I _{OUT}	Output Current	V _{IN} =4.0V	40	60		mA
$\frac{\Delta V_{OUT}}{\Delta I_{OUT}}$	Load Regulation	V _{IN} =4.0V 1mA ≤ I _{OUT} ≤ 60mA		40	80	mV
V _{DIF}	Dropout Voltage	I _{OUT} =60mA		0.3	0.5	V
I _{SS}	Supply Current	V _{IN} =4.0V (except I _{CEL})		4.0	10	μA
I _{standby}	Supply Current (Standby)	V _{IN} =V _{CE} =4.0V		0.1	1.0	μA
$\frac{\Delta V_{OUT}}{\Delta V_{IN}}$	Line Regulation	I _{OUT} =30mA V _{OUT} +0.5V ≤ V _{IN} ≤ 8.0V	0.00	0.15	0.30	%/V
V _{IN}	Input Voltage				8	V
$\frac{\Delta V_{OUT}}{\Delta T_{opt}}$	Output Voltage Temperature Coefficient	I _{OUT} =10mA -40°C ≤ T _{opt} ≤ 85°C		±100		ppm/°C
I _{lim}	Short Current Limit	V _{OUT} =0V		30		mA
V _{CEH}	\overline{CE} Input Voltage "H"		1.5			V
V _{CEL}	\overline{CE} Input Voltage "L"				0.25	V
I _{CEH}	\overline{CE} Input Current "H"	V _{CE} =V _{IN}		0.0	0.1	μA
I _{CEL}	\overline{CE} Input Current "L"	V _{CE} =0V	-4.0	-2.0	-0.1	μA

• RN5RT40A

Topt=25°C

Symbol	Item	Conditions	Min.	Typ.	Max.	Unit
V _{OUT}	Output Voltage	V _{IN} =5.0V, I _{OUT} =10mA	3.920	4.000	4.080	V
I _{OUT}	Output Current	V _{IN} =5.0V	50	80		mA
$\frac{\Delta V_{OUT}}{\Delta I_{OUT}}$	Load Regulation	V _{IN} =5.0V 1mA≤I _{OUT} ≤80mA		40	80	mV
V _{DIF}	Dropout Voltage	I _{OUT} =80mA		0.3	0.5	V
I _{SS}	Supply Current	V _{IN} =5.0V (except I _{CEL})		4	10	μA
I _{standby}	Supply Current (Standby)	V _{IN} =V _{CE} =5.0V		0.1	1.0	μA
$\frac{\Delta V_{OUT}}{\Delta V_{IN}}$	Line Regulation	I _{OUT} =30mA V _{OUT} +0.5V≤V _{IN} ≤8.0V		0.15	0.30	%/V
V _{IN}	Input Voltage				8	V
$\frac{\Delta V_{OUT}}{\Delta T_{opt}}$	Output Voltage Temperature Coefficient	I _{OUT} =10mA -40°C≤T _{opt} ≤85°C		±100		ppm/°C
I _{lim}	Short Current Limit	V _{OUT} =0V		30		mA
V _{CEH}	\overline{CE} Input Voltage "H"		1.5			V
V _{CEL}	\overline{CE} Input Voltage "L"				0.25	V
I _{CEH}	\overline{CE} Input Current "H"	V _{CE} =V _{IN}		0.0	0.1	μA
I _{CEL}	\overline{CE} Input Current "L"	V _{CE} =0V	-4.0	-2.0	-0.1	μA

• RN5RT50A

Topt=25°C

Symbol	Item	Conditions	Min.	Typ.	Max.	Unit
V _{OUT}	Output Voltage	V _{IN} =6.0V, I _{OUT} =10mA	4.900	5.000	5.100	V
I _{OUT}	Output Current	V _{IN} =6.0V	65	100		mA
$\frac{\Delta V_{OUT}}{\Delta I_{OUT}}$	Load Regulation	V _{IN} =6.0V 1mA≤I _{OUT} ≤100mA		40	80	mV
V _{DIF}	Dropout Voltage	I _{OUT} =100mA		0.3	0.5	V
I _{SS}	Supply Current	V _{IN} =6.0V (except I _{CEL})		4	10	μA
I _{standby}	Supply Current (Standby)	V _{IN} =V _{CE} =6.0V		0.1	1.0	μA
$\frac{\Delta V_{OUT}}{\Delta V_{IN}}$	Line Regulation	I _{OUT} =30mA V _{OUT} +0.5V≤V _{IN} ≤8.0V		0.15	0.30	%/V
V _{IN}	Input Voltage				8	V
$\frac{\Delta V_{OUT}}{\Delta T_{opt}}$	Output Voltage Temperature Coefficient	I _{OUT} =10mA -40°C≤T _{opt} ≤85°C		±100		ppm/°C
I _{lim}	Short Current Limit	V _{OUT} =0V		30		mA
V _{CEH}	\overline{CE} Input Voltage "H"		1.5			V
V _{CEL}	\overline{CE} Input Voltage "L"				0.25	V
I _{CEH}	\overline{CE} Input Current "H"	V _{CE} =V _{IN}		0.0	0.1	μA
I _{CEL}	\overline{CE} Input Current "L"	V _{CE} =0V	-4.0	-2.0	-0.1	μA

ELECTRICAL CHARACTERISTICS BY OUTPUT VOLTAGE

Part Number	Output Voltage			Output Current			Load Regulation			Dropout Voltage			Supply Current		
	V _{OUT} (V)			I _{OUT} (mA)			ΔV _{OUT} /ΔI _{OUT} (mA)			V _{DIF} (V)			I _{SS} (μA)		
	Conditions	Min.	Typ.	Max.	Conditions	Min.	Typ.	Conditions	Typ.	Max.	Conditions	Typ.	Max.	Conditions	Typ.
RN5RT20A	V _{IN} -V _{OUT} =1.0V I _{OUT} =10mA	1.960	2.000	2.040	V _{IN} -V _{OUT} =1.0V	25	40	V _{IN} -V _{OUT} =1.0V 1mA ≤ I _{OUT} ≤ 40mA	40	80	0.3	0.5	V _{IN} -V _{OUT} =1.0V (except I _{CEL})	4.0	10
RN5RT21A		2.058	2.100	2.142											
RN5RT22A		2.156	2.200	2.244											
RN5RT23A		2.254	2.300	2.346											
RN5RT24A		2.352	2.400	2.448											
RN5RT25A		2.450	2.500	2.550											
RN5RT26A		2.548	2.600	2.652											
RN5RT27A		2.646	2.700	2.754											
RN5RT28A		2.744	2.800	2.856											
RN5RT29A		2.842	2.900	2.958											
RN5RT30A		2.940	3.000	3.060											
RN5RT31A		3.038	3.100	3.162											
RN5RT32A		3.136	3.200	3.264											
RN5RT33A		3.234	3.300	3.366											
RN5RT34A		3.332	3.400	3.468											
RN5RT35A		3.430	3.500	3.570											
RN5RT36A		3.528	3.600	3.672											
RN5RT37A		3.626	3.700	3.774											
RN5RT38A		3.724	3.800	3.876											
RN5RT39A		3.822	3.900	3.978											
RN5RT40A		3.920	4.000	4.080											
RN5RT41A		4.018	4.100	4.182											
RN5RT42A		4.116	4.200	4.284											
RN5RT43A		4.214	4.300	4.386											
RN5RT44A		4.312	4.400	4.488											
RN5RT45A		4.410	4.500	4.590											
RN5RT46A		4.508	4.600	4.692											
RN5RT47A		4.606	4.700	4.794											
RN5RT48A		4.704	4.800	4.896											
RN5RT49A		4.802	4.900	4.998											
RN5RT50A	4.900	5.000	5.100												
RN5RT51A	4.998	5.100	5.202												
RN5RT52A	5.096	5.200	5.304												
RN5RT53A	5.194	5.300	5.406												
RN5RT54A	5.292	5.400	5.508												
RN5RT55A	5.390	5.500	5.610												
RN5RT56A	5.488	5.600	5.712												
RN5RT57A	5.586	5.700	5.814												
RN5RT58A	5.684	5.800	5.916												
RN5RT59A	5.782	5.900	6.018												
RN5RT60A	5.880	6.000	6.120												

T_{opt}=25°C

Supply Current (Standby)			Line Regulation			Input Voltage	Output Voltage Temperature Coefficient		Short Current Limit		CE Input Voltage		CE Input Current						
											"H"	"L"	"H"			"L"			
Istandby (μA)			ΔV _{OUT} /ΔV _{IN} (%/V)			V _{IN} (V)	ΔV _{OUT} /ΔT (ppm/°C)		I _{lim} (mA)		V _{CEH} (V)	V _{CEL} (V)	I _{CEH} (μA)			I _{CEL} (μA)			
Conditions	Typ.	Max.	Conditions	Typ.	Max.	Max.	Conditions	Typ.	Conditions	Typ.	Min.	Max.	Conditions	Typ.	Max.	Conditions	Min.	Typ.	Max.
V _{IN} -V _{OUT} =1.0V	0.1	1.0	I _{OUT} =30mA V _{OUT} +0.5V ≤V _{IN} ≤8V	0.15	0.3	8	I _{OUT} =10mA -40°C ≤T _{opt} ≤85°C	±100	V _{OUT} =0V	30	1.5	0.25	V _{CE} =V _{IN}	0	0.1	V _{CE} =0V	-4.0	-2.0	-0.1

OPERATION

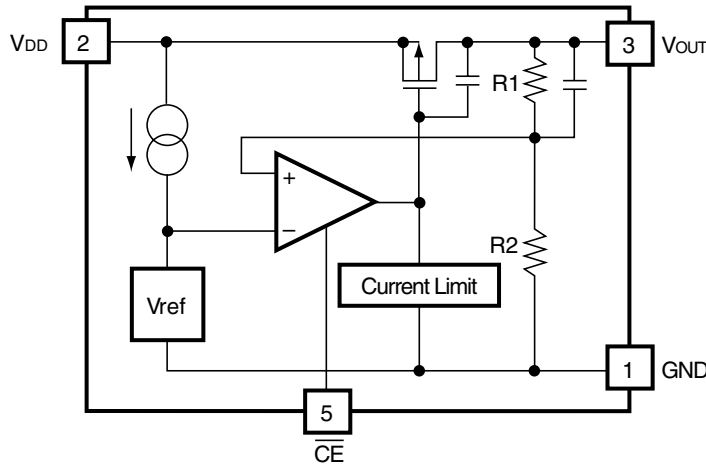

In these ICs, the output voltage V_{OUT} is detected by feed-back registers R1, R2, and the detected output voltage is compared with a reference voltage by the error amplifier, so that a constant voltage is output.

A current limit circuit working for short protection and a chip enable circuit for standby function are included.

TEST CIRCUITS

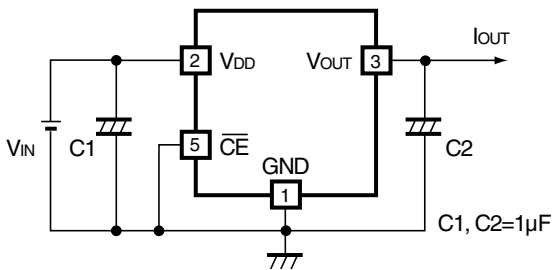

Fig.1 Standard Test Circuit

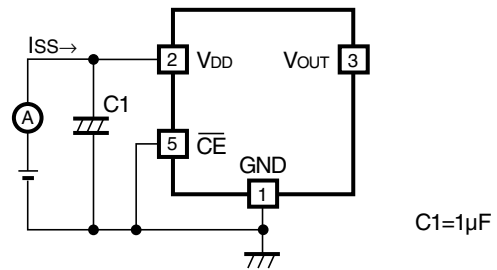

Fig.2 Supply Current Test Circuit

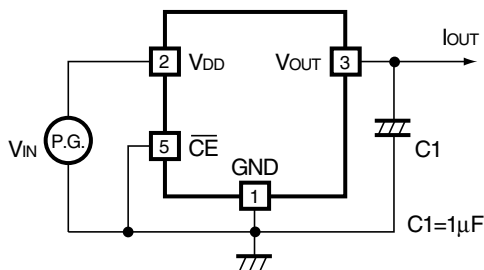
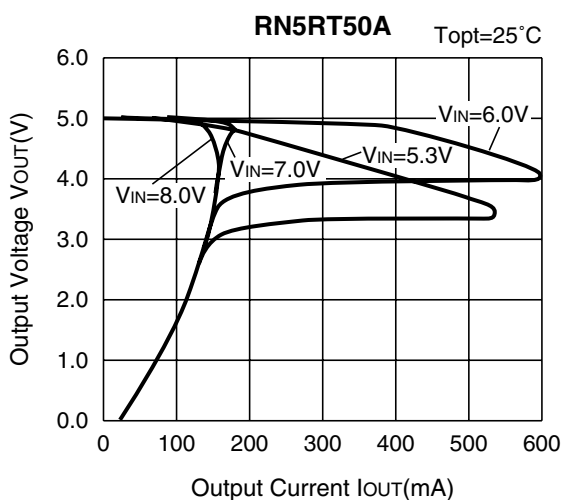
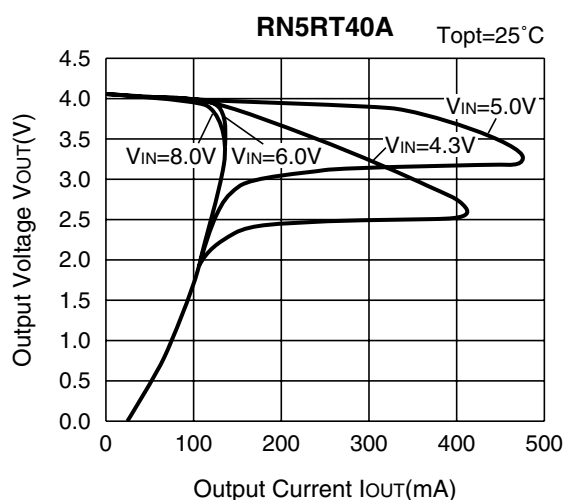
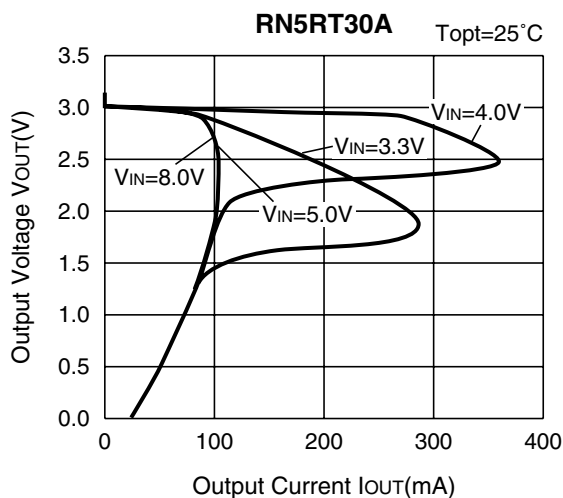

Fig.3 Line Transient Response Test Circuit

TYPICAL CHARACTERISTICS

1) Output Voltage vs. Output Current



2) Output Voltage vs. Input Voltage

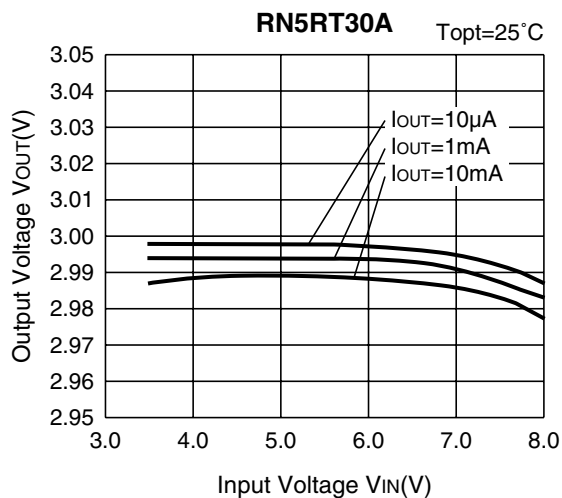
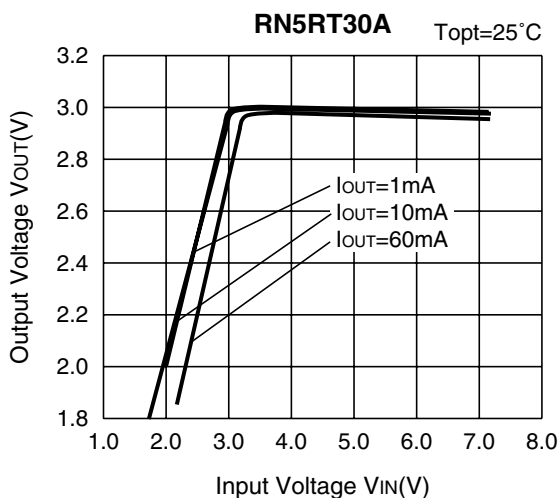

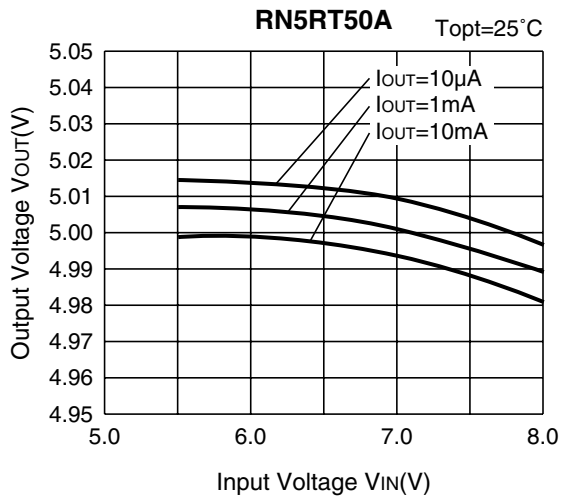
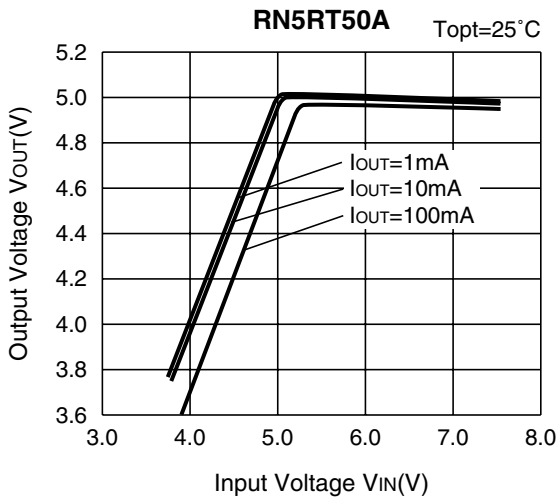
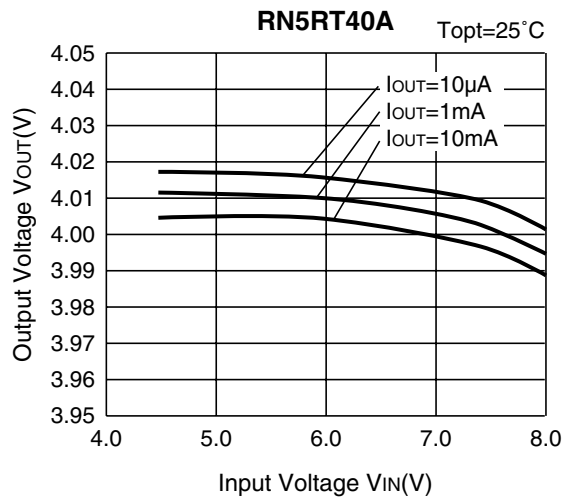
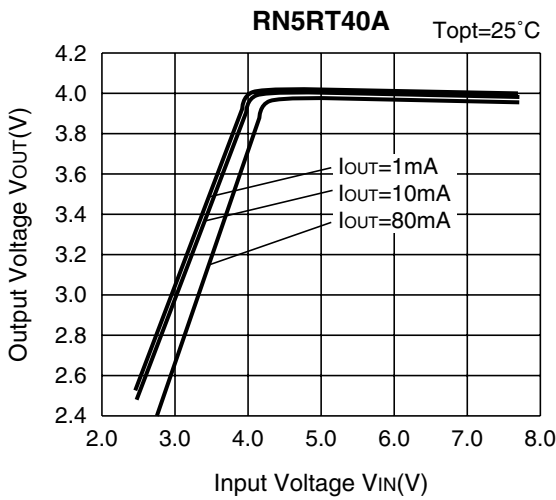

3) Dropout Voltage vs. Output Current

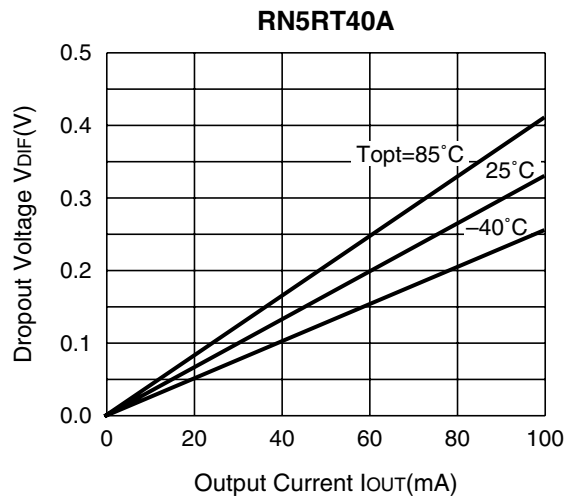
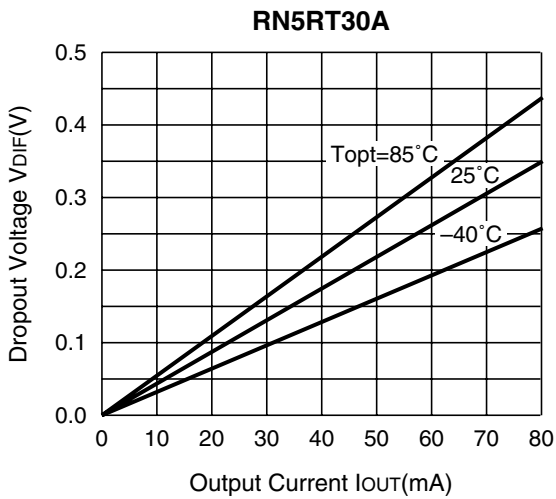

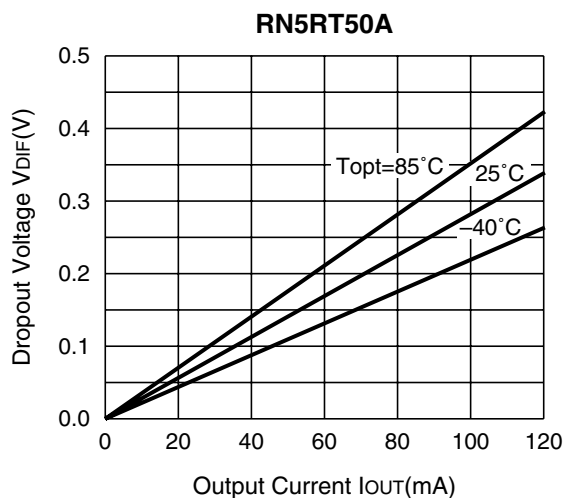

4) Output Voltage vs. Temperature

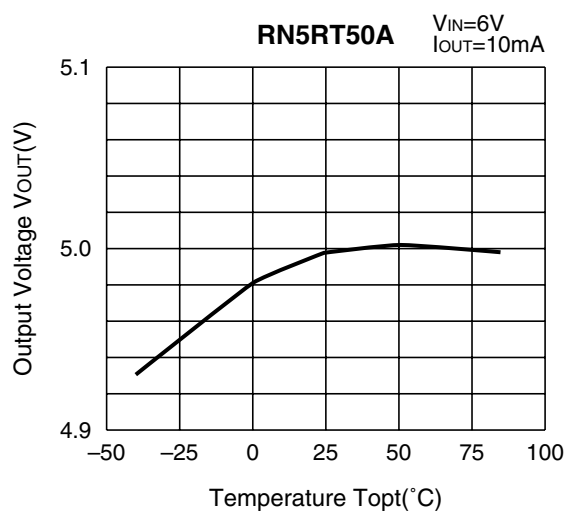
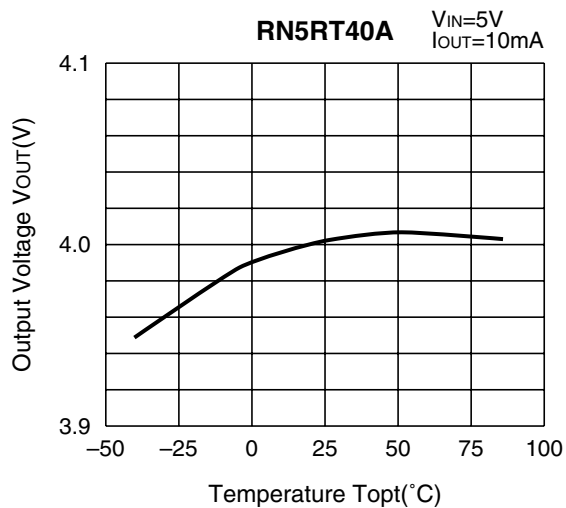
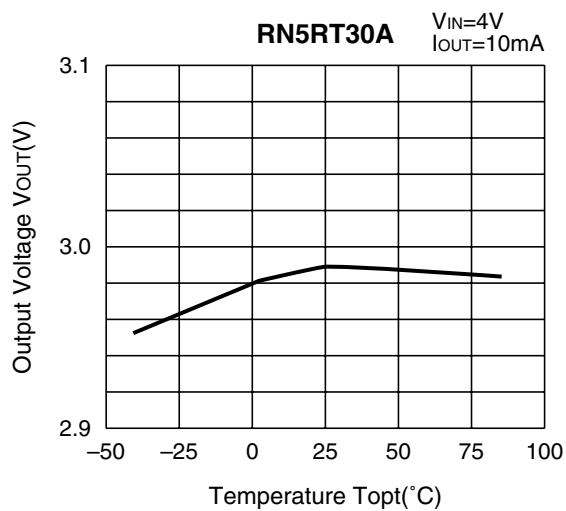

5) Supply Current vs. Input Voltage

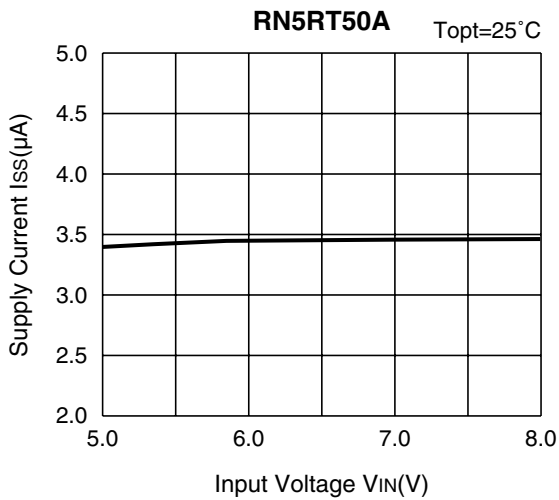
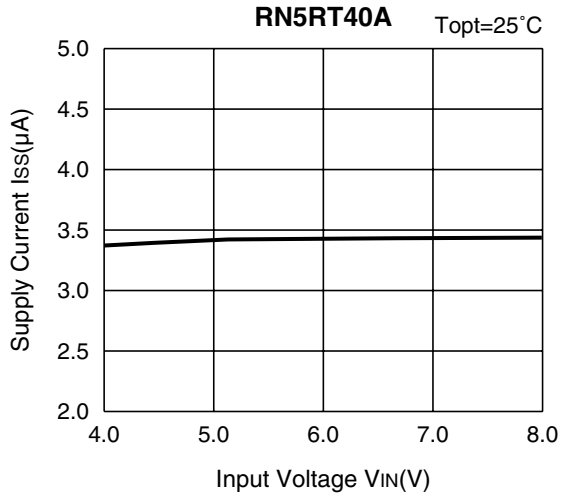
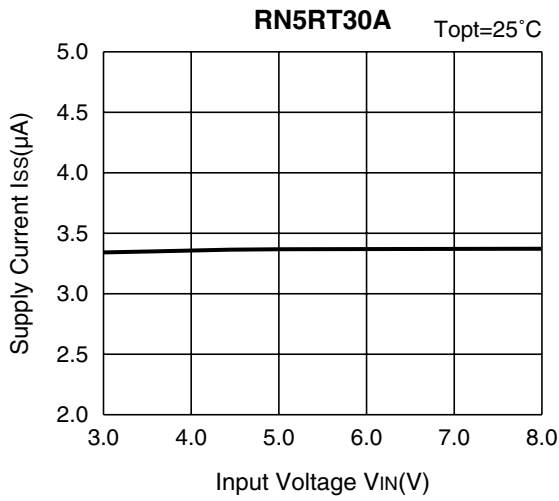

6) Supply Current vs. Temperature

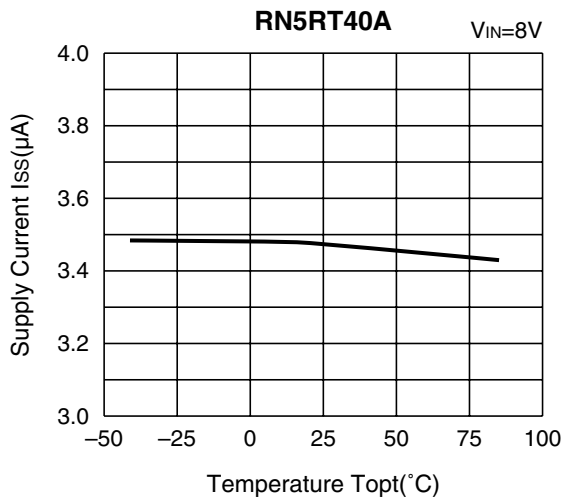
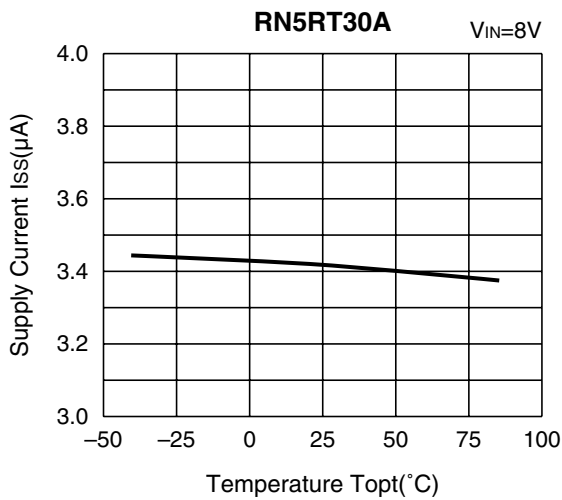

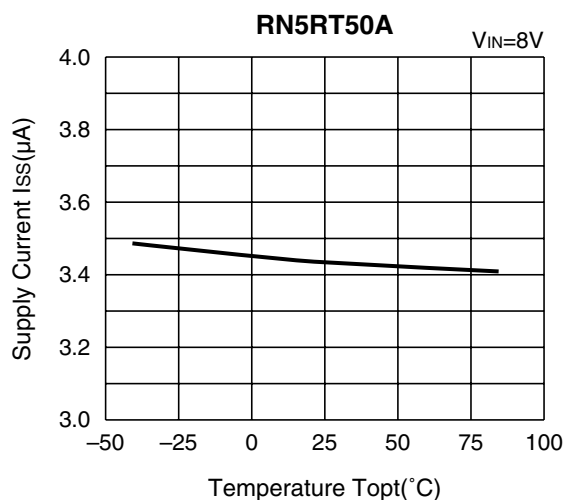

7) Dropout Voltage vs. Set Output Voltage

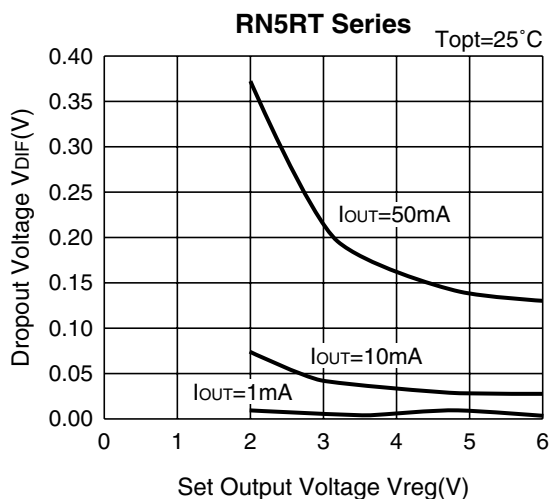

8) Line Transient Response

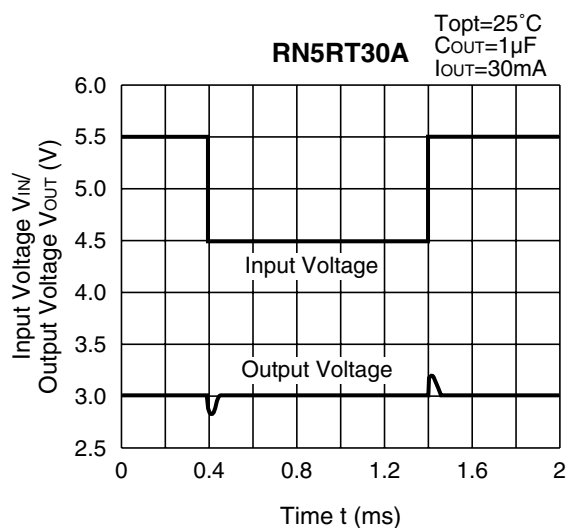
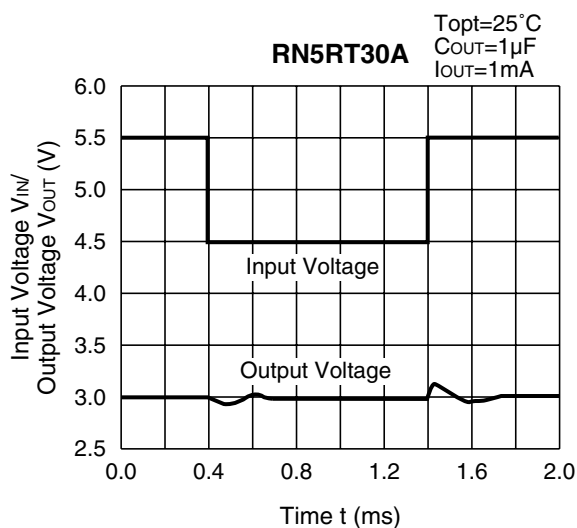

TYPICAL APPLICATION

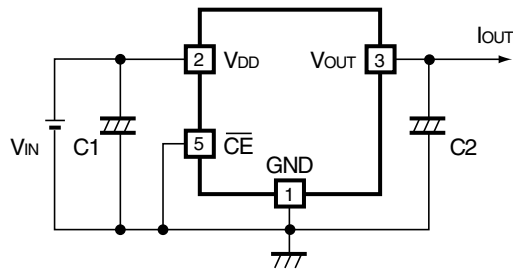

In the RN5RT Series, a constant voltage can be obtained without using capacitor C1 and C2. However, when the wire connected to V_{IN} is long, use a capacitor C1. Transient noise of output voltage occurred due to load deviation can be reduced by using a capacitor C2.

Insert capacitors C1 and C2 with the capacitance of 0.1 μ F to 2.0 μ F between input/output pins and GND pin with minimum wiring.