

Nominal diameter **Withdraw. force** **Rated current** **Contact resistance**

Type **Part No.**

4 mm – 32 A 0.3 mΩ

SLK 425-K/TF **21.5960**
(50 cm)

Highly flexible safety patch cord with 4 mm (.160 in) dia. safety plugs with safety in-line socket 4 mm (.160 in) dia. Plugs machined brass, gold plated with MC®-Multilam™. Matching safety jacks 4 mm (.160 in) dia. MC-Thermoflex wire 2.5 mm² (13 AWG).

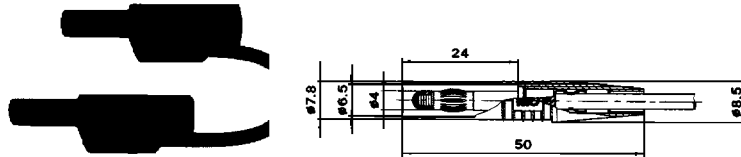

21.5970
(100 cm)

21.5980
(200 cm)

For operating temperatures, see page 27.

Components and ratings:

- Multilam™ plug LS 425-SK # 22.1022
- Insulator (polyamide) KT 425-SK # 22.2300
- Wire HK 2.5-D/TF Thermoflex # 22.0180 (double insul)
- Rated voltage: 1000 V
- Insulation coordination: 6000 V/2
- Test voltage: 3500 V / IEC 3250 V

1:1.5

LS 425-SK

KT 425-SK

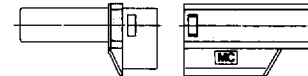

Colors: 1, 2, 4, 5, 6, 9

1:1.3

4 mm – 32 A 0.8 mΩ
0.3 mΩ

SLK425-K/W-TF **21.3640**
(nickel-plated)
(25 cm)

Highly flexible safety patch cord with 4 mm (.160 in) dia. safety plugs with safety in-line socket 4 mm (.160 in) dia. Plugs machined brass, nickel or gold plated with MC®-Multilam™. Matching safety jacks 4 mm (.160 in) dia. Thermoflex-insulated wire 2.5 mm² (13 AWG).

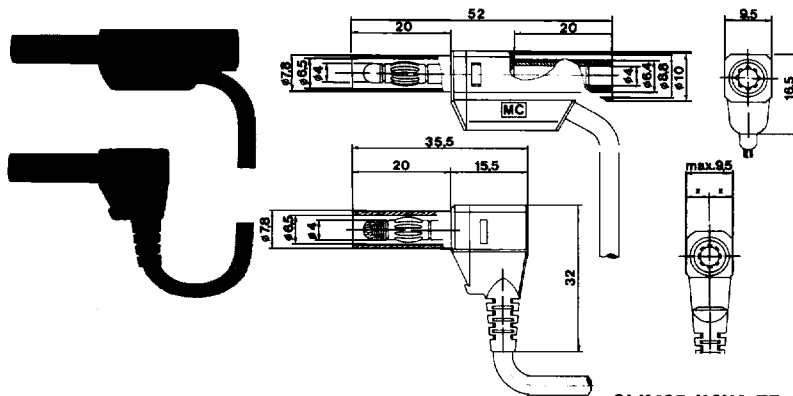

21.3650
(50 cm)

21.3660
(100 cm)

21.3670
(150 cm)

21.3680
(200 cm)

For operating temperatures, see page 27.

Components and ratings for SLK 425-K/W-TF:

- Multilam™ plug LS 425-SK/N # 22.6242
- Multilam™ plug LS 425-SW # 22.1042
- Insulator (polyamide) KT 425-SK # 22.2300
- Insulator (polyamide) KT 425-SW # 22.2370
- Wire HK 2.5-D/TF Thermoflex # 22.0180 (double insul.)
- Rated voltage: 1000 V
- Insulation coordination: 6000 V/2
- Test voltage: 3500 V / IEC 3250 V

SLK425-K/WA-TF

1:1.5

21.6100
(gold-plated)
(25 cm)

Components and ratings for SLK 425-K/WA-TF:

- Multilam™ plug LS 425-SK # 22.1022
- Multilam™ plug LS 425-SW/A # 22.1045
- Insulator (polyamide) KT 425-SK # 22.2300
- Insulator (polyamide) KT 425-SW # 22.2370
- Wire HK 2.5-D/TF Thermoflex # 22.0180 (double insul.)
- Rated voltage: 1000 V
- Insulation coordination: 6000 V/2
- Test voltage: 3500 V / IEC 3250 V

LS 425-SK/N, LS 425-SK

KT 425-SK

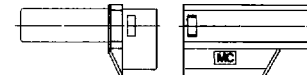
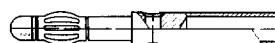

21.6110
(50 cm)

21.6120
(100 cm)

LK 425-SW, LS 425-SW/A

KT 425-SW

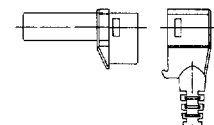
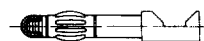

21.6130
(150 cm)

21.6140
(200 cm)

Colors: • Thermoflex: 1, 2, 4, 5, 6, 9

1:1.5

Part No.	Type	Nominal diameter	Withdraw. force	Rated current	Contact resistance
----------	------	------------------	-----------------	---------------	--------------------

21.3360
(nickel plated)
(100 cm)

SLK 425-W

4 mm - 32 A 0.8 mΩ
0.3 mΩ

21.3440
(gold plated)
(100 cm)

SLK 425-W/A

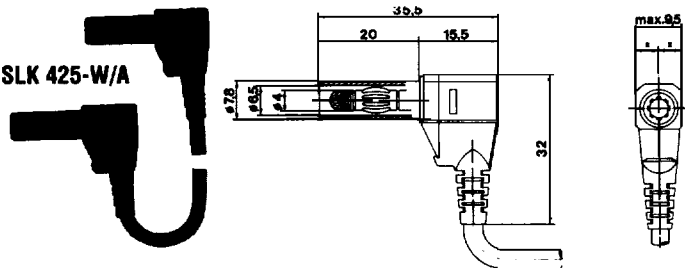

1:1.5

Highly flexible safety patch cord with 4 mm (.160 in) dia. safety plugs. Plugs machined brass, nickel or gold plated with MC®-Multilam™. Matching safety jacks 4 mm (.160 in) dia. PVC insulated wire 2.5 mm² (13 AWG).

For operating temperatures, see page 27.

Components and ratings:

- Multilam™ plug LS 425-SW # 22.1042
- Multilam™ plug LS 425-SW/A # 22.1045
- Insulator (polyamide) KT 425-SW # 22.2370
- Wire HK 2.5-D PVC (double insul.) # 22.0130
- Rated voltage: 1000 V
- Insulation coordination: 6000 V/2
- Test voltage: 4000 V / IEC 3250 V

Colors: • PVC: 0, 1, 2, 4, 5, 6, 9

LS 425-SW, LS 425-SW/A

KT 425-SW

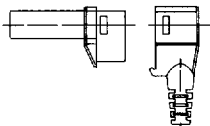
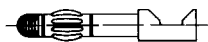

1:1.3

21.3430
(nickel plated)
(100 cm)

SLK 425-W/TF

4 mm - 32 A 0.8 mΩ
0.3 mΩ

21.3480
(gold plated)
(100 cm)

SLK 425-WA/TF

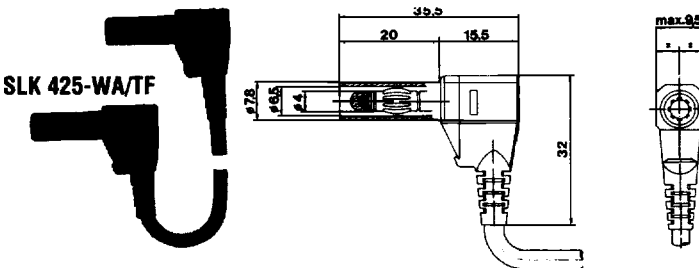

1:1.5

Highly flexible safety patch cord with 4 mm (.160 in) dia. safety plugs with safety in-line socket 4 mm (.160 in) dia. Plugs machined brass, nickel or gold plated with MC®-Multilam™. Matching safety jacks 4 mm (.160 in) dia. Thermoflex insulated wire 2.5 mm² (13 AWG).

For operating temperatures, see page 27.

Components for SLK 425-W/TF (nickel plated):

- Multilam™ plug LS 425-SW # 22.1042
- Insulator (polyamide) KT 425-SW # 22.2370
- Wire HK 2.5-D/TF Thermoflex # 22.0180 (double insul.)
- Rated voltage: 1000 V
- Insulation coordination: 6000 V/2
- Test voltage: 3500 V / IEC 3250 V

Components for SLK 425-WA/TF (gold plated):

- Multilam™ plug LS 425-SW/A # 22.1045
- Insulator (polyamide) KT 425-SW # 22.2370
- Wire HK 2.5-D/TF Thermoflex # 22.0180 (double insul.)
- Rated voltage: 1000 V
- Insulation coordination: 6000 V/2
- Test voltage: 3500 V / IEC 3250 V

Colors: • Thermoflex: 1, 2, 4, 5, 6, 9

LS 425-SW, LS 425-SW/A

KT 425-SW

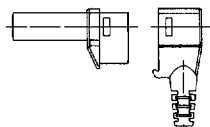
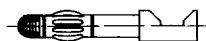

1:1.3

Nominal diameter **Withdraw. force** **Rated current** **Contact resistance**

Type

Part No.

4 mm – 32 A 0.3 mΩ

Highly flexible safety patch cord with 4 mm (.160 in) dia. safety plugs with safety in-line socket 4 mm (.160 in) dia. Plugs machined brass, gold plated with MC®-Multilam™. Matching safety jacks 4 mm (.160 in) dia. PVC or silicone insulated wire 2.5 mm² (13 AWG).

For operating temperatures, see page 27.

Components and ratings for SLK 425-D 90:

- Multilam™ plug LS 425-S # 22.1020
- Multilam™ plug LS 425-SM (screw type) .. # 22.1021
- Insulator (polyamide)KT 425-S-D 90 # 22.2280
- Wire HK 2.5-A PVC # 22.0050
- Rated voltage 750 V
- Insulation coordination: 5000 V/2
- Test voltage: 3000 V

Components for SLK 425-D 90 Sil:

- Multilam™ plug LS 425-S # 22.1020
- Multilam™ plug LS 425-SM (screw type) .. # 22.1021
- Insulator (polyamide)KT 425-S-D 90 # 22.2280
- Wire HK 2.5-Sil # 22.0080
- Rated voltage 500 V
- Insulation coordination: 4000 V/2
- Test voltage: 2000 V

Colors: • PVC: 0 - 9 • Sil: 1, 2, 4, 5, 6

4 mm – 19 A 0.3 mΩ

Highly flexible safety patch cord with 4 mm (.160 in) dia. safety plugs. Plugs machined brass, gold plated with MC®-Multilam™. Matching safety jacks 4 mm (.160 in) dia. Silicone-insulated wire 1.0 mm² (17 AWG).

For operating temperatures, see page 27.

Components and ratings for SLK 410-L:

- Multilam plug LS 425-SL # 22.1025
- Insulator (polyamide) KT 425-SL # 22.2260
- Wire HK 1-D (double insul.) # 22.0150
- Rated voltage 1500 V
- Insulation coordination 8000 V/2
- Test voltage 4350 V

Components and rating for SLK 410-L Sil:

- Multilam plug LS 425-SL # 22.1025
- Insulator (polyamide) KT 425-SL # 22.2260
- Wire HK 1 Sil/1000 # 22.0170
- Rated voltage 1500 V
- Insulation coordination 8000 V/2
- Test voltage 4350 V

Colors: • PVC: 1, 4 • Sil: 1, 2, 4

Assembly instructions available.

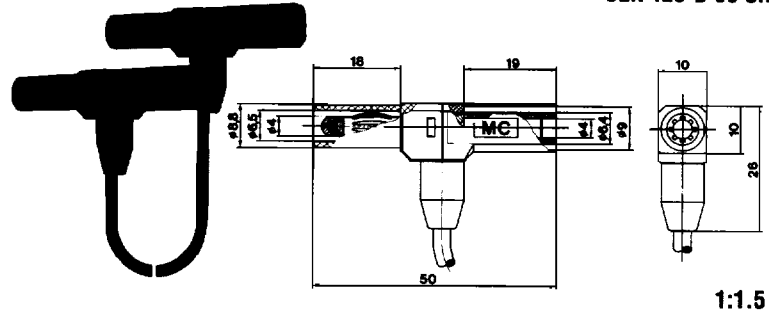

SLK 425-D 90
SLK 425-D 90 Sil

21.5110
(Sil) 21.5170
(25 cm)

21.5120
(Sil) 21.5180
(50 cm)

21.5130
(Sil) 21.5190
(75 cm)

21.5140
(Sil) 21.5200
(100 cm)

LS 425-S

KT 425-S-D90

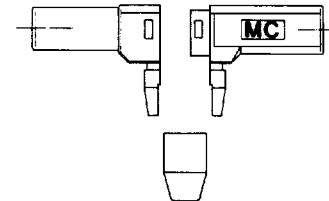
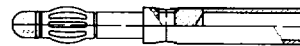

LS 425-SM



1:1.5

1:1

21.5150
(Sil) 21.5210
(150 cm)

21.5160
(Sil) 21.5220
(200 cm)

SLK 410-L
SLK 410-L Sil

21.6150
21.3560 (Sil)
(25 cm)

21.6160
21.3570 (Sil)
(50 cm)

21.6170
21.3580 (Sil)
(75 cm)

21.6180
21.3590 (Sil)
(100 cm)

21.6190
21.3600 (Sil)
(150 cm)

21.6200
21.3610 (Sil)
(200 cm)

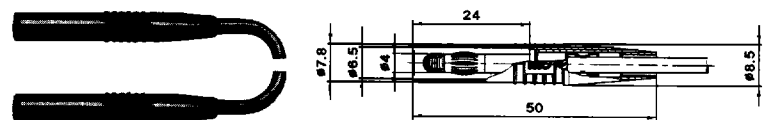

LS 425-SL

KT 425-SL

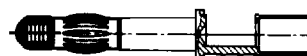

1:1.5

1:1

Part No.	Type	Nominal diameter	Withdraw. force	Rated current	Contact resistance
----------	------	------------------	-----------------	---------------	--------------------

21.3390
(nickel plated)
(100 cm)

SLK 425-L/W



21.3490
(gold plated)
(100 cm)

SLK 425-L/WA

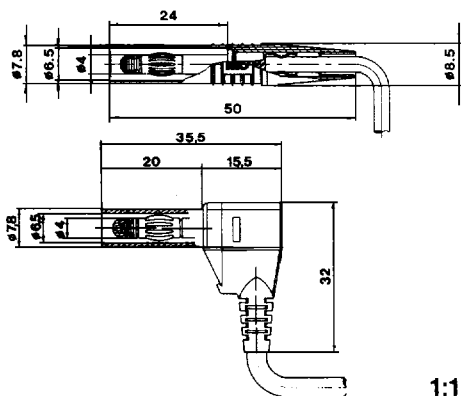

4 mm - 32 A 0.8 mΩ
0.3 mΩ

Highly flexible safety patch cord with 4 mm (.160 in) dia. safety plugs. Plugs machined brass, nickel or gold plated with MC®-Multilam™. Matching safety jacks 4 mm (.160 in) dia. PVC insulated wire 2.5 mm² (13 AWG). For operating temperatures, see page 27.

Components for SLK 425-L/W (nickel plated):

- Multilam™ plug LS 425-SL/N # 22.1032
- Multilam™ plug LS 425-S/W # 22.1042
- Insulator (polyamide) KT 425-SL # 22.2260
- Insulator (polyamide) KT 425-SW # 22.2370
- Wire HK 2.5-D PVC (double insul.) # 22.0130
- Rated voltage 1000 V
- Insulation coordination 6000 V/2
- Test voltage 4000 V / IEC 3250 V

LS 425-SL/N, LS 425-SL

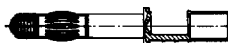

KT 425-SL



LS 425-SW, LS 425-SW/A

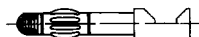

KT 425-SW

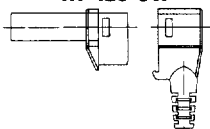

1:1.5

1:1.3

Components for SLK 425-L/WA (gold plated):

- Multilam™ plug LS 425-SL # 22.1025
 - Multilam™ plug LS 425-SW/A # 22.1045
 - Insulator (polyamide) KT 425-SL # 22.2260
 - Insulator (polyamide) KT 425-SW # 22.2370
 - Wire HK 2.5-D PVC (double insul.) # 22.0130
 - Rated voltage 1000 V
 - Insulation coordination 6000 V/2
 - Test voltage 4000 V / IEC 3250 V
- Colors: 1, 2, 4

21.6230
(200 cm)

SLK 418-L/6kV

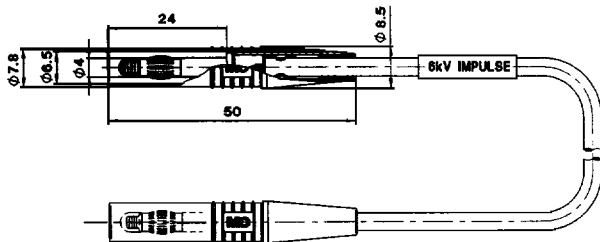

4 mm - 16 A 0.3 mΩ

Highly flexible safety patch cord with 4 mm (.160 in) dia. safety plugs, non-stacking. Plugs, machined brass, gold plated with MC®-Multilam™. Matching safety sockets and jacks 4 mm (.160 in) dia. PVC insulated 18 AWG wire.

For operating temperatures, see page 27.

Components and ratings:

- Multilam™ plug LS 425-SL # 22.1025
- Insulator (polyamide) KT 425-SL # 22.2260
- Label sleeve # 22.7120
- Wire HK 18-H PVC # 22.0110
- Rated pulse voltage: 6000 V, 1.2/50µs
- Test voltage: 6000 V, 1.2/50µs

LS 425-SL

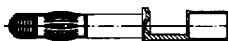

KT 425-SL



KT-6kV

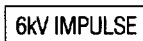

1:1.5

1:1.3

Colors: 1, 4

0 - green/yellow 1 - red 2 - blue 3 - white 4 - black 5 - yellow 6 - green 7 - brown 8 - gray 9 - violet