



5SDD 41H4000

Old part no. DV 889-4100-40

Rectifier Diode

Properties

- § Industry standard housing
- § Suitable for parallel operation
- § High operating temperature
- § Low forward voltage drop

Key Parameters

V_{RRM}	=	4 000	V
I_{FAVm}	=	4 136	A
I_{FSM}	=	46 000	A
V_{TO}	=	0.905	V
r_T	=	0.109	mΩ

Types

	V_{RRM}
5SDD 41H4000	4 000 V
5SDD 41H3800	3 800 V
Conditions:	$T_j = -40 \div 160 \text{ }^\circ\text{C}$, half sine waveform, $f = 50 \text{ Hz}$

Mechanical Data

F_m	Mounting force	50 ± 5 kN
m	Weight	0.9 kg
D_s	Surface creepage distance	40 mm
D_a	Air strike distance	20 mm

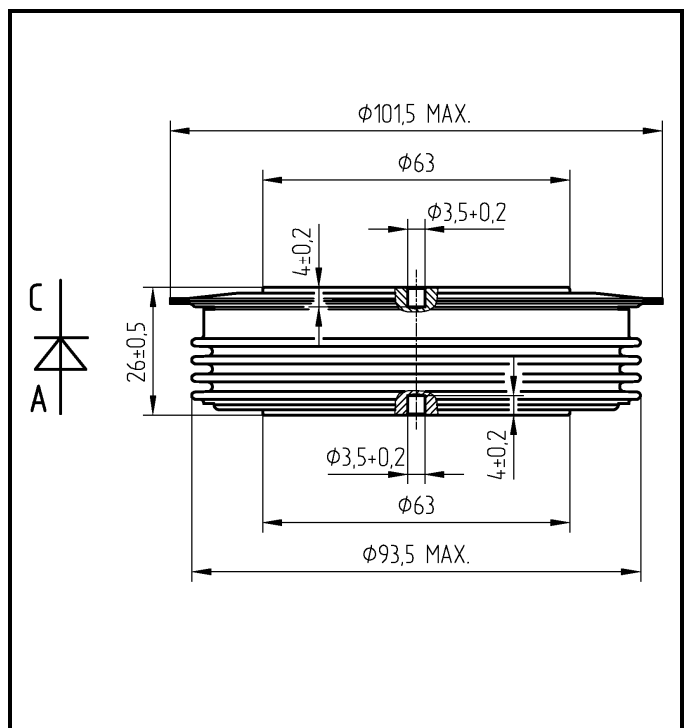

Fig. 1 Case



ABB s.r.o.

Novodvorska 1768/138a, 142 21 Praha 4, Czech Republic

tel.: +420 261 306 250, <http://www.abb.com/semiconductors>

Maximum Ratings			Maximum Limits	Unit
V_{RRM}	Repetitive peak reverse voltage $T_j = -40 \div 160 \text{ }^\circ\text{C}$	5SDD 41H4000 5SDD 41H3800	4 000 3 800	V
I_{FAVm}	Average forward current $T_c = 85 \text{ }^\circ\text{C}$		4 136	A
I_{FRMS}	RMS forward current $T_c = 85 \text{ }^\circ\text{C}$		6 497	A
I_{RRM}	Repetitive reverse current $V_R = V_{RRM}$		100	mA
I_{FSM}	Non repetitive peak surge current $V_R = 0 \text{ V, half sine pulse}$	$t_p = 8.3 \text{ ms}$	49 000	A
		$t_p = 10 \text{ ms}$	46 000	A
I^2t	Limiting load integral $V_R = 0 \text{ V, half sine pulse}$	$t_p = 8.3 \text{ ms}$	10 020 000	A²s
		$t_p = 10 \text{ ms}$	10 580 000	A²s
$T_{jmin} - T_{jmax}$	Operating temperature range		-40 \div 160	$^\circ\text{C}$
T_{STG}	Storage temperature range		-40 \div 160	$^\circ\text{C}$

Unless otherwise specified $T_j = 160 \text{ }^\circ\text{C}$

Characteristics		Value			Unit
		<i>min</i>	<i>typ</i>	<i>max</i>	
V_{T0}	Threshold voltage			0.905	V
r_T	Forward slope resistance $I_{F1} = 6\,283 \text{ A, } I_{F2} = 18\,850 \text{ A}$			0.109	mW
V_{FM}	Maximum forward voltage $I_{FM} = 4\,000 \text{ A}$			1.310	V
Q_{rr}	Recovered charge	$V_R = 100 \text{ V,}$ $I_{FM} = 2000 \text{ A,}$ $di_F/dt = -30 \text{ A}/\mu\text{s}$		4 600	μC
I_{rrM}	Reverse recovery maximum current			340	A
t_{rr}	Reverse recovery time			26	μs

Unless otherwise specified $T_j = 160 \text{ }^\circ\text{C}$

Thermal Parameters			Value	Unit
R_{thjc}	Thermal resistance junction to case	double side cooling	8.0	K/kW
		anode side cooling	14.5	
		cathode side cooling	18.0	
R_{thch}	Thermal resistance case to heatsink	double side cooling	2.5	K/kW
		single side cooling	5.0	

Transient Thermal Impedance

Analytical function for transient thermal impedance

$$Z_{thjc} = \sum_{i=1}^4 R_i (1 - \exp(-t / \tau_i))$$

Conditions:

$F_m = 50 \pm 5$ kN, Double side cooled

Correction for periodic waveforms

180° sine:	1.0 K/kW
120° sine:	1.5 K/kW
60° sine:	2.5 K/kW
180° rectangular:	0.9 K/kW
120° rectangular:	1.5 K/kW
60° rectangular:	2.5 K/kW

i	1	2	3	4
τ_i (s)	0.4406	0.1045	0.0092	0.0022
R_i (K/kW)	4.533	2.255	0.868	0.345

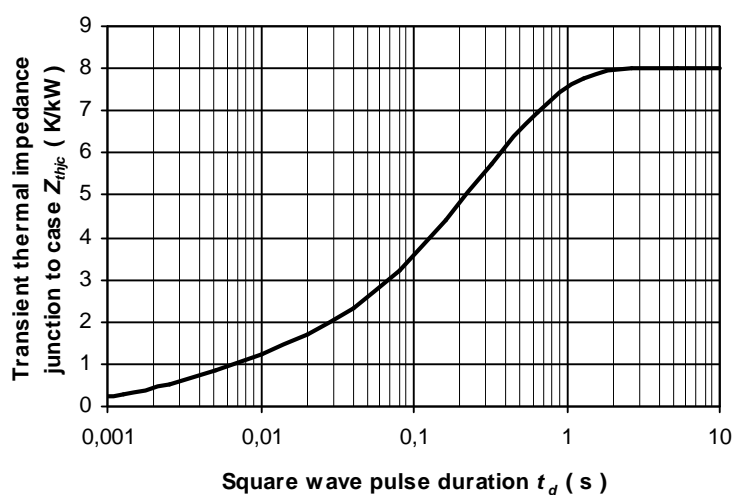

Fig. 2 Dependence transient thermal impedance junction to case on square pulse

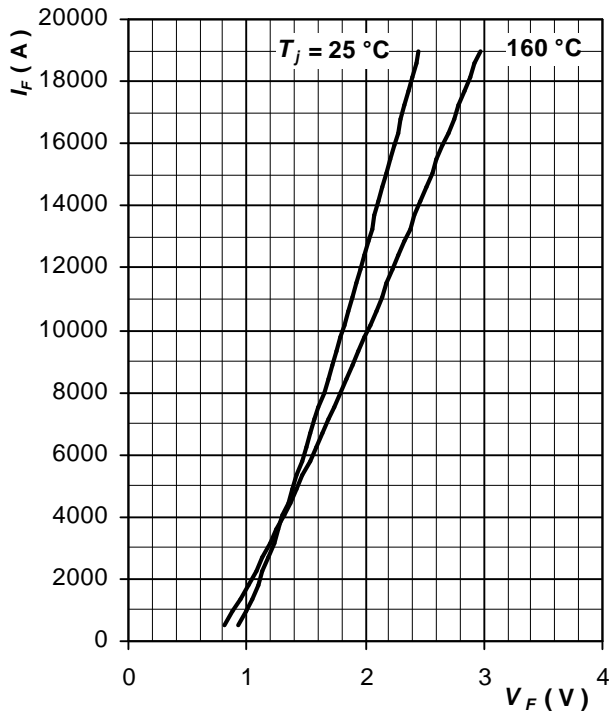

Fig. 3 Maximum forward voltage drop characteristics

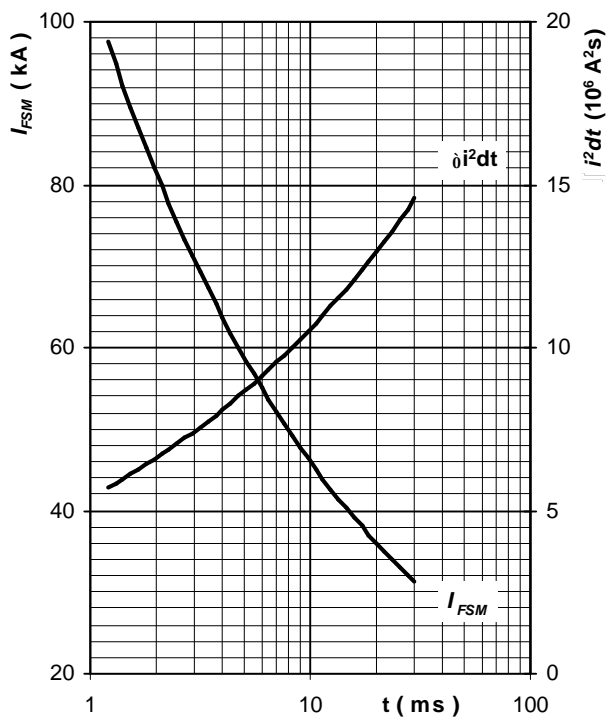

Fig. 4 Surge forward current vs. pulse length, half sine wave, single pulse, $V_R = 0\text{ V}$, $T_j = T_{jmax}$

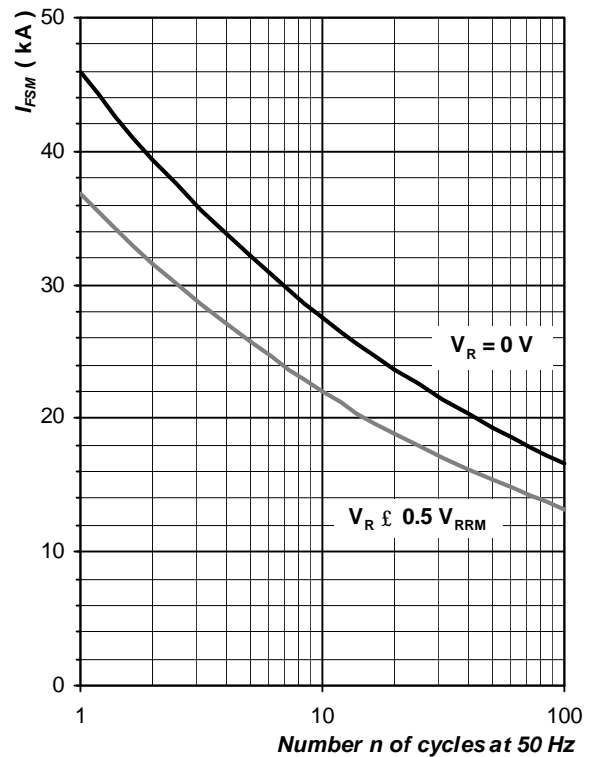

Fig. 5 Surge forward current vs. number of pulses, half sine wave, $T_j = T_{jmax}$

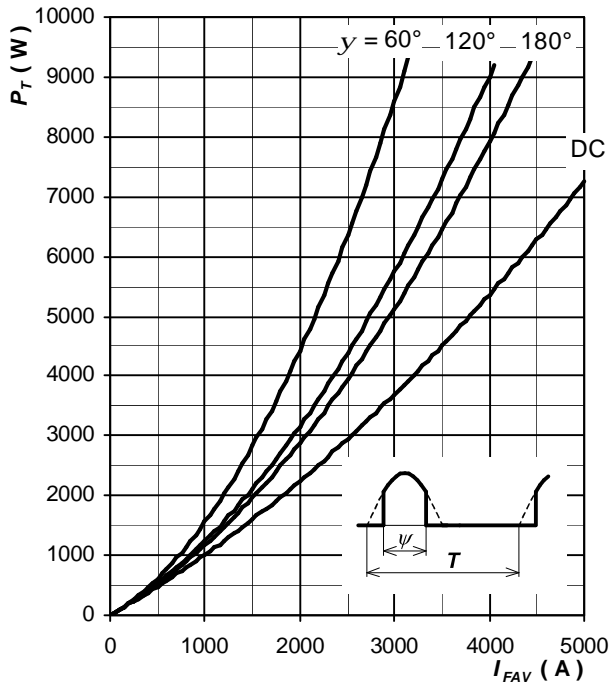

Fig. 6 Forward power loss vs. average forward current, sine waveform, $f = 50$ Hz, $T = 1/f$

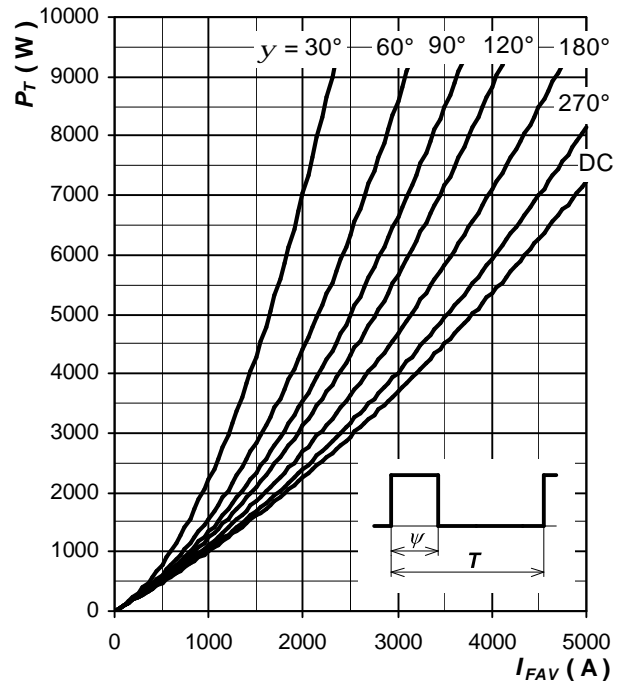

Fig. 7 Forward power loss vs. average forward current, square waveform, $f = 50$ Hz, $T = 1/f$

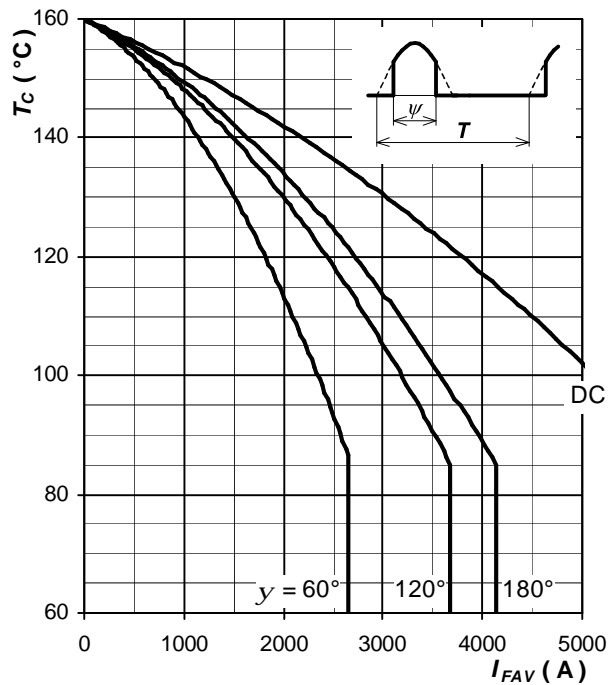

Fig. 8 Max. case temperature vs. aver. forward current, sine waveform, $f = 50$ Hz, $T = 1/f$

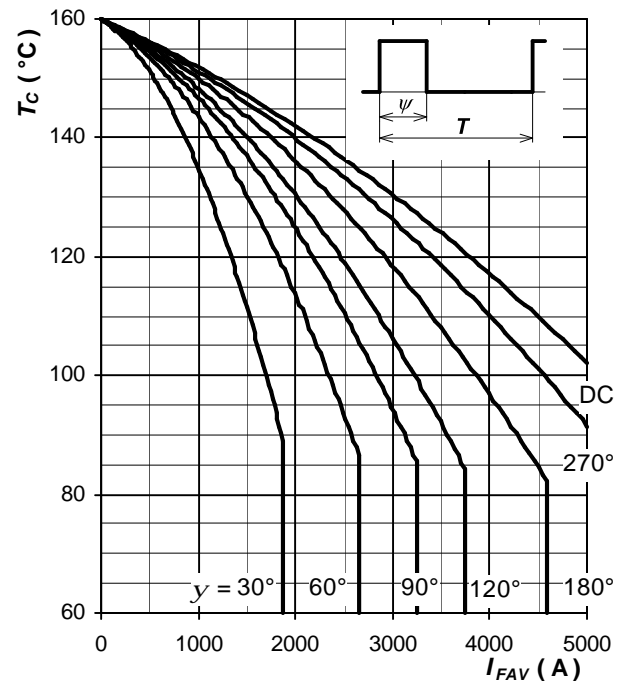

Fig. 9 Max. case temperature vs. aver. forward current, square waveform, $f = 50$ Hz, $T = 1/f$

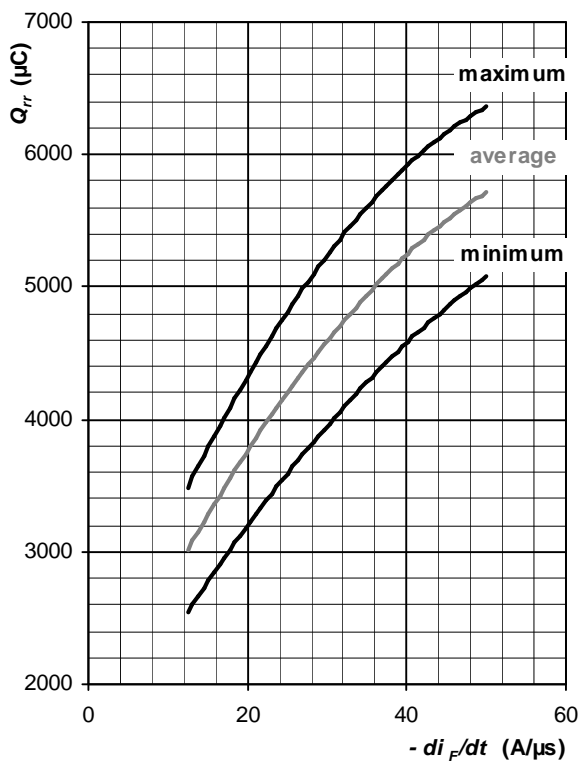

Fig. 10

Recovered charge Q_{rr}
vs. rate of fall forward current di_F/dt , trapezoid pulse,
 $I_{FM} = 2\ 000\ A$, $V_R = 100\ V$, $T_j = T_{jmax}$

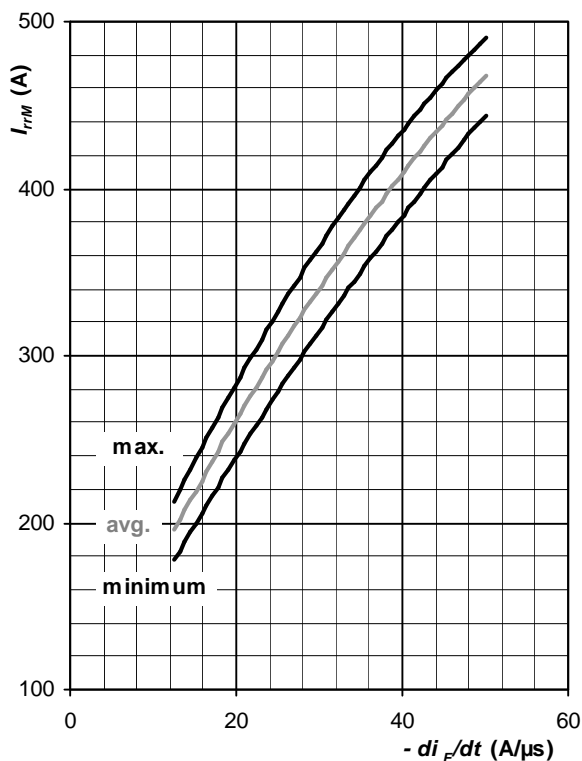

Fig. 11 Reverse recovery maximum current I_{rrm}
vs. rate of fall forward current di_F/dt ,
trapezoid pulse, $I_{FM} = 2\ 000\ A$,
 $V_R = 100\ V$, $T_j = T_{jmax}$

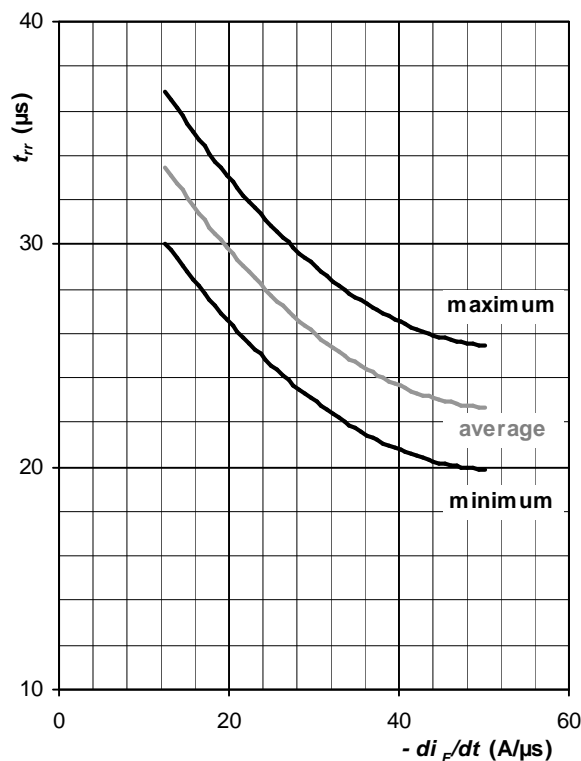

Fig. 12 Reverse recovery time t_{rr} vs. rate of fall
forward current di_F/dt , trapezoid pulse,
 $I_{FM} = 2\ 000\ A$, $V_R = 100\ V$, $T_j = T_{jmax}$

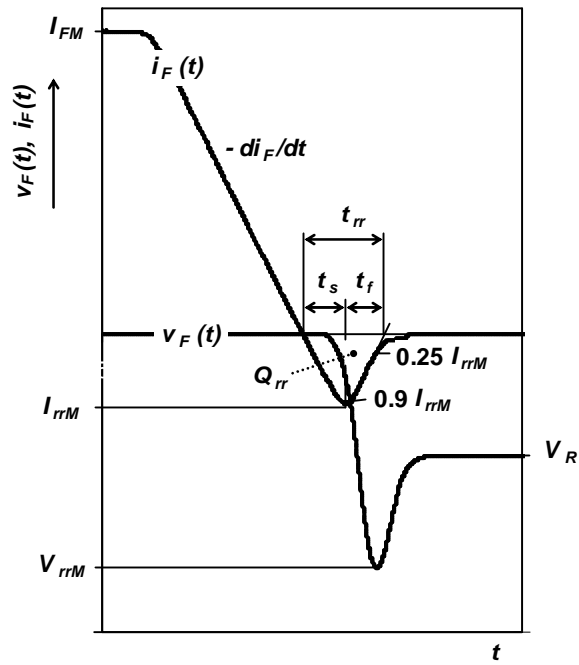

Fig. 13 Typical waveforms and definition of symbols
at reverse recovery of a diode

Notes: