

# IS61SF632A

## 32K x 32 SYNCHRONOUS FLOW-THROUGH FAST STATIC RAM

ADVANCE INFORMATION  
MARCH 1997

### FEATURES

- Fast access time: 9 ns, 10 ns
- Internal self-timed write cycle
- Individual Byte Write Control and Global Write
- Clock controlled, registered address, data and control
- Pentium™ or linear burst sequence control using MODE input
- Three chip enables for simple depth expansion and address pipelining
- Common data inputs and data outputs
- Power-down control by ZZ input
- JEDEC 100-Pin TQFP and PQFP package
- Single +3.3V power supply
- Two Clock enables and one Clock disable to eliminate multiple bank bus contention.
- Control pins mode upon power-up:
  - FT in pipeline mode
  - MODE in interleave burst mode
  - ZZ in normal operation mode
 These control pins can be connected to GND<sub>Q</sub> or VCC<sub>Q</sub> to alter their power-up state

### DESCRIPTION

The *ISSI* IS61SF632A is a high-speed, low-power synchronous static RAM designed to provide a burstable, high-performance, secondary cache for the i486™, Pentium™, 680X0™, and PowerPC™ microprocessors. It is organized as 32,768 words by 32 bits, fabricated with *ISSI*'s advanced CMOS technology. The device integrates a 2-bit burst counter, high-speed SRAM core, and high-drive capability outputs into a single monolithic circuit. All synchronous inputs pass through registers controlled by a positive-edge-triggered single clock input.

Write cycles are internally self-timed and are initiated by the rising edge of the clock input. Write cycles can be from one to four bytes wide as controlled by the write control inputs.

Separate byte enables allow individual bytes to be written.  $\overline{BW1}$  controls DQ1-DQ8,  $\overline{BW2}$  controls DQ9-DQ16,  $\overline{BW3}$  controls DQ17-DQ24,  $\overline{BW4}$  controls DQ25-DQ32, conditioned by  $\overline{BWE}$  being LOW. A LOW on  $\overline{GW}$  input would cause all bytes to be written.

Bursts can be initiated with either  $\overline{ADSP}$  (Address Status Processor) or  $\overline{ADSC}$  (Address Status Cache Controller) input pins. Subsequent burst addresses can be generated internally by the IS61SF632A and controlled by the  $\overline{ADV}$  (burst address advance) input pin.

Asynchronous signals include output enable ( $\overline{OE}$ ), sleep mode input (ZZ), clock (CLK) and burst mode input (MODE). A HIGH input on the ZZ pin puts the SRAM in the power-down state. When ZZ is pulled LOW (or no connect), the SRAM normally operates after three cycles of the wake-up period. A LOW input, i.e., GND<sub>Q</sub>, on MODE pin selects LINEAR Burst. A VCC<sub>Q</sub> (or no connect) on MODE pin selects INTERLEAVED Burst.

**BLOCK DIAGRAM**

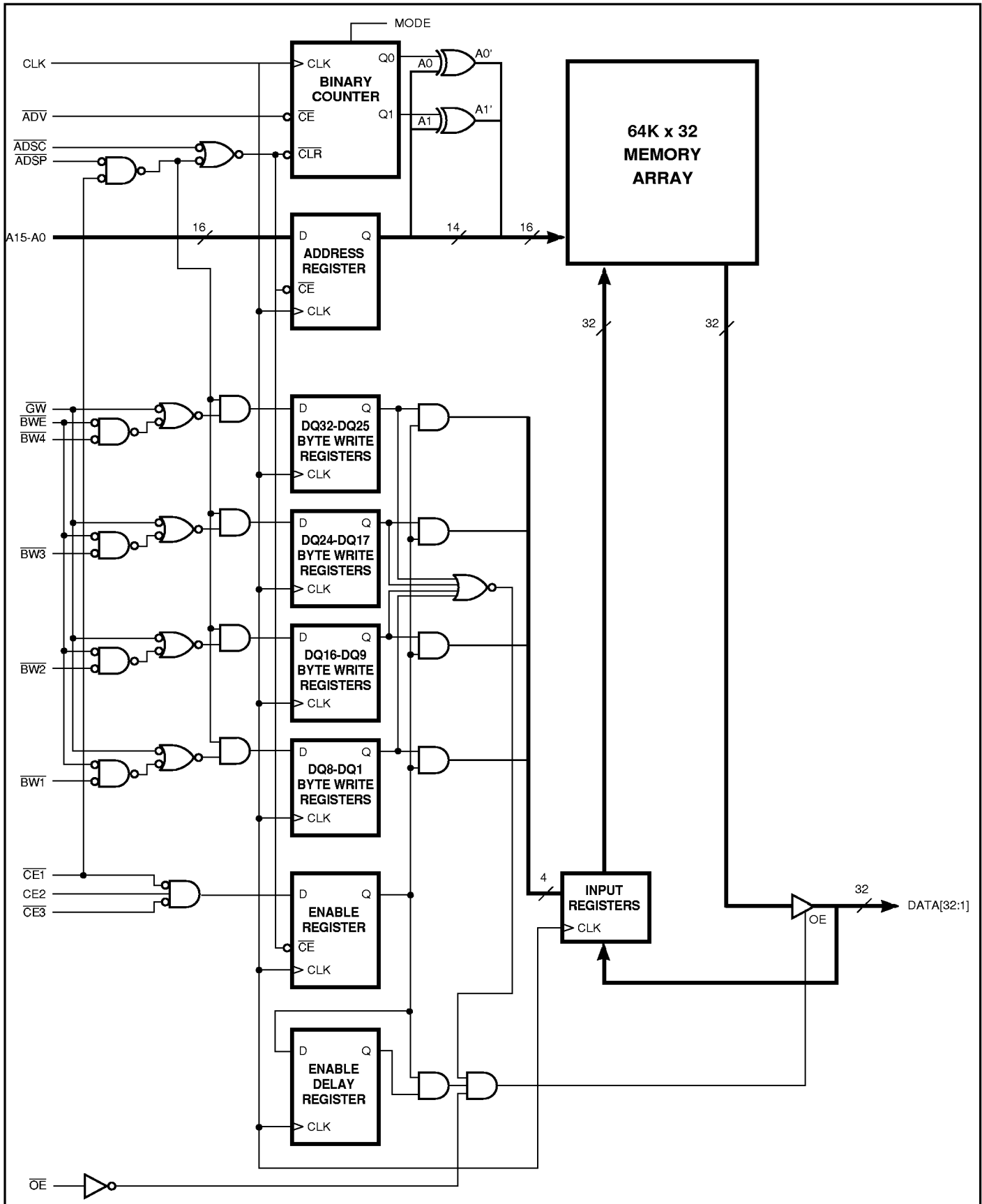

## PIN CONFIGURATION

### 100-Pin TQFP and PQFP (Top View)

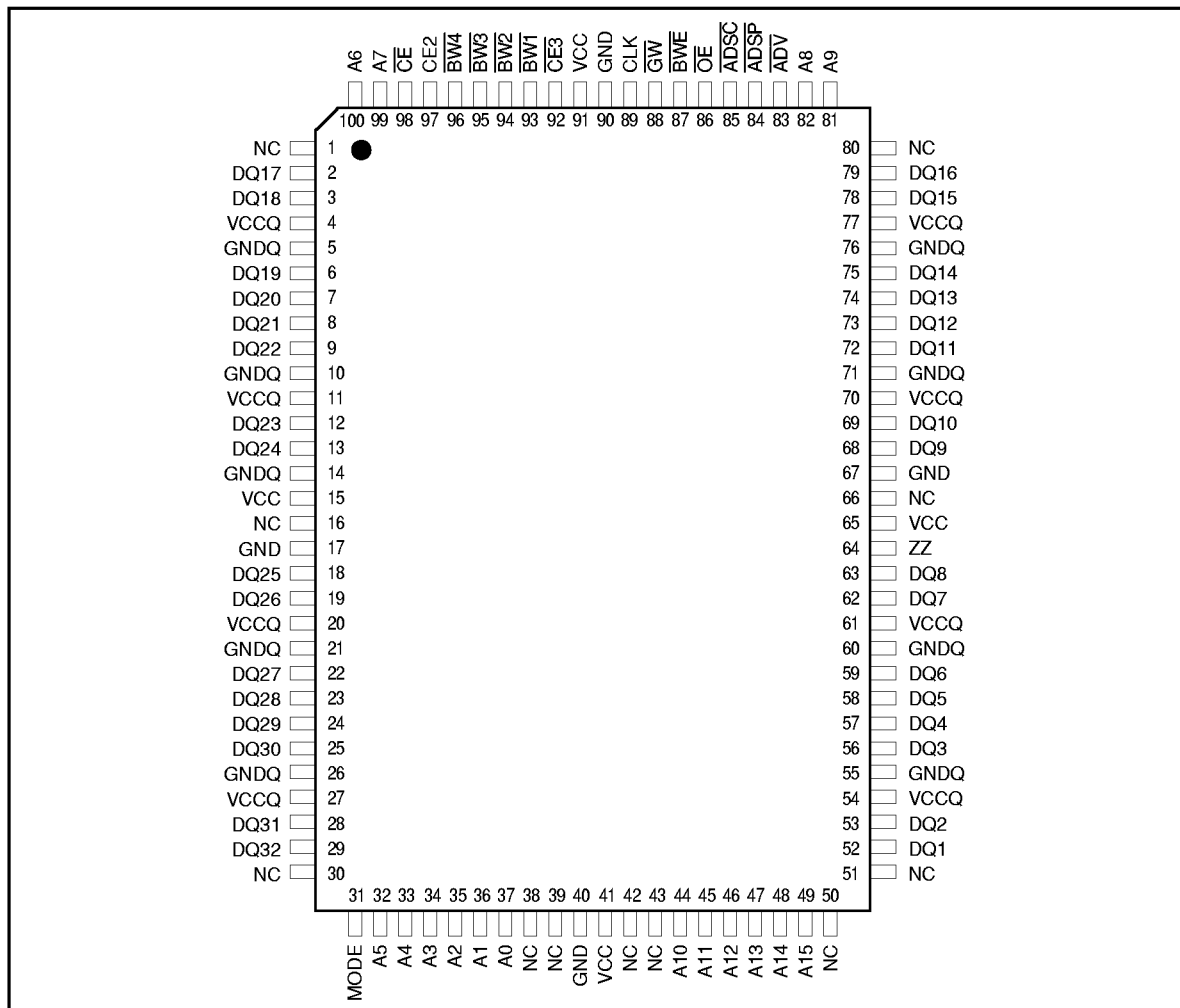

## PIN DESCRIPTIONS

A0-A14	Address Inputs	DQ1-DQ32	Data Input/Output
CLK	Clock	ZZ	Sleep Mode
$\overline{\text{ADSP}}$	Processor Address Status	MODE	Burst Sequence Mode
$\overline{\text{ADSC}}$	Controller Address Status	V <sub>CC</sub>	+3.3V Power Supply
$\overline{\text{ADV}}$	Burst Address Advance	GND	Ground
$\overline{\text{BW1-BW4}}$	Synchronous Byte Write Enable	V <sub>CCQ</sub>	Isolated Output Buffer Supply: +3.3V
$\overline{\text{BWE}}$	Byte Write Enable	GND <sub>Q</sub>	Isolated Output Buffer Ground
$\overline{\text{GW}}$	Global Write Enable		
$\overline{\text{CE1, CE2, CE3}}$	Synchronous Chip Enable		
$\overline{\text{OE}}$	Output Enable		

## TRUTH TABLE

OPERATION	ADDRESS USED	$\overline{CE1}$	CE2	$\overline{CE3}$	$\overline{ADSP}$	$\overline{ADSC}$	$\overline{ADV}$	$\overline{WRITE}$	$\overline{OE}$	DQ
Deselected, Power-down	None	H	X	X	X	L	X	X	X	High-Z
Deselected, Power-down	None	L	L	X	L	X	X	X	X	High-Z
Deselected, Power-down	None	L	X	H	L	X	X	X	X	High-Z
Deselected, Power-down	None	L	L	X	H	L	X	X	X	High-Z
Deselected, Power-down	None	L	X	H	H	L	X	X	X	High-Z
Read Cycle, Begin Burst	External	L	H	L	L	X	X	X	L	Q
Read Cycle, Begin Burst	External	L	H	L	L	X	X	X	H	High-Z
Write Cycle, Begin Burst	External	L	H	L	H	L	X	L	X	D
Read Cycle, Begin Burst	External	L	H	L	H	L	X	H	L	Q
Read Cycle, Begin Burst	External	L	H	L	H	L	X	H	H	High-Z
Read Cycle, Continue Burst	Next	X	X	X	H	H	L	H	L	Q
Read Cycle, Continue Burst	Next	X	X	X	H	H	L	H	H	High-Z
Read Cycle, Continue Burst	Next	H	X	X	X	H	L	H	L	Q
Read Cycle, Continue Burst	Next	H	X	X	X	H	L	H	H	High-Z
Write Cycle, Continue Burst	Next	X	X	X	H	H	L	L	X	D
Write Cycle, Continue Burst	Next	H	X	X	X	H	L	L	X	D
Read Cycle, Suspend Burst	Current	X	X	X	H	H	H	H	L	Q
Read Cycle, Suspend Burst	Current	X	X	X	H	H	H	H	H	High-Z
Read Cycle, Suspend Burst	Current	H	X	X	X	H	H	H	L	Q
Read Cycle, Suspend Burst	Current	H	X	X	X	H	H	H	H	High-Z
Write Cycle, Suspend Burst	Current	X	X	X	H	H	H	L	X	D
Write Cycle, Suspend Burst	Current	H	X	X	X	H	H	L	X	D

## Notes:

- All inputs except  $\overline{OE}$  must meet setup and hold times for the Low-to-High transition of clock (CLK).
- Wait states are inserted by suspending burst.
- X means don't care.  $\overline{WRITE}=L$  means any one or more byte write enable signals ( $\overline{BW1}-\overline{BW4}$ ) and  $\overline{BWE}$  are LOW or  $\overline{GW}$  is LOW.  $\overline{WRITE}=H$  means all byte write enable signals are HIGH.
- For a Write operation following a Read operation,  $\overline{OE}$  must be HIGH before the input data required setup time and held HIGH throughout the input data hold time.
- $\overline{ADSP}$  LOW always initiates an internal READ at the Low-to-High edge of clock. A WRITE is performed by setting one or more byte write enable signals and  $\overline{BWE}$  LOW or  $\overline{GW}$  LOW for the subsequent L-H edge of clock.

## PARTIAL TRUTH TABLE

FUNCTION	$\overline{GW}$	$\overline{BWE}$	$\overline{BW1}$	$\overline{BW2}$	$\overline{BW3}$	$\overline{BW4}$
READ	H	H	X	X	X	X
READ	H	X	H	H	H	H
WRITE Byte 1	H	L	L	H	H	H
WRITE All Bytes	X	L	L	L	L	L
WRITE All Bytes	L	X	X	X	X	X

**INTERLEAVED BURST ADDRESS TABLE (MODE = V<sub>CCQ</sub> or No Connect)**

External Address A1 A0	1st Burst Address A1 A0	2nd Burst Address A1 A0	3rd Burst Address A1 A0
00	01	10	11
01	00	11	10
10	11	00	01
11	10	01	00

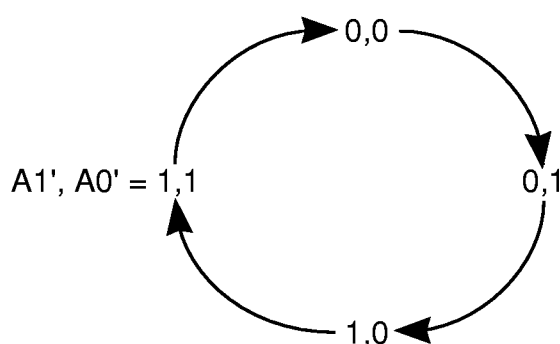
**LINEAR BURST ADDRESS TABLE (MODE = GND<sub>Q</sub>)****ABSOLUTE MAXIMUM RATINGS<sup>(1)</sup>**

Symbol	Parameter	Value	Unit
T <sub>BIAS</sub>	Temperature Under Bias	-10 to +85	°C
T <sub>STG</sub>	Storage Temperature	-55 to +150	°C
P <sub>D</sub>	Power Dissipation	1.8	W
I <sub>OUT</sub>	Output Current (per I/O)	100	mA
V <sub>IN</sub> , V <sub>OUT</sub>	Voltage Relative to GND for I/O Pins	-0.5 to V <sub>CCQ</sub> + 0.3	V
V <sub>IN</sub>	Voltage Relative to GND for for Address and Control Inputs	-0.5 to 5.5	V

**Notes:**

1. Stress greater than those listed under ABSOLUTE MAXIMUM RATINGS may cause permanent damage to the device. This is a stress rating only and functional operation of the device at these or any other conditions above those indicated in the operational sections of this specification is not implied. Exposure to absolute maximum rating conditions for extended periods may affect reliability.
2. This device contains circuitry to protect the inputs against damage due to high static voltages or electric fields; however, precautions may be taken to avoid application of any voltage higher than maximum rated voltages to this high-impedance circuit.
3. This device contains circuitry that will ensure the output devices are in High-Z at power up.

## OPERATING RANGE

Range	Ambient Temperature	V <sub>CC</sub>
Commercial	0°C to +70°C	3.3V +10%, -5%
Industrial	-40°C to +85°C	3.3V +10%, -5%

DC ELECTRICAL CHARACTERISTICS<sup>(1)</sup> (Over Operating Range)

Symbol	Parameter	Test Conditions	Min.	Max.	Unit
V <sub>OH</sub>	Output HIGH Voltage	I <sub>OH</sub> = -5.0 mA	2.4	—	V
V <sub>OL</sub>	Output LOW Voltage	I <sub>OL</sub> = 5.0 mA	—	0.4	V
V <sub>IH</sub>	Input HIGH Voltage		2.0	V <sub>CCQ</sub> + 0.3	V
V <sub>IL</sub>	Input LOW Voltage		-0.3	0.8	V
I <sub>LI</sub>	Input Leakage Current	GND ≤ V <sub>IN</sub> ≤ V <sub>CCQ</sub> <sup>(2)</sup>	Com. Ind.	-5 10	μA
I <sub>LO</sub>	Output Leakage Current	GND ≤ V <sub>OUT</sub> ≤ V <sub>CCQ</sub> , $\overline{OE} = V_{IH}$	Com. Ind.	-5 10	μA

## POWER SUPPLY CHARACTERISTICS (Over Operating Range)

Symbol	Parameter	Test Conditions	-9		-10		Unit	
			Typ.	Max.	Typ.	Max.		
I <sub>CC</sub>	AC Operating Supply Current	Device Selected,	Com.	120	150	110	140	mA
		All Inputs = V <sub>IL</sub> or V <sub>IH</sub> $\overline{OE} = V_{IH}$ , Cycle Time ≥ t <sub>kc</sub> min.	Ind.	—	—	120	150	μA
I <sub>SB</sub>	Standby Current	Device Deselected,	Com.	15	45	15	45	mA
		V <sub>CC</sub> = Max., All Inputs = V <sub>IH</sub> or V <sub>IL</sub> CLK Cycle Time ≥ t <sub>kc</sub> min.	Ind.	20	50	20	50	μA
I <sub>ZZ</sub>	Power-Down Mode Current	ZZ = V <sub>CCQ</sub> , CLK Running	Com.	1	10	1	10	mA
		All Inputs ≤ GND + 0.2V or ≥ V <sub>CC</sub> - 0.2V	Ind.	2	20	2	20	mA

Note:

- MODE pin has an internal pull-up. ZZ pin has an internal pull-down. These pins may be a No Connect, tied to GND, or tied to V<sub>CCQ</sub>.
- MODE pin should be tied to V<sub>CC</sub> or GND. They exhibit ±10 μA maximum leakage current when tied to ≤ GND + 0.2V or ≥ V<sub>CC</sub> - 0.2V.

**CAPACITANCE<sup>(1,2)</sup>**

Symbol	Parameter	Conditions	Max.	Unit
C <sub>IN</sub>	Input Capacitance	V <sub>IN</sub> = 0V	6	pF
C <sub>OUT</sub>	Input/Output Capacitance	V <sub>OUT</sub> = 0V	8	pF

**Notes:**

1. Tested initially and after any design or process changes that may affect these parameters.
2. Test conditions: T<sub>A</sub> = 25°C, f = 1 MHz, V<sub>CC</sub> = 3.3V.

**AC TEST CONDITIONS**

Parameter	Unit
Input Pulse Level	0V to 3.0V
Input Rise and Fall Times	1.5 ns
Input and Output Timing and Reference Level	1.5V
Output Load	See Figure 1

**AC TEST LOADS**

Figure 1

**READ CYCLE SWITCHING CHARACTERISTICS** (Over Operating Range)

Symbol	Parameter	-9		-10		Unit
		Min.	Max.	Min.	Max.	
t <sub>CC</sub>	Cycle Time	13	—	15	—	ns
t <sub>KH</sub>	Clock High Time	6	—	6	—	ns
t <sub>KL</sub>	Clock Low Time	6	—	6	—	ns
t <sub>KQ</sub>	Clock Access Time	—	9	—	10	ns
t <sub>KQX</sub> <sup>(2)</sup>	Clock High to Output Invalid	2	—	2	—	ns
t <sub>KQLZ</sub> <sup>(2)</sup>	Clock High to Output Low-Z	0	—	0	—	ns
t <sub>KQHZ</sub> <sup>(2)</sup>	Clock High to Output High-Z	2	6	2	6	ns
t <sub>AS</sub>	Address Setup Time	2.5	—	2.5	—	ns
t <sub>SS</sub>	Address Status Setup Time	2.5	—	2.5	—	ns
t <sub>WS</sub>	Write Setup Time	2.5	—	2.5	—	ns
t <sub>CES</sub>	Chip Enable Setup Time	2.5	—	2.5	—	ns
t <sub>AVS</sub>	Address Advance Setup Time	2.5	—	2.5	—	ns
t <sub>AH</sub>	Address Hold Time	0.5	—	0.5	—	ns
t <sub>SH</sub>	Address Status Hold Time	0.5	—	0.5	—	ns
t <sub>WH</sub>	Write Hold Time	0.5	—	0.5	—	ns
t <sub>CEH</sub>	Chip Enable Hold Time	0.5	—	0.5	—	ns
t <sub>AVH</sub>	Address Advance Hold Time	0.5	—	0.5	—	ns
t <sub>CFG</sub>	Configuration Setup <sup>(1)</sup>	66.7	—	80	—	ns

**Notes:**

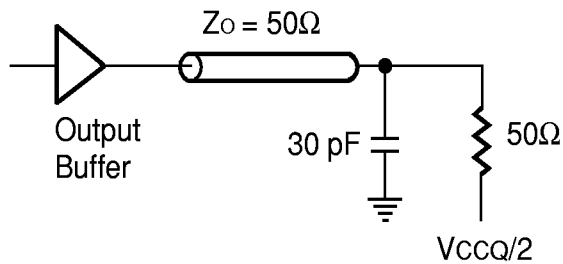
1. Configuration signal MODE is static and must not change during normal operation.
2. Guaranteed but not 100% tested. This parameter is periodically sampled.



READ CYCLE TIMING

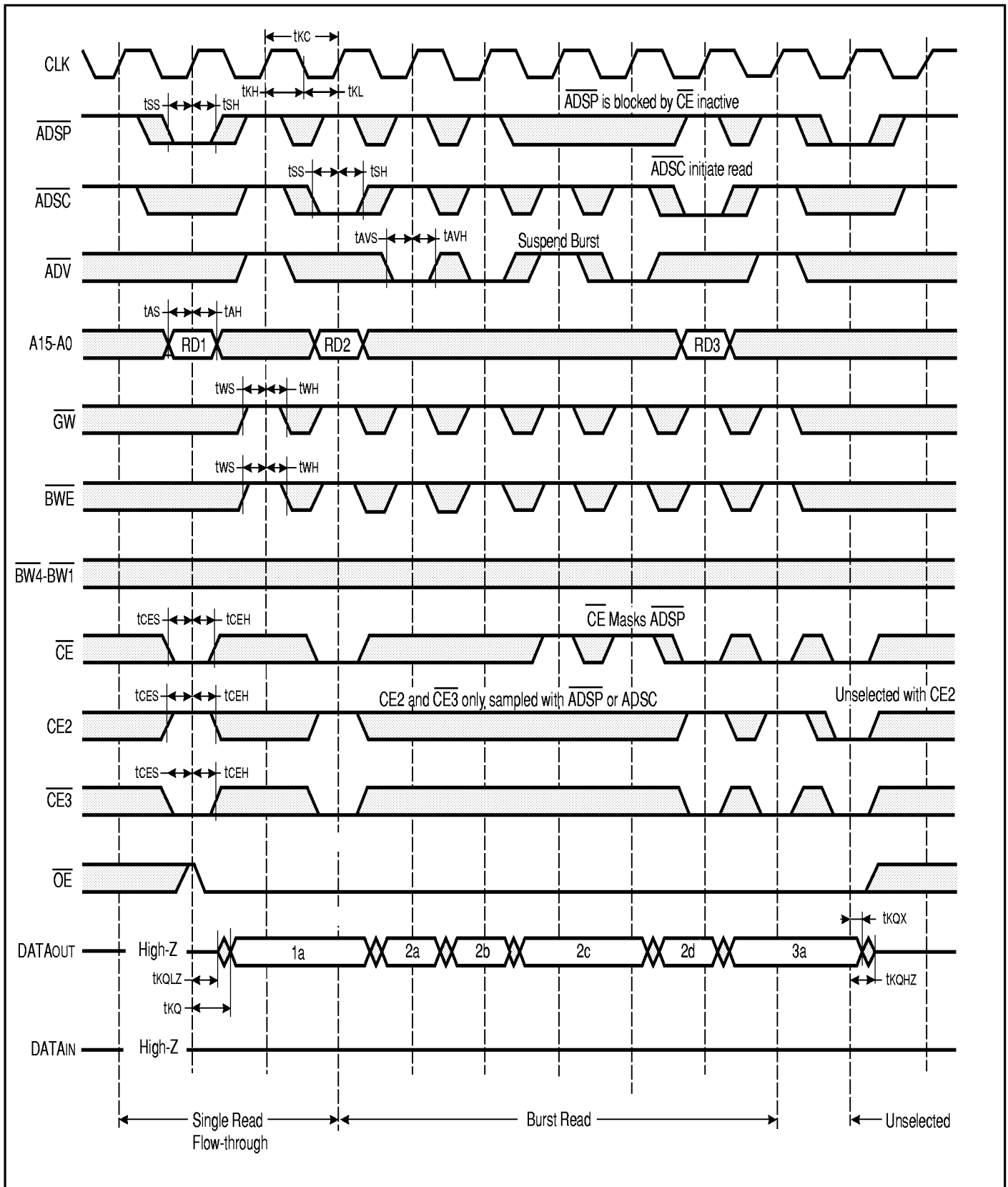

**WRITE CYCLE SWITCHING CHARACTERISTICS** (Over Operating Range)

Symbol	Parameter	-9		-10		Unit
		Min.	Max.	Min.	Max.	
t <sub>CC</sub>	Cycle Time	13	—	15	—	ns
t <sub>KH</sub>	Clock High Time	6	—	6	—	ns
t <sub>KL</sub>	Clock Low Time	6	—	6	—	ns
t <sub>AS</sub>	Address Setup Time	2.5	—	2.5	—	ns
t <sub>SS</sub>	Address Status Setup Time	2.5	—	2.5	—	ns
t <sub>WS</sub>	Write Setup Time	2.5	—	2.5	—	ns
t <sub>DS</sub>	Data In Setup Time	2.5	—	2.5	—	ns
t <sub>CEs</sub>	Chip Enable Setup Time	2.5	—	2.5	—	ns
t <sub>AVS</sub>	Address Advance Setup Time	2.5	—	2.5	—	ns
t <sub>AH</sub>	Address Hold Time	0.5	—	0.5	—	ns
t <sub>SH</sub>	Address Status Hold Time	0.5	—	0.5	—	ns
t <sub>DH</sub>	Data In Hold Time	0.5	—	0.5	—	ns
t <sub>WH</sub>	Write Hold Time	0.5	—	0.5	—	ns
t <sub>CEH</sub>	Chip Enable Hold Time	0.5	—	0.5	—	ns
t <sub>AVH</sub>	Address Advance Hold Time	0.5	—	0.5	—	ns
t <sub>CFG</sub>	Configuration Setup <sup>(1)</sup>	52	—	60	—	ns

**Notes:**

1. Configuration signal MODE is static and must not change during normal operation.

WRITE CYCLE TIMING

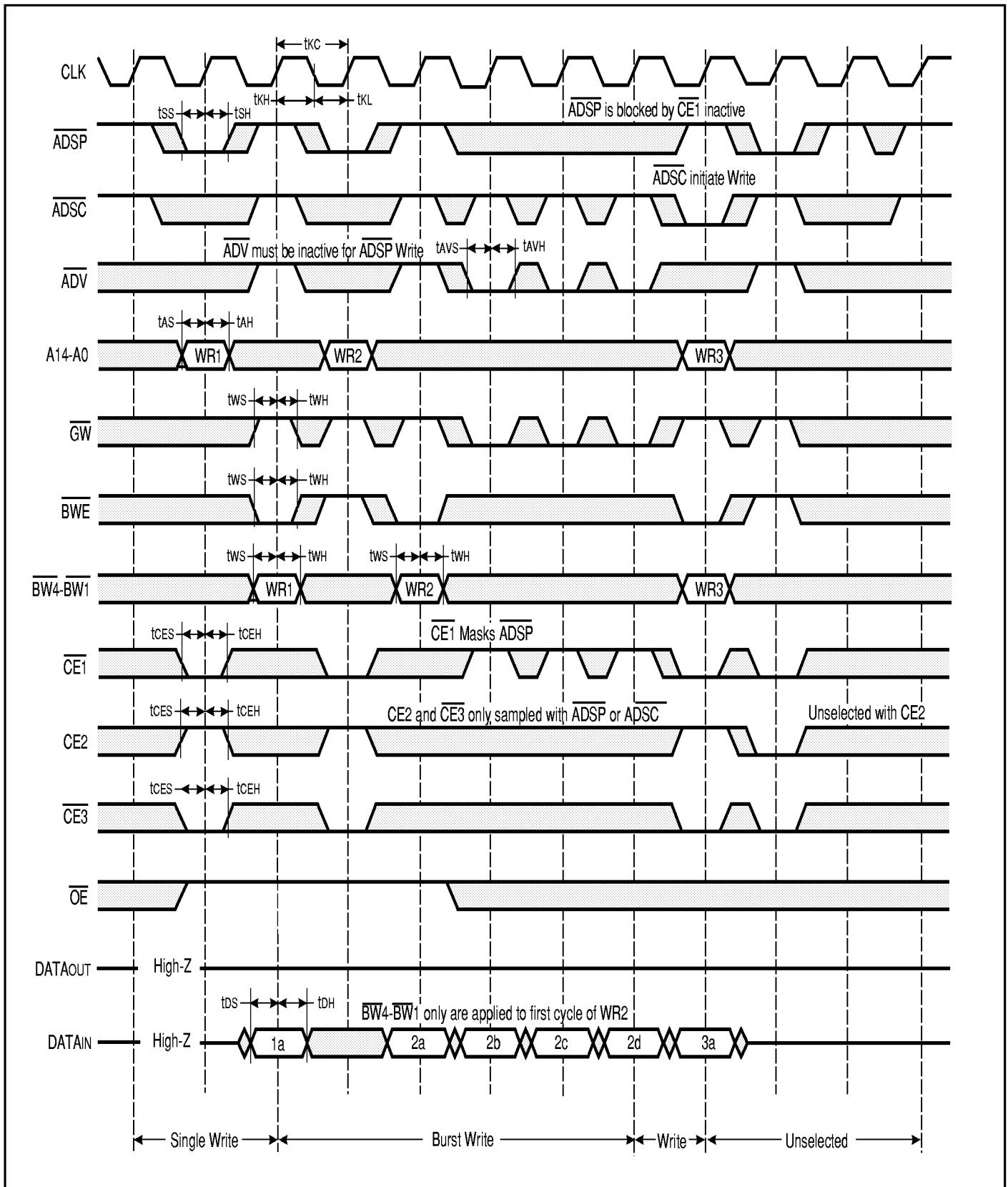

**READ/WRITE CYCLE SWITCHING CHARACTERISTICS** (Over Operating Range)

Symbol	Parameter	-9		-10		Unit
		Min.	Max.	Min.	Max.	
t <sub>CC</sub>	Cycle Time	13	—	15	—	ns
t <sub>KH</sub>	Clock High Time	6	—	6	—	ns
t <sub>KL</sub>	Clock Low Time	6	—	6	—	ns
t <sub>KQ</sub>	Clock Access Time	—	9	—	10	ns
t <sub>KQX</sub> <sup>(2)</sup>	Clock High to Output Invalid	2	—	2	—	ns
t <sub>KQLZ</sub> <sup>(2)</sup>	Clock High to Output Low-Z	0	—	0	—	ns
t <sub>KQHZ</sub> <sup>(2)</sup>	Clock High to Output High-Z	2	6	2	6	ns
t <sub>OEQX</sub> <sup>(2)</sup>	Output Disable to Output Invalid	0	—	0	—	ns
t <sub>OEHZ</sub> <sup>(2)</sup>	Output Disable to Output High-Z	—	6	—	6	ns
t <sub>AS</sub>	Address Setup Time	2.5	—	2.5	—	ns
t <sub>SS</sub>	Address Status Setup Time	2.5	—	2.5	—	ns
t <sub>WS</sub>	Write Setup Time	2.5	—	2.5	—	ns
t <sub>CES</sub>	Chip Enable Setup Time	2.5	—	2.5	—	ns
t <sub>AH</sub>	Address Hold Time	0.5	—	0.5	—	ns
t <sub>SH</sub>	Address Status Hold Time	0.5	—	0.5	—	ns
t <sub>WH</sub>	Write Hold Time	0.5	—	0.5	—	ns
t <sub>CEH</sub>	Chip Enable Hold Time	0.5	—	0.5	—	ns
t <sub>CFG</sub>	Configuration Setup <sup>(1)</sup>	52	—	60	—	ns

**Notes:**

1. Configuration signal MODE is static and must not change during normal operation.
2. Guaranteed but not 100% tested. This parameter is periodically sampled.

READ/WRITE CYCLE TIMING

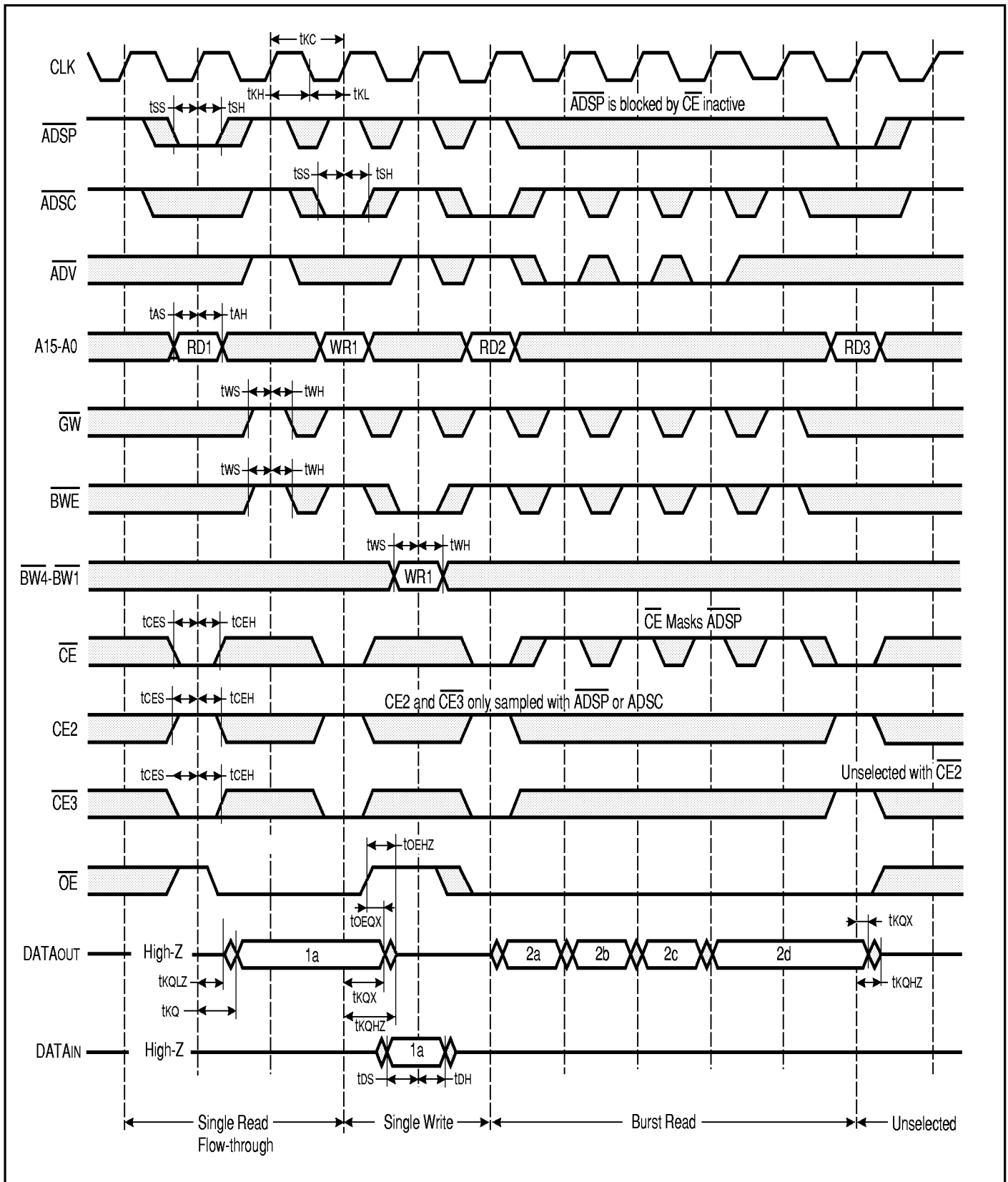

**SNOOZE AND RECOVERY CYCLE SWITCHING CHARACTERISTICS** (Over Operating Range)

Symbol	Parameter	-9		-10		Unit
		Min.	Max.	Min.	Max.	
t <sub>KC</sub>	Cycle Time	13	—	15	—	ns
t <sub>KH</sub>	Clock High Time	6	—	6	—	ns
t <sub>KL</sub>	Clock Low Time	6	—	6	—	ns
t <sub>KQ</sub>	Clock Access Time	—	7	—	8	ns
t <sub>KQX</sub> <sup>(4)</sup>	Clock High to Output Invalid	2	—	2	—	ns
t <sub>KQLZ</sub> <sup>(4)</sup>	Clock High to Output Low-Z	0	—	0	—	ns
t <sub>KQHZ</sub> <sup>(2)</sup>	Clock High to Output High-Z	2	6	2	6	ns
t <sub>OEQ</sub>	Output Enable to Output Valid	—	6	—	6	ns
t <sub>OEQX</sub> <sup>(2)</sup>	Output Disable to Output Invalid	0	—	0	—	ns
t <sub>OELZ</sub> <sup>(2)</sup>	Output Enable to Output Low-Z	0	—	0	—	ns
t <sub>OEHZ</sub> <sup>(2)</sup>	Output Disable to Output High-Z	—	6	—	6	ns
t <sub>AS</sub>	Address Setup Time	2.5	—	2.5	—	ns
t <sub>SS</sub>	Address Status Setup Time	2.5	—	2.5	—	ns
t <sub>CES</sub>	Chip Enable Setup Time	2.5	—	2.5	—	ns
t <sub>AH</sub>	Address Hold Time	0.5	—	0.5	—	ns
t <sub>SH</sub>	Address Status Hold Time	0.5	—	0.5	—	ns
t <sub>CEH</sub>	Chip Enable Hold Time	0.5	—	0.5	—	ns
t <sub>ZZS</sub>	ZZ Standby <sup>(1)</sup>	—	8	—	8	ns
t <sub>ZZREC</sub>	ZZ Recovery <sup>(2)</sup>	8	—	8	—	ns

**Notes:**

1. The assertion of ZZ allows the SRAM to enter a lower power state than when deselected within the time specified. Data retention is guaranteed when ZZ is asserted and clock remains active.
2.  $\overline{ADSC}$  and  $\overline{ADSP}$  must not be asserted for at least 8 ns after leaving ZZ state.
3. Configuration signal MODE is static and must not change during normal operation.
4. Guaranteed but not 100% tested. This parameter is periodically sampled.

**SNOOZE AND RECOVERY CYCLE TIMING**

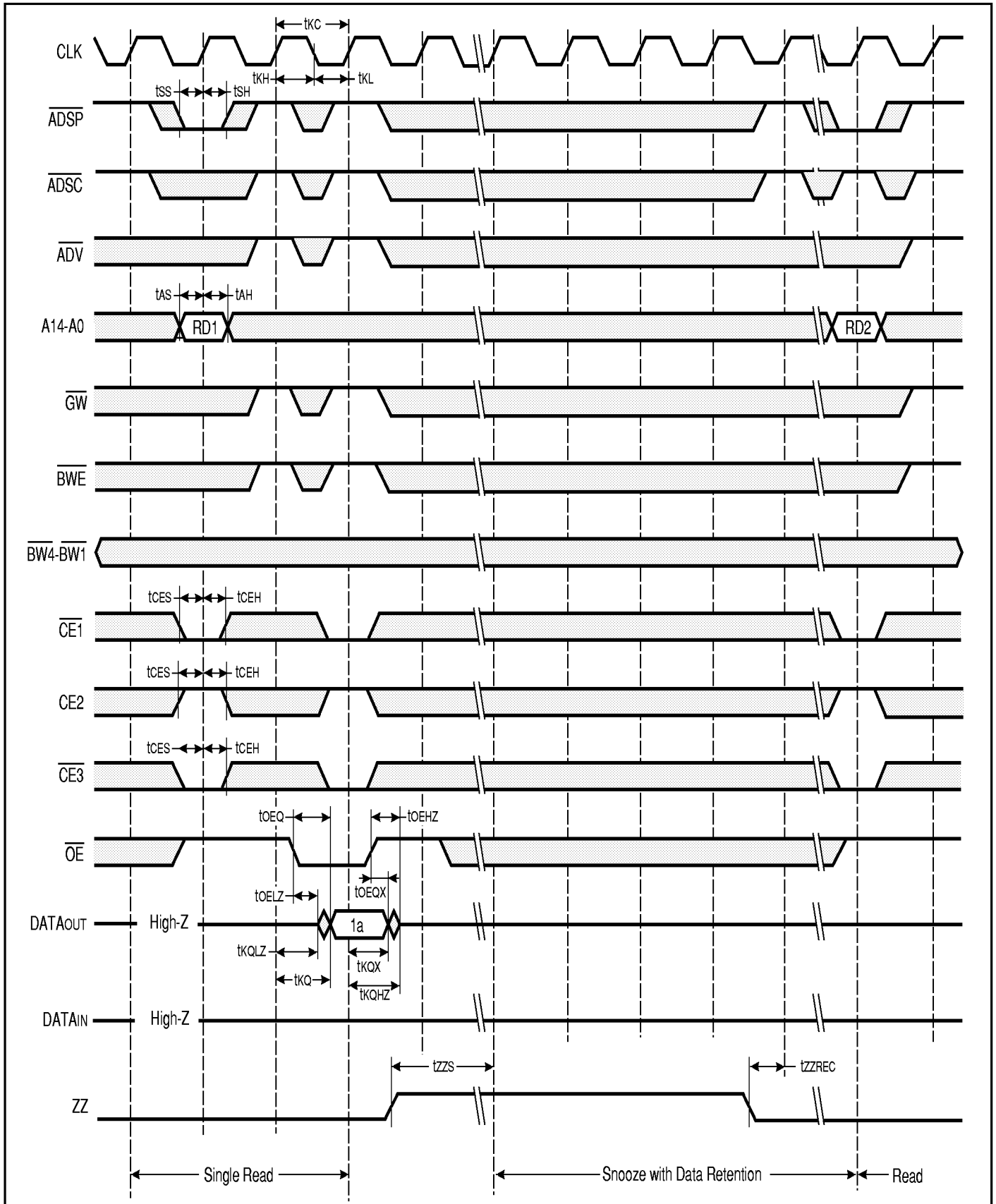

**ORDERING INFORMATION****Commercial Range: 0°C to +70°C**

Speed (ns)	Order Part Number	Package
9	IS61SF632A-9TQ	TQFP
9	IS61SF632A-9PQ	PQFP
10	IS61SF632A-10TQ	TQFP
10	IS61SF632A-10PQ	PQFP

**Industrial Range: -40°C to +85°C**

Speed (ns)	Order Part Number	Package
10	IS61SF632A-10TQI	TQFP
10	IS61SF632A-10PQI	PQFP