

AOT500L
N-Channel Enhancement Mode Field Effect Transistor
General Description

AOT500 uses an optimally designed temperature compensated gate-drain zener clamp. Under overvoltage conditions, the clamp activates and turns on the MOSFET, safely dissipating the energy in the MOSFET.

The built in resistor guarantees proper clamp operation under all circuit conditions, and the MOSFET never goes into avalanche breakdown. Advanced trench technology provides excellent low $R_{DS(on)}$, gate charge and body diode characteristics, making this device ideal for motor and inductive load control applications.

Standard Product AOT500 is Pb-free (meets ROHS & Sony 259 specifications)

Features

V_{DS} (V) = Clamped

$I_D = 80A$ ($V_{GS} = 10V$)

$R_{DS(ON)} < 5.3 m\Omega$ ($V_{GS} = 10V$)

100% UIS tested

100% Rg tested

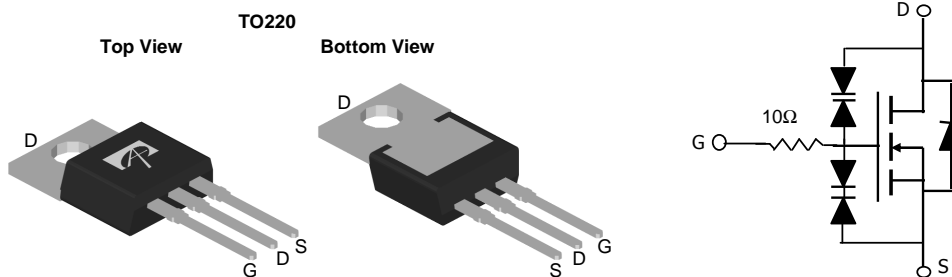
Absolute Maximum Ratings $T_A=25^\circ C$ unless otherwise noted

Parameter	Symbol	Maximum	Units
Drain-Source Voltage	V_{DS}	clamped	V
Gate-Source Voltage	V_{GS}	clamped	V
Continuous Drain Current ^G	I_D	$T_C=25^\circ C$	80
		$T_C=100^\circ C$	57
Continuous Drain Gate Current	I_{DG}	± 50	mA
Continuous Gate Source Current	I_{GS}	± 50	
Pulsed Drain Current ^C	I_{DM}	250	A
Avalanche Current $L=100\mu H^H$	I_{AR}	50	A
Repetitive avalanche energy ^H	E_{AR}	125	mJ
Power Dissipation ^B	P_D	$T_C=25^\circ C$	115
		$T_C=100^\circ C$	58
Junction and Storage Temperature Range	T_J, T_{STG}	-55 to 175	$^\circ C$

Thermal Characteristics

Parameter	Symbol	Typ	Max	Units
Maximum Junction-to-Ambient ^A	$R_{\theta JA}$	60	75	$^\circ C/W$
Maximum Junction-to-Case ^B	$R_{\theta JC}$	0.7	1.3	$^\circ C/W$

Electrical Characteristics ($T_J=25^\circ\text{C}$ unless otherwise noted)

Symbol	Parameter	Conditions	Min	Typ	Max	Units
STATIC PARAMETERS						
$BV_{DSS(z)}$	Drain-Source Breakdown Voltage	$I_D=10\text{mA}$, $V_{GS}=0\text{V}$	33			V
BV_{CLAMP}	Drain-Source Clamping Voltage	$I_D=1\text{A}$, $V_{GS}=0\text{V}$	36		44	V
$I_{DSS(z)}$	Zero Gate Voltage Drain Current	$V_{DS}=16\text{V}$, $V_{GS}=0\text{V}$			30	μA
BV_{GSS}	Gate-Source Voltage	$V_{DS}=0\text{V}$, $I_D=250\mu\text{A}$	20			V
I_{GSS}	Gate-Body leakage current	$V_{DS}=0\text{V}$, $V_{GS}=\pm 10\text{V}$			10	μA
$V_{GS(th)}$	Gate Threshold Voltage	$V_{DS}=V_{GS}$, $I_D=250\mu\text{A}$	1.5	2	3	V
$I_{D(ON)}$	On state drain current	$V_{GS}=10\text{V}$, $V_{DS}=5\text{V}$	250			A
$R_{DS(ON)}$	Static Drain-Source On-Resistance	$V_{GS}=10\text{V}$, $I_D=30\text{A}$		4.1	5.3	$\text{m}\Omega$
		$T_J=125^\circ\text{C}$		6.2		
g_{FS}	Forward Transconductance	$V_{DS}=5\text{V}$, $I_D=30\text{A}$		95		S
V_{SD}	Diode Forward Voltage	$I_S=1\text{A}$, $V_{GS}=0\text{V}$		0.7	1	V
I_S	Maximum Body-Diode Continuous Current				80	A
DYNAMIC PARAMETERS						
C_{iss}	Input Capacitance	$V_{GS}=0\text{V}$, $V_{DS}=15\text{V}$, $f=1\text{MHz}$		4200	5500	pF
C_{oss}	Output Capacitance			765		pF
C_{rss}	Reverse Transfer Capacitance			340		pF
R_g	Gate resistance	$V_{GS}=0\text{V}$, $V_{DS}=0\text{V}$, $f=1\text{MHz}$		13	30	Ω
SWITCHING PARAMETERS						
$Q_g(10\text{V})$	Total Gate Charge	$V_{GS}=10\text{V}$, $V_{DS}=15\text{V}$, $I_D=30\text{A}$		69	89	nC
$Q_g(4.5\text{V})$	Total Gate Charge			34		nC
Q_{gs}	Gate Source Charge			12		nC
Q_{gd}	Gate Drain Charge			15		nC
$t_{D(on)}$	Turn-On DelayTime	$V_{GS}=10\text{V}$, $V_{DS}=15\text{V}$, $R_L=0.5\Omega$, $R_{GEN}=3\Omega$		25		ns
t_r	Turn-On Rise Time			35		ns
$t_{D(off)}$	Turn-Off DelayTime			150		ns
t_f	Turn-Off Fall Time			62		ns
t_{rr}	Body Diode Reverse Recovery Time	$I_F=30\text{A}$, $dI/dt=100\text{A}/\mu\text{s}$		60	78	ns
Q_{rr}	Body Diode Reverse Recovery Charge	$I_F=30\text{A}$, $dI/dt=100\text{A}/\mu\text{s}$		84		nC

A: The value of $R_{\theta JA}$ is measured with the device in a still air environment with $T_A=25^\circ\text{C}$.

B: The power dissipation P_D is based on $T_{J(MAX)}=175^\circ\text{C}$, using junction-to-case thermal resistance, and is more useful in setting the upper dissipation limit for cases where additional heatsinking is used.

C: Repetitive rating, pulse width limited by junction temperature $T_{J(MAX)}=175^\circ\text{C}$.

D: The $R_{\theta JA}$ is the sum of the thermal impedance from junction to case $R_{\theta JC}$ and case to ambient.

E: The static characteristics in Figures 1 to 6 are obtained using $<300\mu\text{s}$ pulses, duty cycle 0.5% max.

F: These curves are based on the junction-to-case thermal impedance which is measured with the device mounted to a large heatsink, assuming a maximum junction temperature of $T_{J(MAX)}=175^\circ\text{C}$.

G: The maximum current rating is limited by bond-wires.

H: E_{AR} and I_{AR} are based on a 100uH inductor with $T_J(\text{start}) = 25^\circ\text{C}$ for each pulse.

Rev 2: Dec 2010

THIS PRODUCT HAS BEEN DESIGNED AND QUALIFIED FOR THE CONSUMER MARKET. APPLICATIONS OR USES AS CRITICAL COMPONENTS IN LIFE SUPPORT DEVICES OR SYSTEMS ARE NOT AUTHORIZED. AOS DOES NOT ASSUME ANY LIABILITY ARISING OUT OF SUCH APPLICATIONS OR USES OF ITS PRODUCTS. AOS RESERVES THE RIGHT TO IMPROVE PRODUCT DESIGN, FUNCTIONS AND RELIABILITY WITHOUT NOTICE.

TYPICAL ELECTRICAL AND THERMAL CHARACTERISTICS

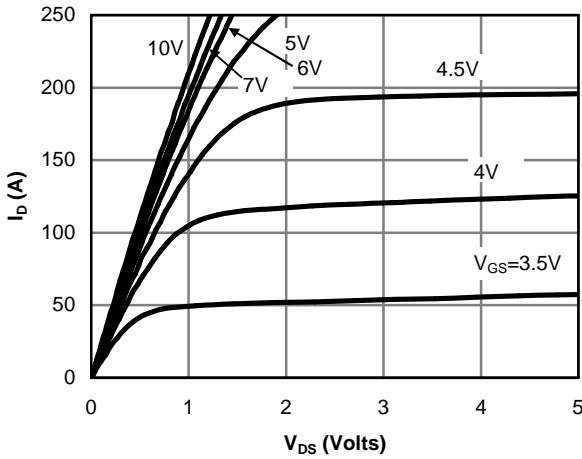

Fig 1: On-Region Characteristics

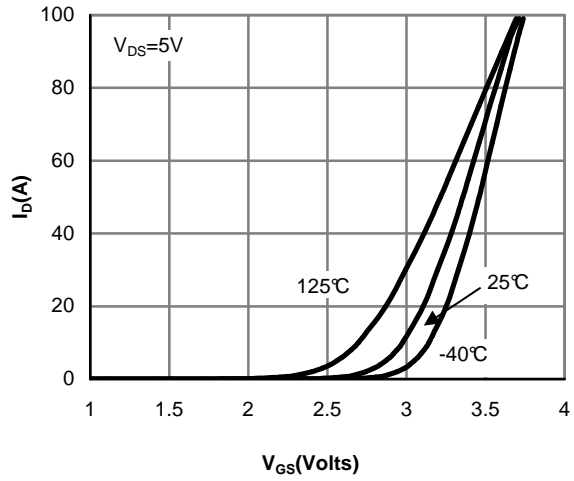

Figure 2: Transfer Characteristics

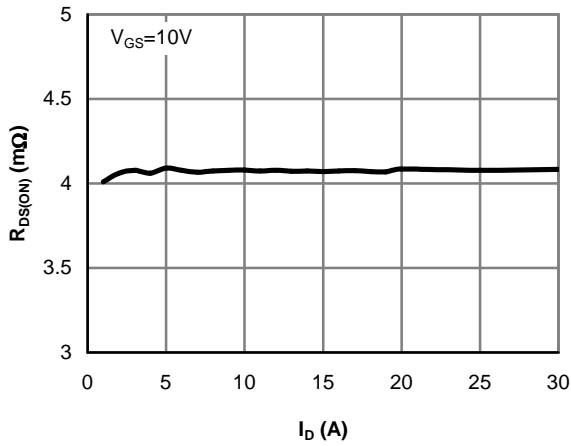

Figure 3: On-Resistance vs. Drain Current and Gate Voltage

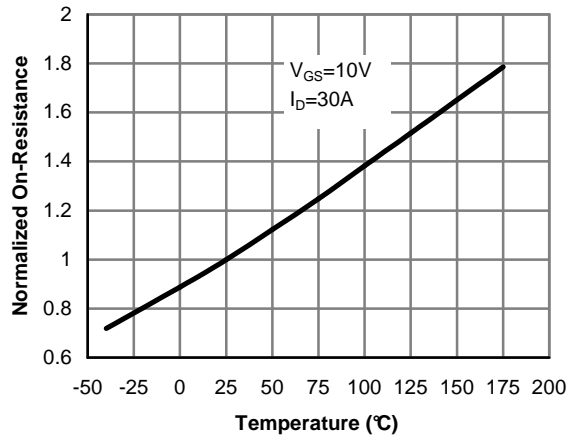

Figure 4: On-Resistance vs. Junction Temperature

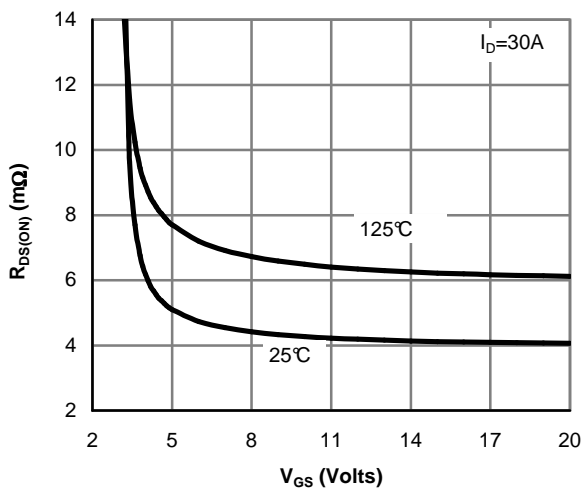

Figure 5: On-Resistance vs. Gate-Source Voltage

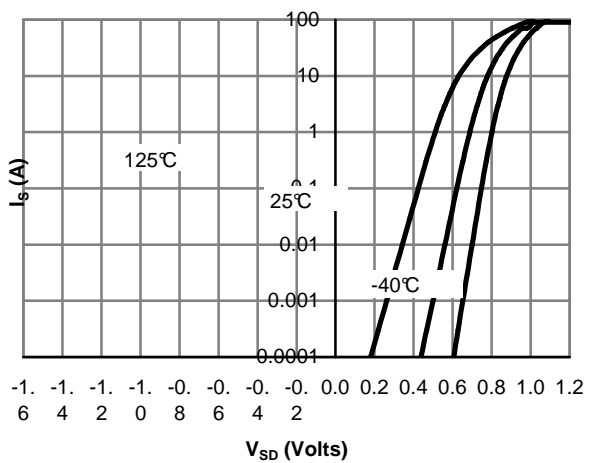

Figure 6: Body-Diode Characteristics

TYPICAL ELECTRICAL AND THERMAL CHARACTERISTICS

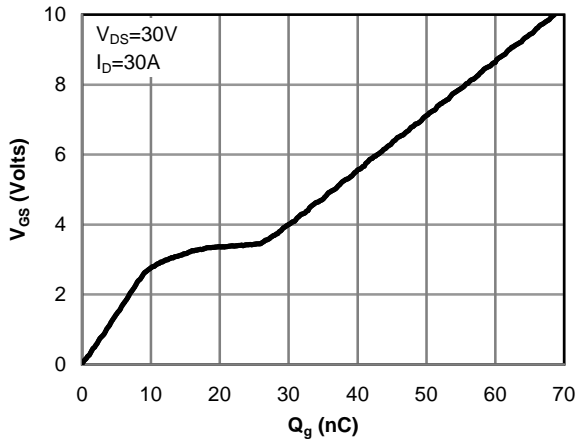

Figure 7: Gate-Charge Characteristics

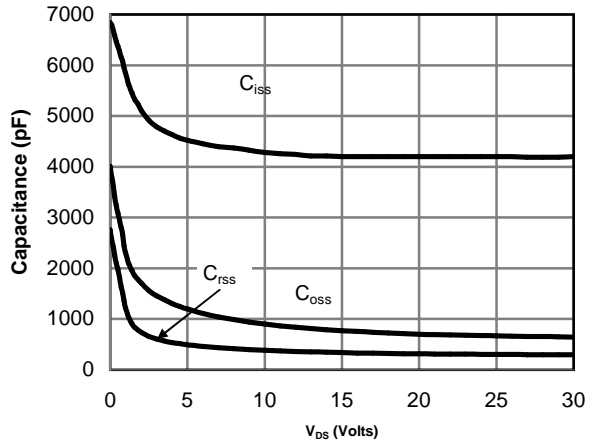

Figure 8: Capacitance Characteristics

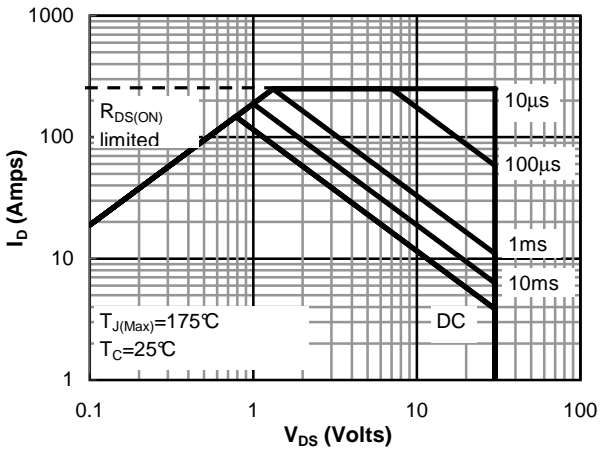

Figure 9: Maximum Forward Biased Safe Operating Area (Note E)

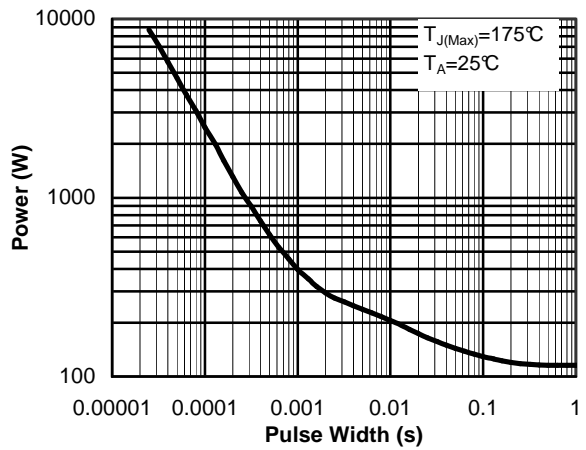

Figure 10: Single Pulse Power Rating Junction-to-Case (Note F)

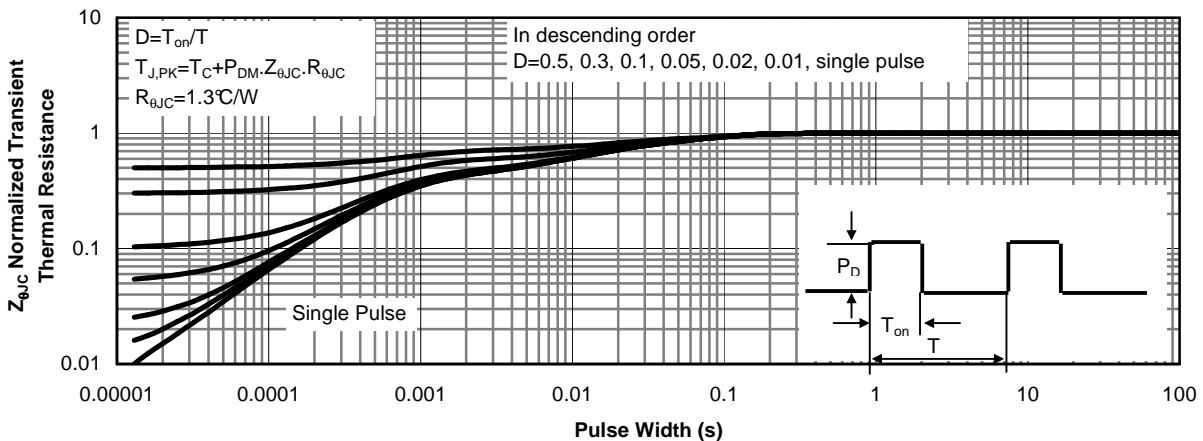

Figure 11: Normalized Maximum Transient Thermal Impedance (Note F)

TYPICAL ELECTRICAL AND THERMAL CHARACTERISTICS

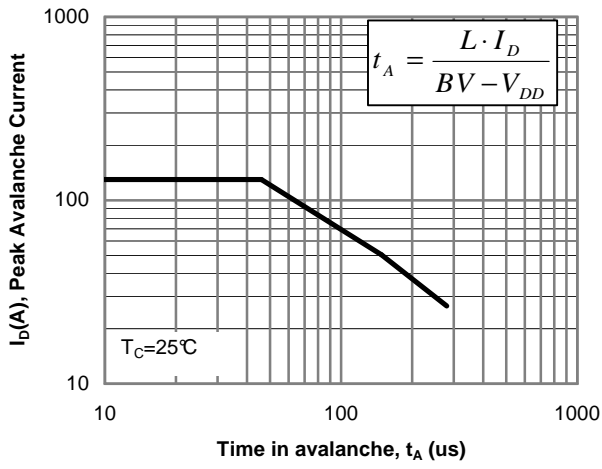

Figure 12: Single Pulse Avalanche capability

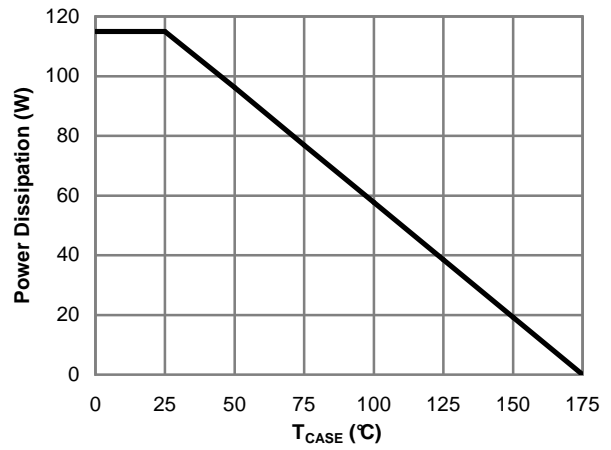

Figure 13: Power De-rating (Note B)

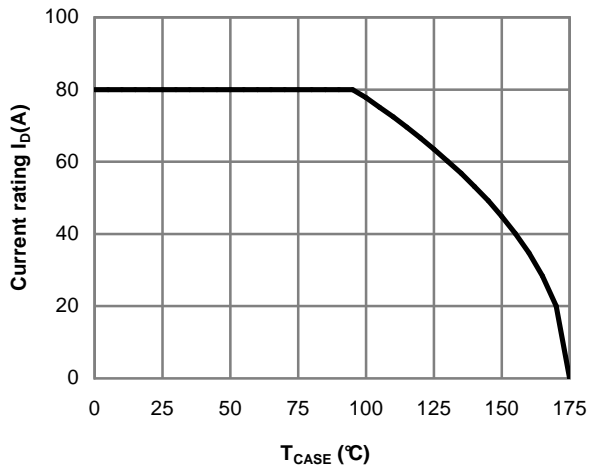

Figure 14: Current De-rating (Note B)

TYPICAL PROTECTION CHARACTERISTICS

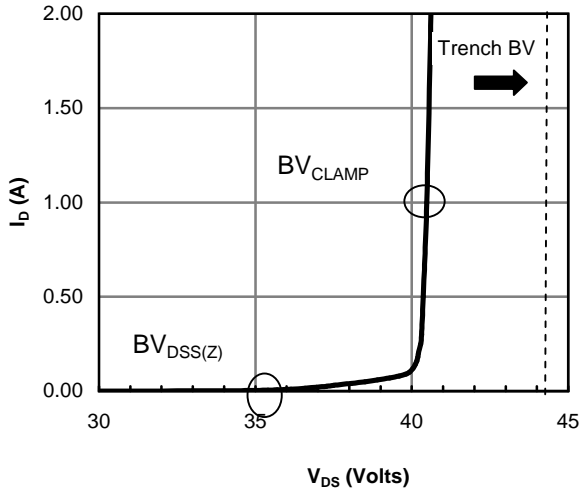

Fig 15: BV_CLAMP Characteristic

This device uses built-in Gate to Source and Gate to Drain zener protection. While the Gate-Source zener protects against excessive V_{GS} conditions, the Gate to Drain protection, clamps the V_{DS} well below the device breakdown, preventing an avalanche condition within the MOSFET as a result of voltage over-shoot at the Drain electrode.

It is designed to breakdown well before the device breakdown. During such an event, current flows through the zener clamp, which is situated internally between the Gate to Drain. This current flows at BV_{DSS(Z)}, building up the V_{GS} internal to the device. When the current level through the zener reaches approximately 300mA, the V_{GS} is approximately equal to V_{GS(PLATEAU)}, allowing significant channel conduction and thus clamping the Drain to Source voltage. The V_{GS} needed to turn the device on is controlled with an internally lumped gate resistor R approximately equal to 10Ω.

$$V_{GS(PLATEAU)} = 10\Omega \times 300mA = 3V$$

It can also be said that the V_{DS} during clamping is equal to:

$$BV_{DSS} = BV_{CLAMP} + V_{GS(PLATEAU)}$$

Additional power loss associated with the protection circuitry can be considered negligible when compare to the conduction losses of the MOSFET itself;

EX:

$$PL = 30\mu A_{max} \times 16V = 0.48mW \quad (\text{Zener leakage loss})$$

$$PL(rds) = 102A \times 6m\Omega = 300mW \quad (\text{MOSFET loss})$$

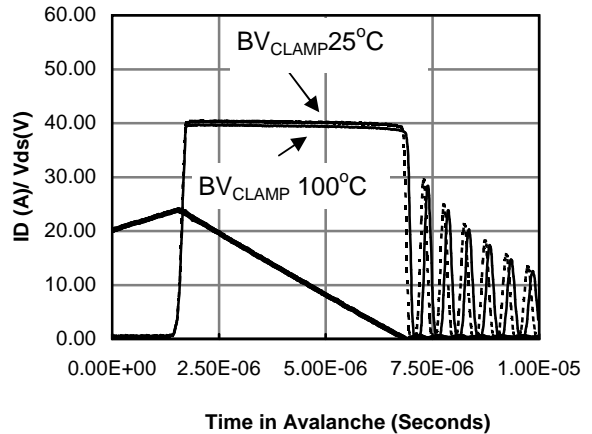
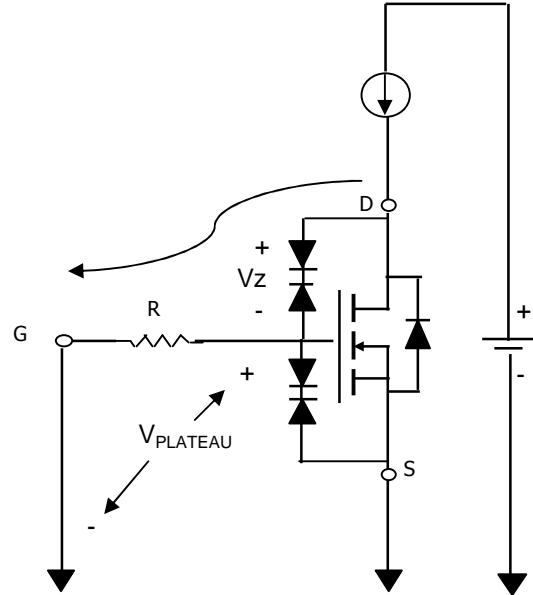
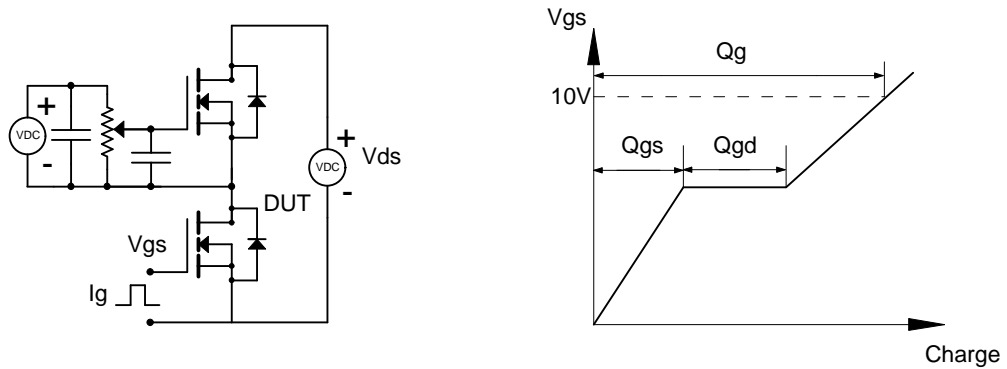

Fig 16: Unclamped Inductive Switching

Fig16: The built-in Gate to Drain clamp prevents the device from going into Avalanche by setting the clamp voltage well below the actual breakdown of the device. When the Drain to Gate voltage approaches the BV clamp, the internal Gate to Source voltage is charged up and channel conduction occurs, sinking the current safely through the device. The BV_{CLAMP} is virtually temperature independent, providing even greater protection during normal operation.

Gate Charge Test Circuit & Waveform



Resistive Switching Test Circuit & Waveforms

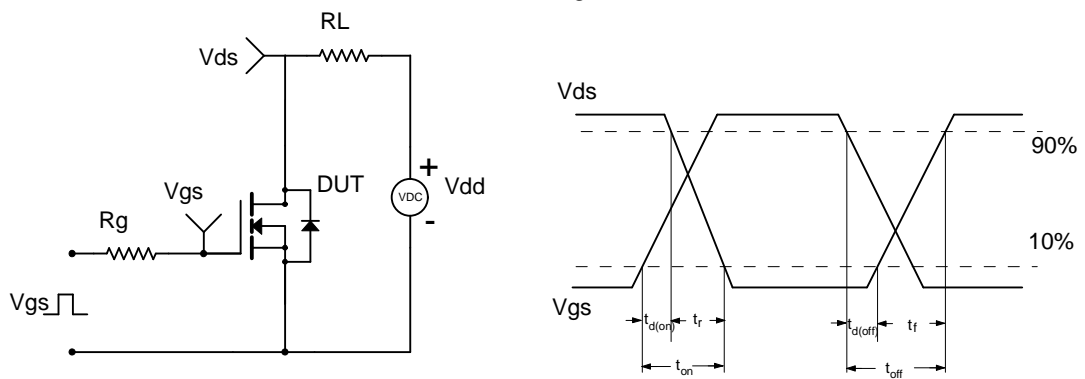

Unclamped Inductive Switching (UIS) Test Circuit & Waveforms

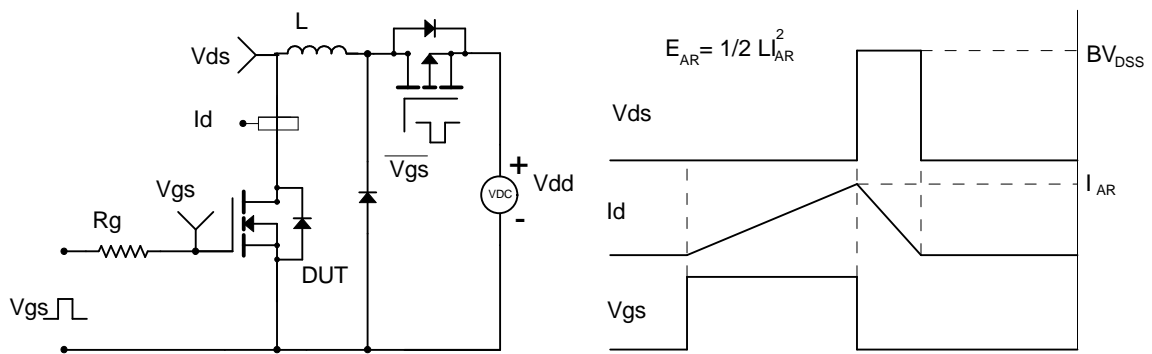

Diode Recovery Test Circuit & Waveforms

