

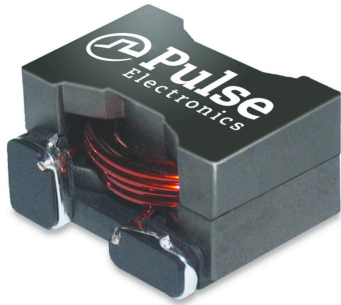





# SMT POWER INDUCTORS

Wire Wound



-  **Height:** 12.2mm Max
-  **Footprint:** 22.2 x 19.1mm Max
-  **Current Rating:** Over 22A<sub>pk</sub>
-  **Inductance Range:** 5.8μH to 57μH
-  **Weight:** ±4%

## Electrical Specifications @ 25°C — Operating Temperature -55°C to +130°C

Part Number	Inductance @0A <sub>DC</sub> (μH ±10%)	Inductance @I <sub>rated</sub> (μH TYP)	I <sub>rated</sub> <sup>1</sup> (A <sub>DC</sub> )	DCR (mΩ ±10%)	Saturation <sup>2</sup> Current I <sub>sat</sub> (A TYP)		Heating <sup>3</sup> Current I <sub>bc</sub> (A TYP)	Core Loss Factor K <sub>2</sub>
					25°C	100°C		
PA2050.582NL	5.8	5.8	14.4	4.4	22	17	14.4	155
PA2050.782NL	7.8	7.8	13.3	5.1	18	16	13.3	181
PA2050.103NL	10.2	10.2	12.5	5.8	16	15	12.5	206
PA2050.163NL	16.0	16.0	9.9	9.1	12	11	9.9	258
PA2050.193NL	19.4	19.4	8.5	12.6	11	10	8.5	284
PA2050.233NL	23.0	23.0	8.0	13.7	9.8	8	8.1	310
PA2050.273NL	27.0	26.2	7.8	14.9	9	8	7.8	335
PA2050.313NL	31.4	30.6	6.7	20.2	8.4	8	6.7	361
PA2050.363NL	36.0	35.2	6.0	21.6	8	6	6.5	387
PA2050.393NL	38.9	37.5	6.0	18.8	6.3	6	6.2	482
PA2050.413NL	41.0	40.0	6.0	23.1	7.3	6	6.2	413
PA2050.583NL	57.8	57.8	5.0	34.5	6.2	5	5.1	490

### Notes:

- The rated current as listed is either the saturation current or the heating current depending on which value is lower.
- The saturation current is the typical current which causes the inductance to drop by 20% at the stated ambient temperatures (25°C and 100°C). This current is determined by placing the component in the specified ambient environment and applying a short duration pulse current (to eliminate self-heating effects) to the component.
- The heating current is the DC current which causes the part temperature to increase by approximately 40°C.
- In high volt\*time applications, additional heating in the component can occur due to core losses in the inductor which may necessitate derating the current in order to limit the temperature rise of the component. To determine the approximate total losses (or temperature rise) for a given application, the coreloss and temperature rise formula can be used:  

$$\Delta B \text{ (Gauss)} = K_2 * \Delta I$$

$$\text{Core Loss (W)} = 1.5E-13 * (\text{Freq\_kHz})^{1.63} * \Delta B^{2.62}$$
- The temperature of the component (ambient plus temperature rise) must be within the stated operating temperature range.
- Add "T" suffix to the part number for Tape & Reel version (i.e. PA2050.582NLT).

## Mechanicals

## Schematics

PE-65612NL

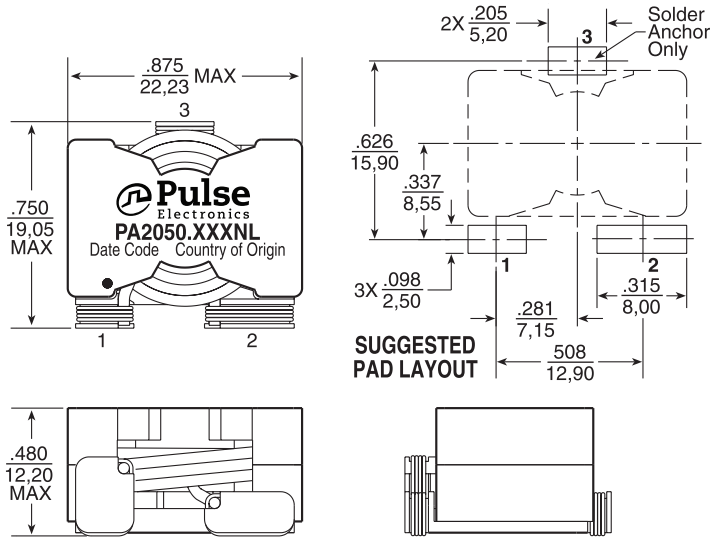

Dimensions:  $\frac{\text{Inches}}{\text{mm}}$   
 Unless otherwise specified, all tolerances are  $\pm \frac{.010}{0,25}$

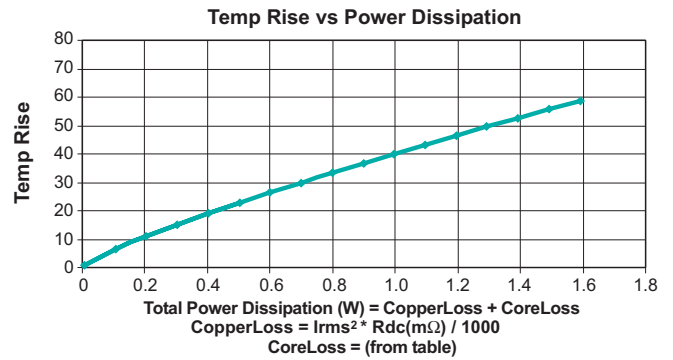
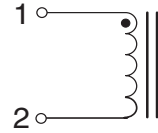

## Inductance vs Current Characteristics

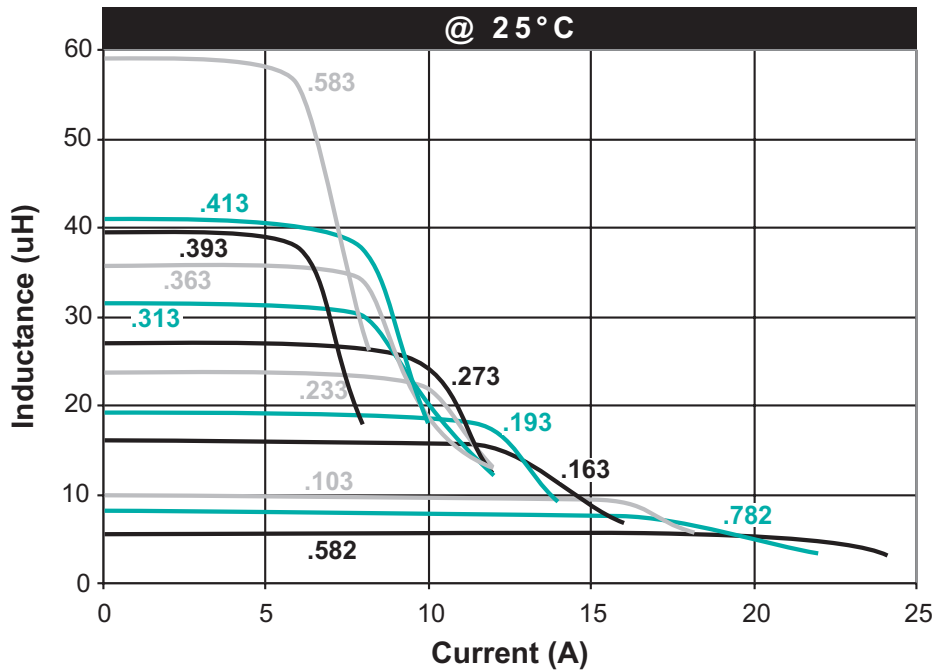

# SMT POWER INDUCTORS

Wire Wound

## Inductance vs Current Characteristics (continued)

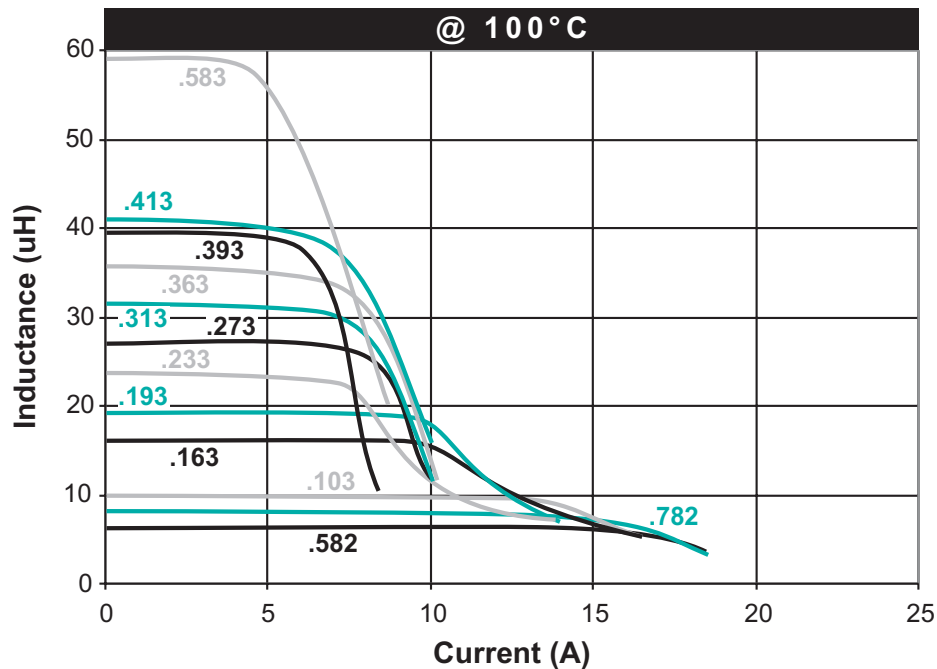

## For More Information

### Pulse North America Headquarters

Two Pearl Buck Court  
Bristol, PA 19007  
U.S.A.

Tel: 215 781 6400  
Fax: 215 781 6403

### Pulse Europe

Einsteinstrasse 1  
D-71083 Herrenberg  
Germany

Tel: 49 7032 7806

### Pulse China Headquarters

B402, Shenzhen Academy of  
Aerospace Technology Bldg.  
10th Kejinan Road  
High-Tech Zone  
Nanshan District  
Shenzhen, PR China  
518057

### Pulse North China

Room 2704/2705  
Super Ocean Finance  
Ctr.  
2067 Yan An Road  
West  
Shanghai 200336  
China

### Pulse South Asia

135 Joo Seng Road  
#03-02  
PM Industrial Bldg.  
Singapore 368363

Tel: 65 6287 8998  
Fax: 65 6287 8998

### Pulse North Asia

3F, No. 198  
Zhongyuan Road  
Zhongli City  
Taoyuan County 320  
Taiwan R. O. C.  
Tel: 886 3 4356768  
Fax: 886 3 4356823  
(Pulse)

Performance warranty of products offered on this data sheet is limited to the parameters specified. Data is subject to change without notice. Other brand and product names mentioned herein may be trademarks or registered trademarks of their respective owners. © Copyright, 2013. Pulse Electronics, Inc. All rights reserved.