



3D View
(This side faces the sky)



Underside View
(Magnet)

MA301.A.AB.001

Specification

Part No.	MA301.A.AB.001
Product Name	MA.301 GPS/Penta-band Cellular Magnetic Antenna
Feature	<p>IP67 - Waterproof</p> <p>GPS - High gain LNA up to 32dB</p> <p>Penta-band 850/900/1800/1900/2100 MHz</p> <p>GSM/GPRS/CDMA/PCS/DCS/UMTS/HSPA</p> <p>Low Profile</p> <p>Height 10.8mm Diameter 55.1mm</p> <p>RoHS Compliant</p>

1. Introduction

The MA.301 is a combination small form factor high performance GPS and Penta-band Cellular (GSM/GPRS/CDMA/PCS/DCS/ WCDMA/UMTS) antenna to simplify AVL or Fleet management antenna systems worldwide.

It comes with magnet mount as standard. An internal O-ring meets stringent IP-67 waterproof standards. With the strongest GPS and Cellular antenna design team in the industry and rigorous testing Taoglas offers guaranteed performance with your system and your environment.

The standard version comes with 3 metres RG174 cable and SMA(M) connectors for both GPS and Cellular feeds. Cables and connectors are customizable upon request.

2. Features

GPS

High LNA Gain up to 32 dB

Antenna Gain 28 ± 2 dB

Miniaturized to 56.3 x 17.3 mm

Low Noise 1.5 dB max

Ultra-Low Power Consumption 6mA typ (at 2.7V~3.3V dc)

Cellular

Advanced penta-band cellular antenna

(GSM/GPRS/CDMA/PCS/DCS/WCDMA/UMTS/HSPA)

CDMA: 824~896 MHz, GSM: 880~960 MHz,

PCS: 850~1990, MHzDCS: 1710~1880

UMTS/WCDMA/HSPA: 2110~2170

Other

IP67 Water Resistant due to Internal O-Ring Structure

Quality textured covert design. Low profile

UV resistant ABS housing

Optional - high grade 3M double sided tape for quick and easy mounting

Optional cables and connectors

ROHS Compliant

3. Performance Specification

Parameter	GPS Antenna	Cellular Antenna
Features	High performance GPS ceramic patch antenna with cutting edge low noise amplifier	CDMA: 824~896 MHz GSM: 880~960 MHz PCS: 850~1990 MHz DCS: 1710~1880 MHz UMTS/WCDMA/HSPA: 2110~2170 MHz
Frequency	1575.42 MHz ± 2MHz	As above
Gain	28 dB typ. Gain at Zenith: -3 dBi min Axial Ratio: 3.0 dB max	As patterns --- ---
Noise Figure	1.5 dB max	---
Polarization	RHCP	Linear
Bandwidth	10 MHz min @ -10 dB	As S11
VSWR	1.92 max	<=2.5
Impedance	50Ω	50Ω
Power Consumption	6mA (at 2.7 ~ 3.3V dc)	---
Cable / Connector	Standard 2/3/5m RG-174 Cables and Connectors Fully Customisable	Standard 2/3/5m RG-174 Cables and Connectors Fully Customisable
Operating Temperature	-40°C ~ +85°C	-40°C ~ +85°C
Storage Temperature	-40°C ~ +90°C	-40°C ~ +90°C
Size	56.3mm * 17.3mm	
O-Ring	Embedded	
Housing	UV resistant ABS	

*Note: specifications may be subject to change

Note

- The antenna is measured mounted on a 39 (L) × 34.5 (W) cm metal ground
- All data are measured with RG-174 cable (length = 3M), excluding the LNA data
- RG-174 cable attenuation (dB/100mm)

GHz	0.5	1	1.5	2	2.5	3	3.5	4	4.5	5	5.5	6
RG-174	67	110	127	153	168	183	207	229	252	272	291	311

4. GPS Ceramic Antenna

S22 REVERSE REFLECTION CHN2 TRANSMISSION / REFLECTION
 LOG MAGNITUDE ▶ REF = 0.000 dB 10.000 dB/DIV

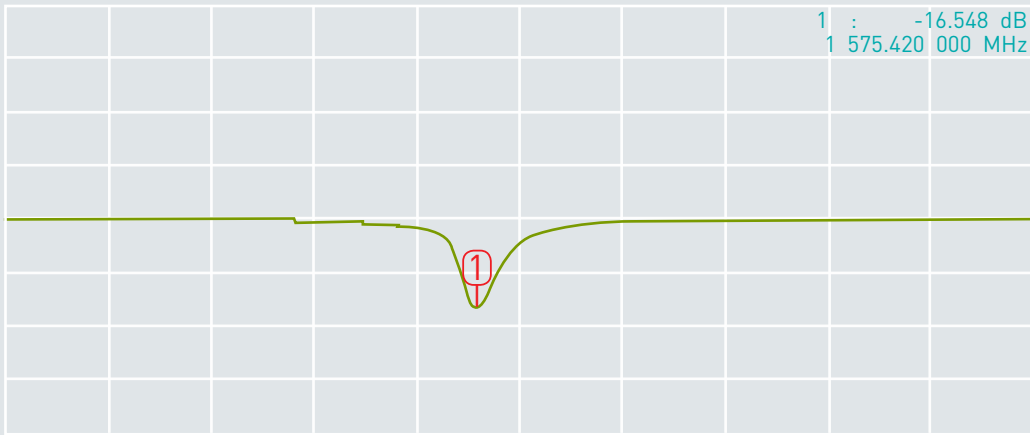

1 300.000 000 MHz 1 900.000 000 MHz

S22 REVERSE REFLECTION TRANSMISSION / REFLECTION
 IMPEDANCE

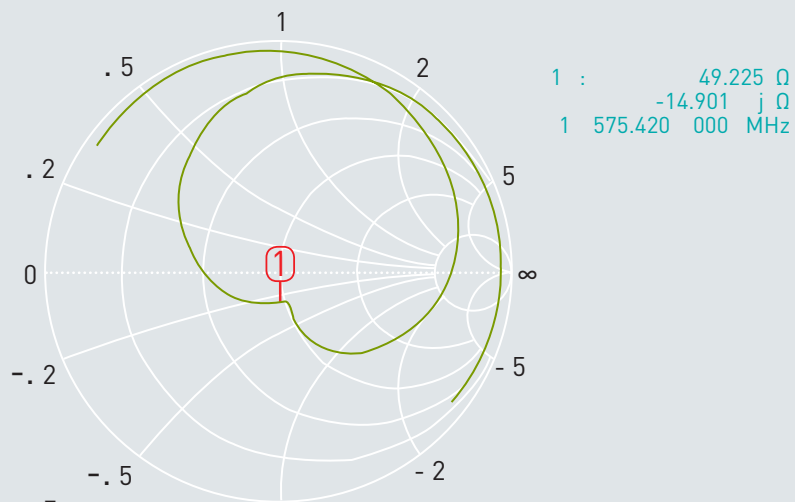

5. Cellular Antenna

1 Active Ch/Trace 2 Response 3 Stimulus 4 Mkr/Analysis 5 Instr State

Tr1 S11 Log Mag 10.00dB/ Ref 0.000dB (F2)

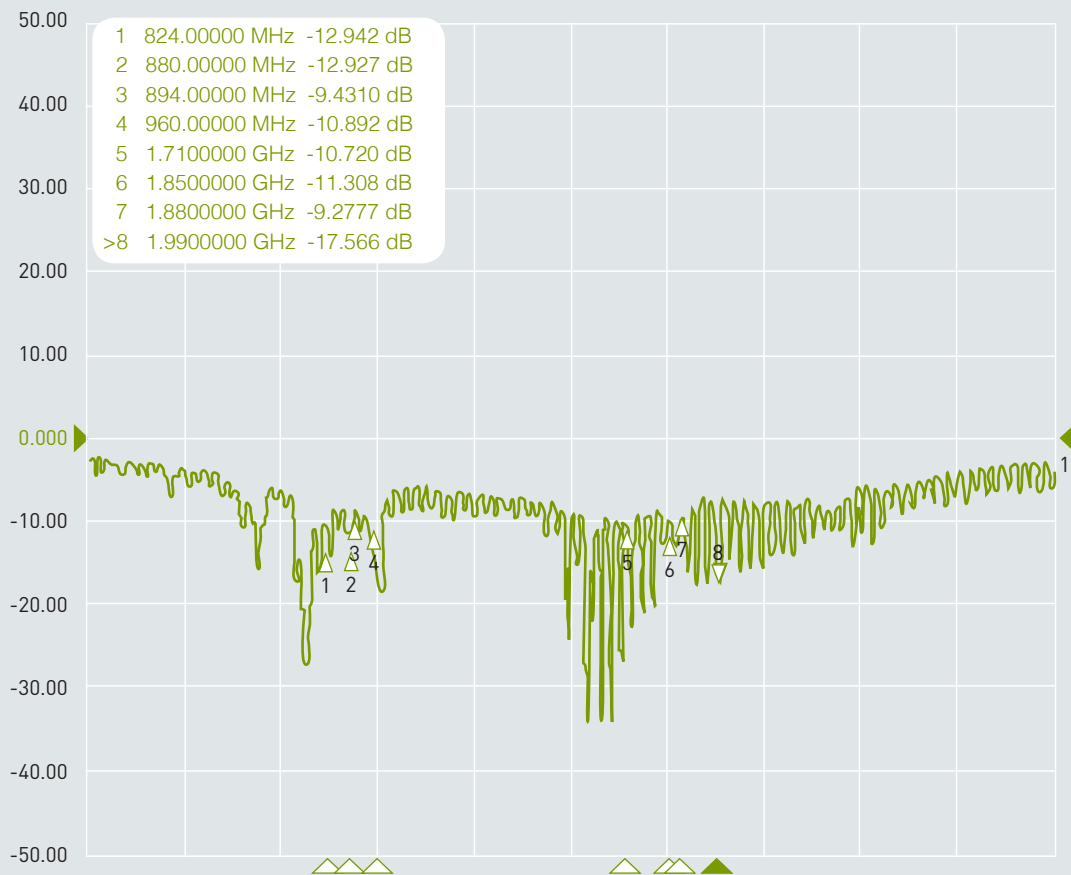

1 Start 100 MHz

IFBW 30 kHz

Stop 3 GHz Cor !

6. LNA gain

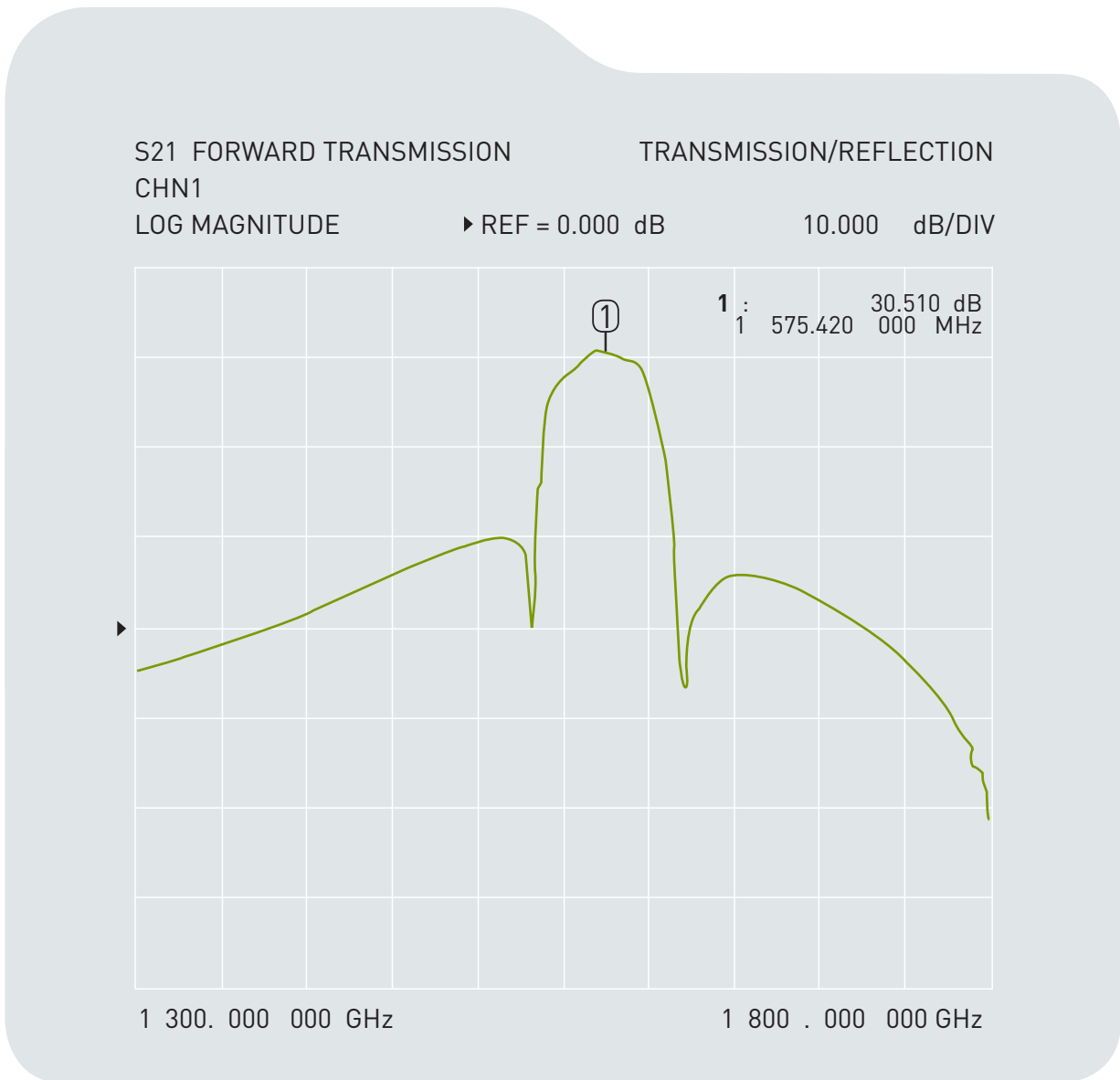

7. LNA S22

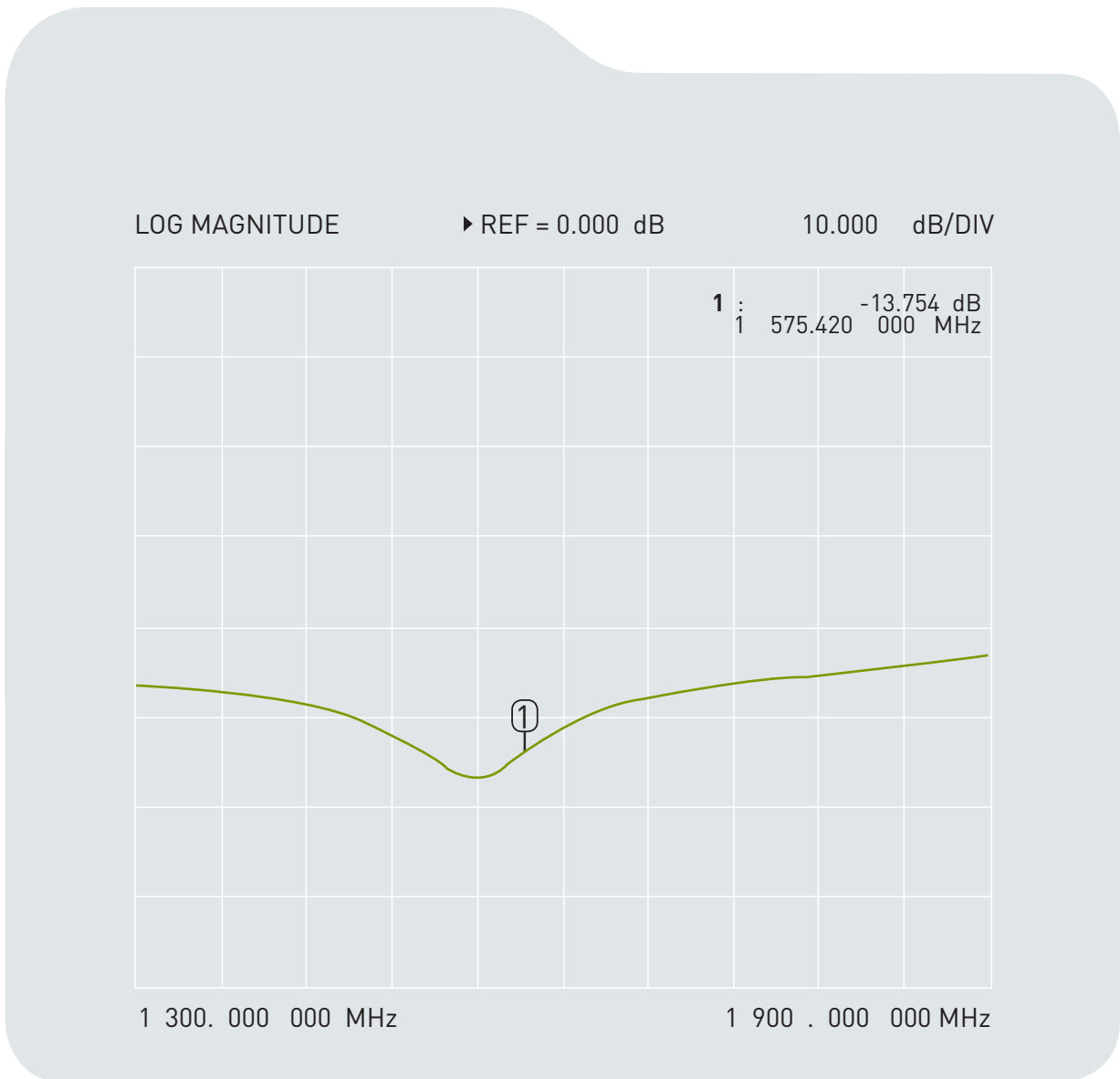

8.1 Cellular Antenna Radiation Pattern

Frequency

XZ Plane

YZ Plane

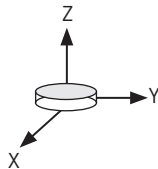

824 MHz

Peak Gain: 1.526 dBi

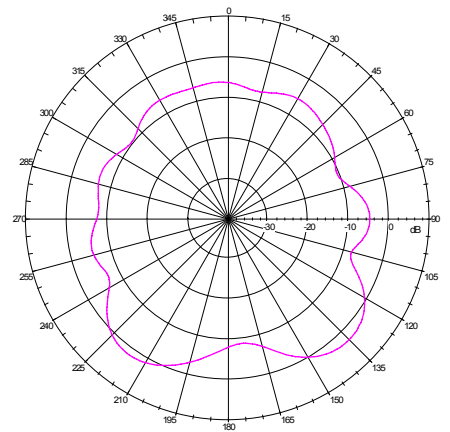
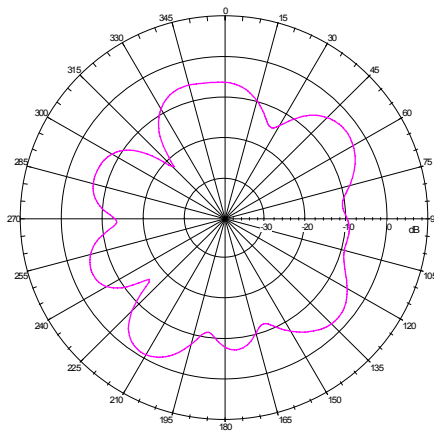

880 MHz

Peak Gain: 1.996 dBi

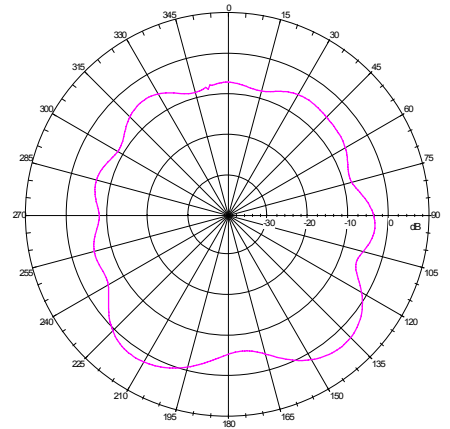
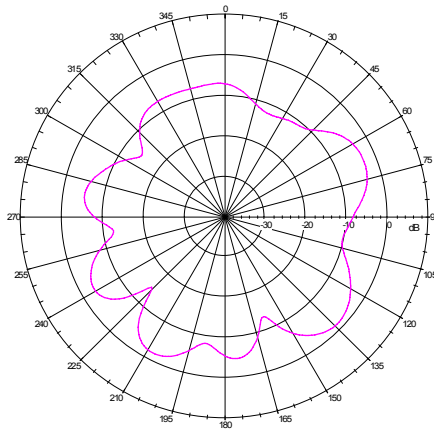

960 MHz

Peak Gain: 1.133 dBi

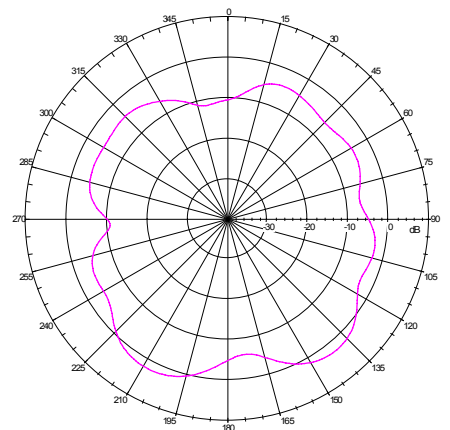
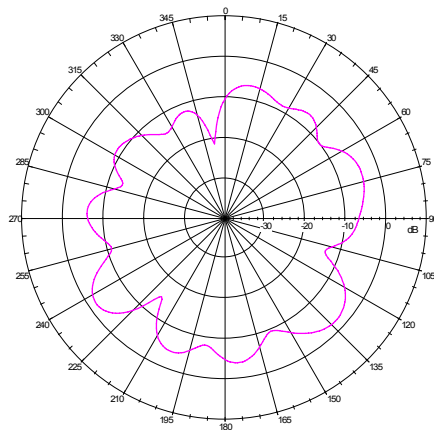

8.2 Cellular Antenna Radiation Pattern

Frequency

XZ Plane

YZ Plane

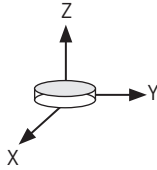

1710 MHz

Peak Gain: 1.946 dBi

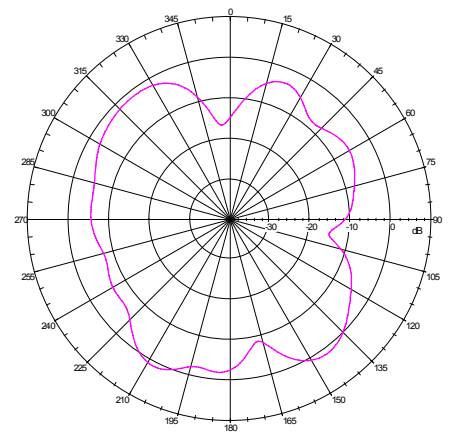
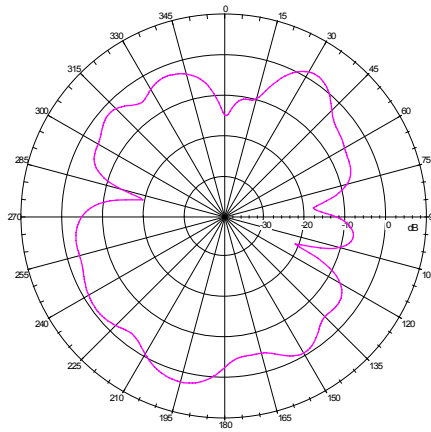

1850 MHz

Peak Gain: 3.0 dBi

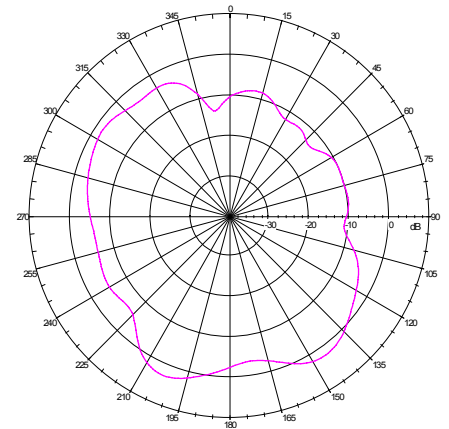
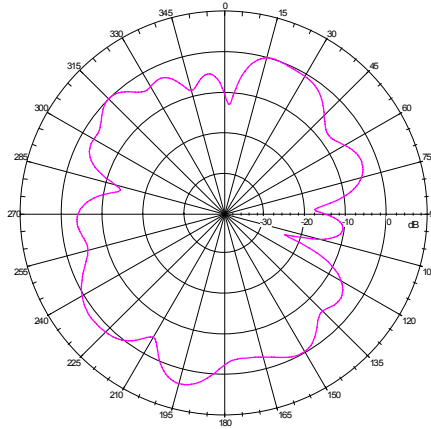

1880 MHz

Peak Gain: 3 dBi

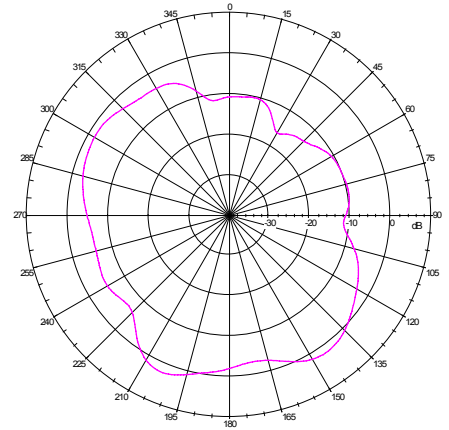
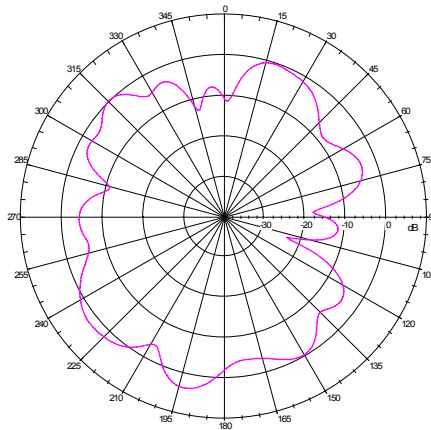

8.3 Cellular Antenna Radiation Pattern

Frequency

XZ Plane

YZ Plane

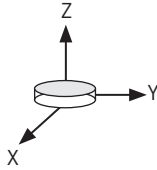

1990 MHz

Peak Gain: 3.27 dBi

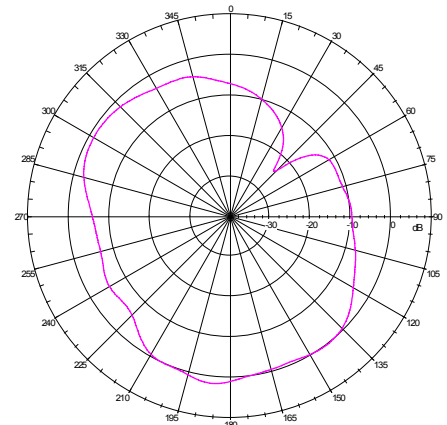
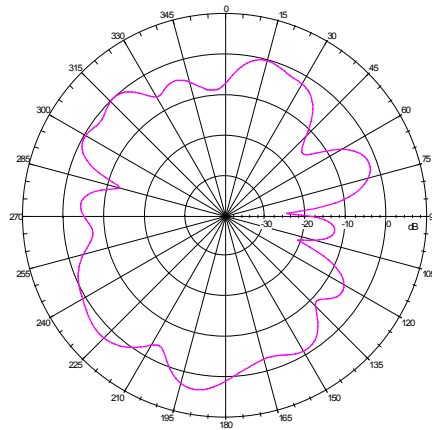

2110 MHz

Peak Gain: 3.78 dBi

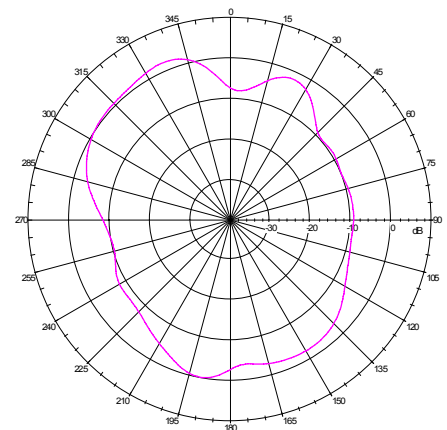
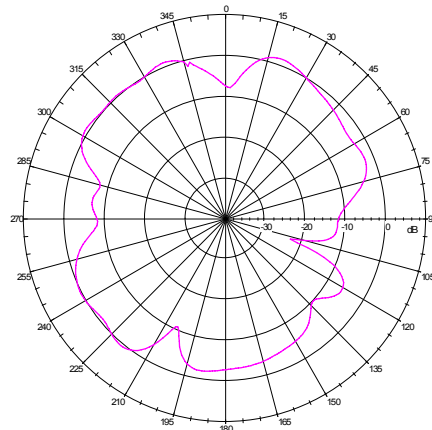

2170 MHz

Peak Gain: 5.82 dBi

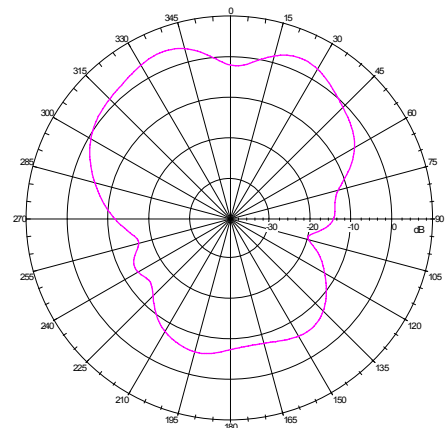
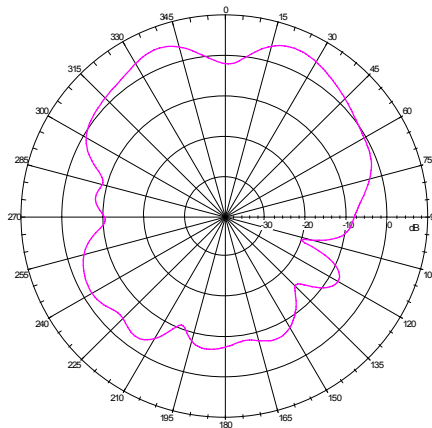

9. Drawing

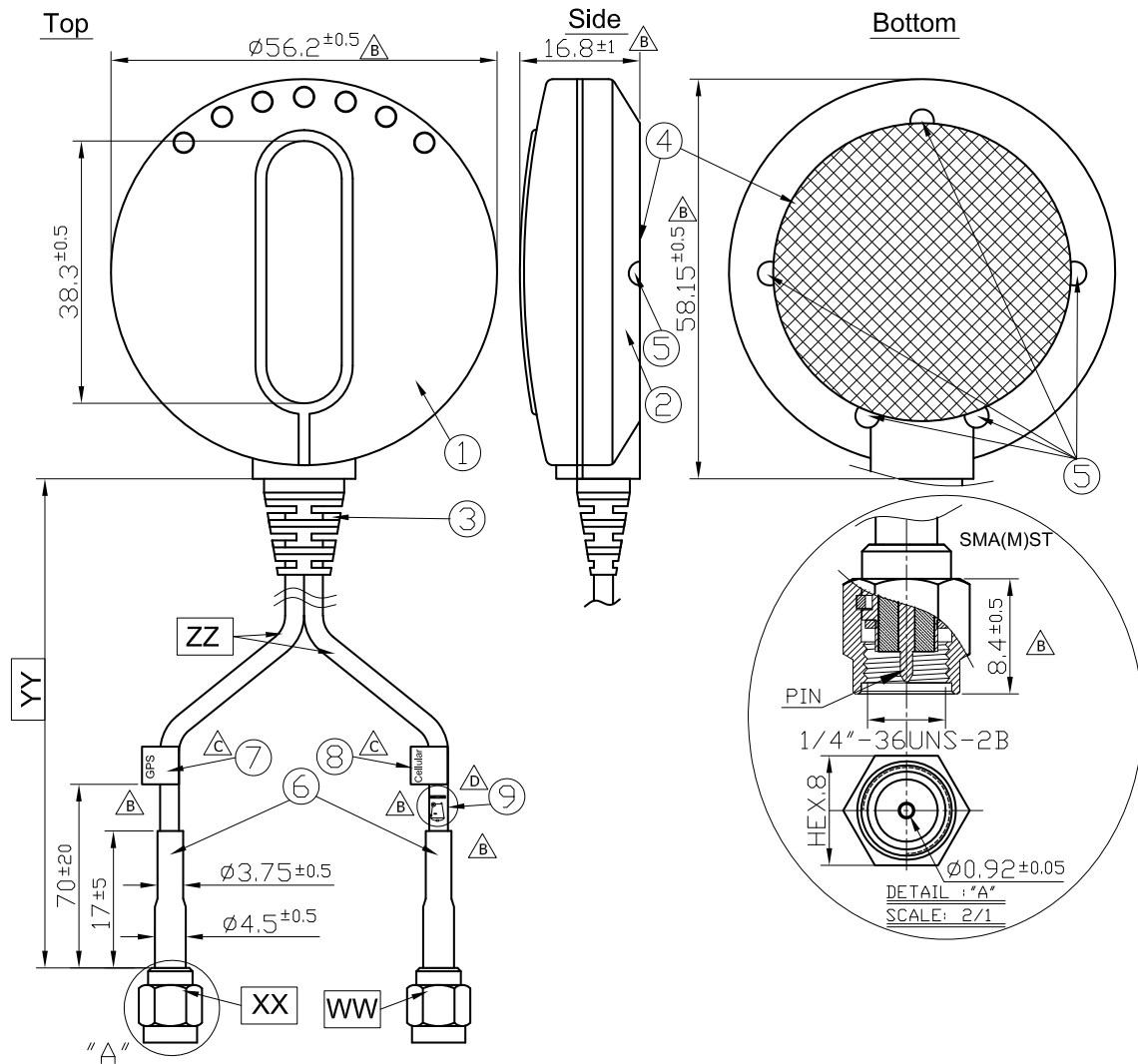

	Name	Material	Finish	QTY
1	Top Housing	ABS	Black	1
2	Bottom Housing	ABS	Black	1
3	SR	PVC	Black	1
4	Sticker	Matte Silver PET	Silver	1
5	2.6L Screw	Stainless Steel	Clear	5
6	Heat Shrink Tube	PE	Black	2
7	GPS Label	Coated Paper	Orange	1
8	Cellular Label	Coated Paper	Blue	1
9	WEEEE Label	Coated Paper	White	1

5. Packaging

1 pcs antenna per small PE bag
80 small PE bag per box

Unit : mm

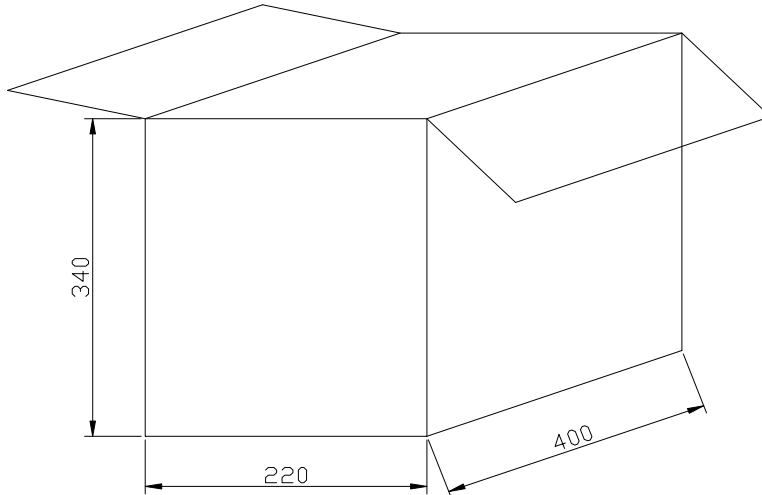
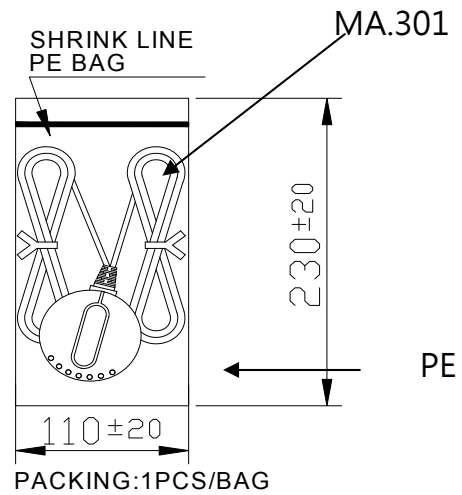

Taoglas makes no warranties based on the accuracy or completeness of the contents of this document and reserves the right to make changes to specifications and

product descriptions at any time without notice. Taoglas reserves all rights to this document and the information

contained herein. Reproduction, use or disclosure to third parties without express permission is strictly prohibited. Copyright © Taoglas Ltd.